

ffgggh



EFFECT OF PARTITIVE VARIATION TEACHING STRATEGY ON PUPIL'S MOTIVATION AND PERFORMANCE IN BASIC SCHOOL ALGEBRA IN BENUE STATE, NIGERIA

Clement Orverlgyu; Martha Mimi Chianson-Akaa; Iorhemem John
Kyeleve&Benjamin IorstwamImoko
Department of Science and Mathematics Education
Benue State University, Makurdi, Nigeria

ABSTRACT

This study investigated the effect of partitive variation teaching strategy on pupils' motivation and academic performance in basic five algebra in Benue state, Nigeria. The quasi experimental, pretest-posttest design was adopted for the research. Four schools were systematically selected in Zone B education zone of the state. There were 113 pupils (54 male, 59 female) in the experimental group and 141 pupils (77 male, 64 female) in the control group. Two research questions and two hypotheses guided the study. There were two instruments used for the study: the algebra performance test (APT) which was an objective test and the Algebra Motivation Questionnaire (AMQ). These were administered on the respondents before and after teaching using carefully prepared lesson plans for both groups of pupils. The experimental procedure took 6 weeks from training to completion. The data collected were analysed using SPSS for Windows analytical software. Means and standard deviations were used to answer the research questions. The multivariate analysis of covariance (MANCOVA) was used to compare the means of motivation ratings, while analysis of covariance (ANCOVA) was used to test the hypotheses at 0.05 level of significance. Findings revealed that there was statistically significant difference $F(6,490) = 44.64$; $P = 0.00 < 0.05$ in the mean motivation ratings and mean performance $F(3,245) = 43.12$; $P = 0.00 < 0.05$ between the experimental and control groups. The study concluded that the partitive variation teaching strategy motivates pupils and improves algebra performance among Basic 5 pupils.

Keywords: partitive variation, motivation, performance, algebra, Basic school

INTRODUCTION

Mathematics education undoubtedly takes center stage in a world of unending scientific and technological advancements, as human kind continually seeks answers to questions about its needs and those of the society. Countries continue to place premium on the teaching and learning of school mathematics. Students need to acquire mathematical

knowledge and skills to compete and survive in life as well contribute their own quota to their immediate society and the world at large. These skills include logical reasoning, problem solving, and the ability to think in abstract ways. The challenge in education today however, is to effectively teach students of diverse ability and different pace of learning so they are able to learn mathematics by developing positive motivation and improved performances in mathematics learning.

Motivational theories seek to investigate what gets individuals to move towards what activities and to describe the characteristics of these activities (Pantziara & Philipou, 2015). Motivation is defined as an internal state that arouses, directs, and maintains behavior, but simply stated motivation is a reason of students' thinking in a given situation (Garut, 2011). Motivation may also be seen as a theoretical concept utilized to clarify human behaviour. It provides the motive for human beings to react and fulfill their needs (Gopalan, Bakar, Zulkifli, & Mat, 2017). The question of how to motivate students in the classroom has become a leading concern for teachers of all disciplines.

Addressing the issue of content, Iji and Omenka (2015) found that the responses of the subjects involved in their study showed poor agreement in the classifications of the mathematics concepts in algebra, number and numeration, geometry, trigonometry and statistics. The high rate of failure in public examination in Nigeria remains a huge problem to researchers, teachers and indeed all stakeholders in education. Studies have identified factors responsible for the high rates of failure to include among others, students' negative attitude to the subject, lack of qualified teachers, inadequacy of teachers, lack of necessary learning skills, specialized language of the subject and inadequate and unsuitable textbooks. Also, it has been established that there is a significant relationship between teachers' method of teaching, teachers' attitude and students' achievement in mathematics (Avong, 2013; Daso, 2013).

The variation teaching strategy which is based on the variation theory is one of those novel teaching strategies employed by mathematics teachers. Variation theory is a theory of learning and experience that



explains how a learner might come to see, understand, or experience a given phenomenon in a certain way and why two students sitting in the same class might come to understand a concept differently. It is a necessary component in teaching in order for students to notice what is to be learned (Bussey, Orgill&Crippen, 2012; Learning Project Team of HKU, 2011; Kullberg, Kempe&Marton, 2017).

Lai and Murray (2013) opine that procedural variation is derived from three forms of problem solving in algebra: Varying a problem; extending the original problem by varying the conditions, changing the results and generalization. Partitive Variation Teaching Strategy (PVTs) is when a part or parts of a particular problem are held constant, while other parts are changed. For example, given $y = 2$, evaluate:

- a. $5y$
- b. $5y - 3$
- c. $5y^2 - 3$
- d. $5y^2)^2 - 3$

It can be used to address individual differences in the classroom by allowing students to draw upon their personal experiences and apply them in their learning (Cheng, 2016). Random Variation Teaching Strategy (RVTS) on the other hand refers to the teaching of algebra, in which cases, entire set of problems come with a varied structures. For example, given that $y = 2$, evaluate:

- a. $x + 5$
- b. $4x - 9$
- c. $3x^2 + 7$
- d. $9(x - 2)$

The object of learning for both examples is to evaluate algebraic expressions by substituting letters for numbers. A mathematics pedagogy that is rooted in variation is one that purposefully provides

learners with the means to experience variation through strategically designed activities in order to create a mathematically rich learning environment that allows learners to discern the object of learning. It is defined by its critical features that must be discerned in order to constitute the meaning aimed for. So as a pedagogic approach, a pattern of variation is a useful tool for structuring teaching to make the learning of the object of learning possible (Mhlolo, 2013). This ultimately leads to improved performances as evidenced by a number of studies.

The study by Ifelunni, Ugwu, Aneke, Ibiām, Ngwoke, Ezema, Charles, Oraelosi, & Ede (2019) investigated motivation as a determinant of academic achievement of primary school pupils in Mathematics in South-East, Nigeria. A population of 357,115 primary 5 pupils in all the 5,378 public primary schools in South-East, Nigeria was used for the study. The sample for the study comprised 400 primary 5 pupils. The findings of the study revealed, among others that there is a significant correlation between intrinsic motivation and primary school pupil's academic achievement. Liu (2018) carried out a study on "Potential reciprocal relationship between motivation and achievement: A longitudinal study". It included students from 1,052 high schools across the United States. Motivation had a greater influence on follow-up mathematics achievement ($O.079$, $p < 0.001$). Jing, Tarmizi, Bakar and Aralas (2017) investigated the effect of utilizing Variation Theory Based Strategy on students' algebraic achievement and motivation in learning algebra. The study used quasi-experimental non-equivalent control group research design and involved 56 Form Two (Secondary Two) students in two classes (28 in experimental group, 28 in control group) in Malaysia. Result from analysis of covariance (ANCOVA) indicated that the experimental group students achieved significantly better test scores than the control group. In addition, result of Multivariate Analysis of Variance (MANOVA) also showed evidences of significant effect of VTBS on experimental students' overall motivation. These results suggested the utilization of VTBS would improve students' learning in algebra. Effect of integrated curriculum delivery strategy on



secondary school students' achievement and retention in Algebra in Benue state was experimented by Anyor and Iji (2010). The population comprised 1,368 Senior Secondary 1 students out of which 149 were purposively sampled. The study found among other things that Integrated Curriculum Delivery Strategy (ICDS) enhanced students' achievement and retention in algebra taught during the course of the study. The ICDS highlighted the importance of creativity which is akin to the partitive variation teaching strategy, in the teaching and learning of algebra in schools. These empirical studies provided gaps and conclusions which were further investigated in the present study.

The following research questions guided the study:

- i. What is the effect of the PVTs on the mean motivation ratings of Basic 5 pupils as compared to those taught using the RVTs?
- ii. What is the effect of the PVTs on the mean algebraic performance of Basic 5 pupils as compared to those taught using RVTs?

Two corresponding null hypotheses were formulated and tested at 0.05 level of significance:

- i. There is no significant effect of the PVTs on the mean motivation ratings of Basic 5 pupils as compared to those taught using the RVTs.
- ii. There is no significant effect of the PVTs on the mean algebraic performance of Basic 5 pupils as compared to those taught using RVTs.

MATERIAL AND METHODS

The quasi experimental, pretest-posttest, control group design is adopted for the study. This design is seen as suitable due to the inability to manipulate and randomize the respondents who were primary school pupils studying in Basic Five. Denga (2017) posited that quasi-experimental studies are conducted under conditions that do not permit control, manipulation of variables or random selection. Random assignment can be achieved but the intact groups coupled with administrative constraints (random selection may lead to a disruption

of school organization and classes) do not allow randomization, control or manipulation. It is an investigation of the effectiveness of a teaching method where random selection of subjects is not possible being a good example, in this study, the Partitive Variation Teaching Strategy.

The area of study is Benue Education Zone B, also called Benue North West Senatorial Zone. The population comprised 20,895 pupils from 1,804 primary schools in Zone B education zone of Benue state (SUBEB, Makurdi, 2019). The sample for this study was 254 pupils. There was a total of 113 pupils (54 male and 59 female) in the experimental group, while the control group had 141 pupils (77 male and 64 female).

Procedure Methodology

The study made use of 2 instruments: Algebra Motivation Questionnaire (AMQ) and the Algebra Performance Test (APT). The AMQ was a 30-item motivation questionnaire containing both pleasant (positively skewed) and unpleasant (negatively skewed) items, designed by the researcher. The Algebra Performance Test (APT) was a 20-item test set by the researcher. There were 2 sets of lesson plans for the research in each sub-topic treated, one for the Partitive Variation Teaching Strategy (experimental group) and the other for the Random Variation Teaching Strategy (control group). Some lesson plans were for a period of 1 hour, while others were for 30 minutes.

Statistical Analysis

The means and standard deviations of the variables studied were used to answer the research questions. The Analysis of Covariance (ANCOVA) was used to test the hypotheses relating to students' algebraic performance. Motivation on the other hand, was analysed using Multivariate Analysis of Covariance (MANCOVA) with data obtained from the AMQ. Both hypotheses were tested at 0.05 level of significance.

RESULT

The data is presented according to the objectives of the study. This is done by placing data for a research questions first and followed immediately by the corresponding hypothesis.



Research question one: What is the effect of PVTs on the mean ratings of Basic 5 pupils' motivation as compared to those taught using the RVTs?

Table 1: Descriptive statistics for mean motivation ratings in the experimental and control groups

	Motivation	Experimental (N = 113)		Control (N = 141)	
		Mean	Std. Dev.	Mean	Std. Dev.
Posttest	Attention	3.62	0.25	2.26	0.38
	Relevance	3.29	0.34	2.73	0.38
	Confidence	3.04	0.42	2.85	0.43
	Satisfaction	3.10	0.44	2.86	0.37
	Interest	3.22	0.35	2.71	0.41
	Total	3.26	0.42	2.68	0.45
Pretest	Attention	2.49	0.37	2.36	0.32
	Relevance	2.84	0.35	2.56	0.30
	Confidence	2.94	0.43	2.90	0.42
	Satisfaction	2.91	0.42	2.83	0.43
	Interest	2.94	0.41	2.67	0.37
	Total	2.83	0.43	2.66	0.42

Results in *Table 1* display the means and standard deviations of the responses with respect to motivation of pupils in the experimental and control groups. It reveals that in the experimental group, the pupils consistently improved individually and in the total means (2.83 to 3.26) while the standard deviation got smaller from 0.43 to 0.42 which shows an improvement in the data distribution across the sub-scales of attention, relevance, confidence, satisfaction and interest. Results in the table also illustrate the means and standard deviations of the responses with respect to motivation of pupils in the control group. It reveals that the pupils appear to have responded in a similar fashion individually and in the total means (2.66 and 2.68). The standard deviations were 0.42 and 0.45 across the sub-scales of attention, relevance, confidence, satisfaction and interest. The standard deviations in both groups showed elements of homogeneity in their responses.

Effect of Partitive Variation Teaching Strategy on Pupil's Motivation and Performance in Basic School Algebra in Benue State, Nigeria

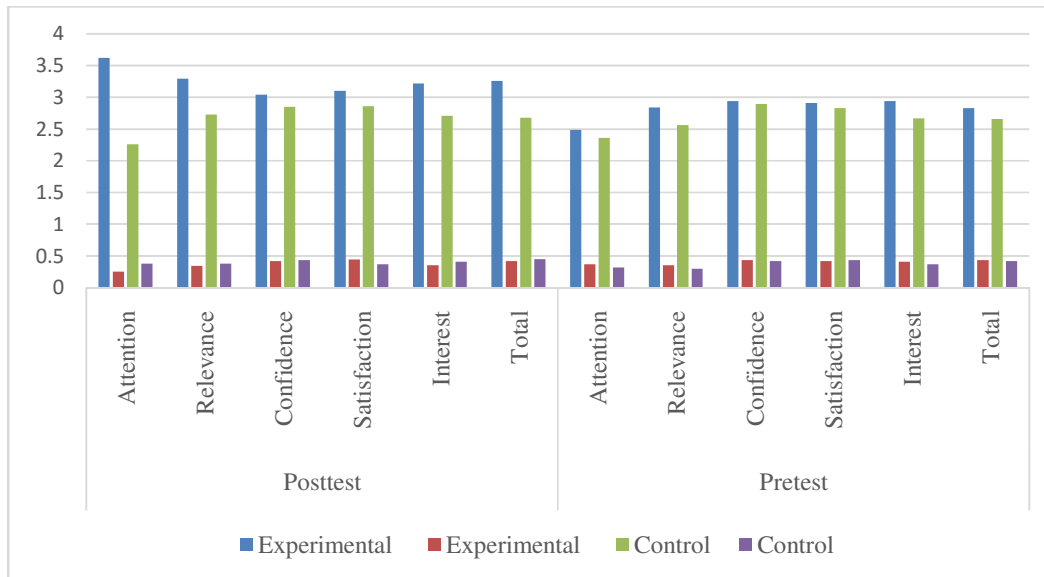

Figure 1: Bar chart for mean motivation ratings in the experimental and control groups

The figure is a pictorial representation of Table 1. It displays the means and standard deviations of the experimental group in blue and red respectively, while the means and standard deviations of the control group are displayed in green and purple respectively.

Table 2: Descriptive statistics for the motivation responses of pupils in the four sub-groups

	Group	Mean	Std. Deviation	N
Posttest	Experimental1	3.26	0.22	71
	Experimental2	3.25	0.19	42
	Control1	2.68	0.27	34
	Control2	2.68	0.27	107
Pretest	Experimental1	2.81	0.28	71
	Experimental2	2.86	0.24	42
	Control1	2.67	0.25	34
	Control2	2.66	0.24	107

Results in Table 2 show that the mean responses of the pupils in Experimental Group One increased from 2.81 in the pretest to 3.26 in the posttest, with standard deviations of 0.28 and 0.22 respectively. In the Experimental Group Two, the pupils had a mean response on 2.86 in the pretest and increased to 3.25 in the posttest, with standard deviations of 0.24 and 0.19 respectively. In the Control Group One, the



pupils had mean response of 2.67 in the pretest and 2.68 in the posttest with standard deviations of 0.25 and 0.27 respectively. The mean response of the pupils in Control Group Two was 2.66 with a standard deviation of 0.24, in the pretest and mean of 2.68 and standard deviation of 0.27 in the posttest, this demonstrated an almost static response in the control group.

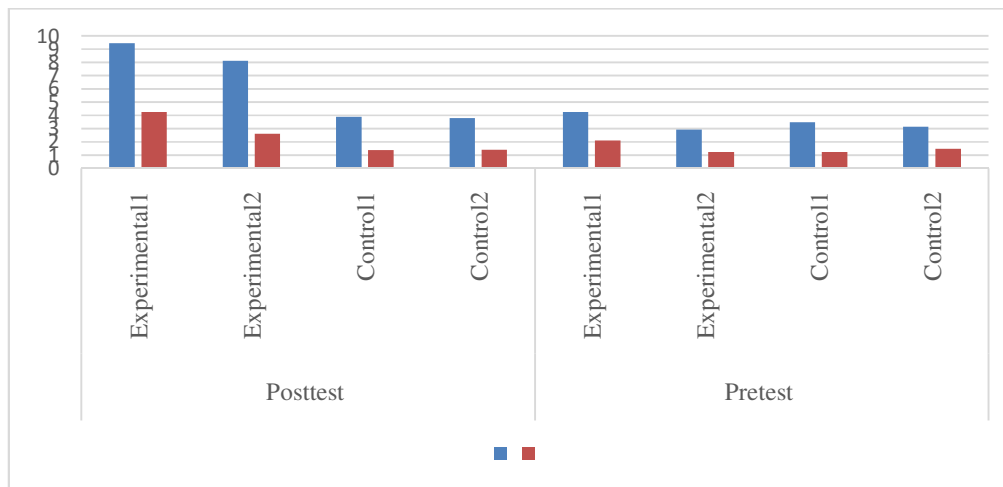

Figure 2: Bar chart for the motivation responses of pupils in the four sub-groups

The bar chart in *Figure 2* illustrates the mean and standard deviations of the mean motivation ratings of the pupils in the experimental and control groups as individual groups.

Table 3: Summary descriptive statistics for mean motivation ratings according to the experimental and control groups

Group	N	Pretest		Posttest		Mean Gain
		Mean	S.D.	Mean	S.D.	
Experimental	113	2.83	0.43	3.26	0.42	0.43
Control	141	2.66	0.42	2.68	0.45	0.02
Mean difference		0.17		0.58		0.41

The experimental and control groups had a mean motivation rating of 2.83 and 2.66 in the pretest respectively with a mean difference of 0.17 in favour of the experimental group. The data also showed that the pupils in the two groups had corresponding means of 3.26 and 2.68 in the posttest, this gave a mean difference of 0.58, also in favour of the

experimental group. There was a mean gain of 0.43 for the experimental group to the control group's mean gain of 0.02, which gave rise to a mean gain difference between the groups of 0.41. The standard deviation for the experimental group (0.42) was smaller than those of the control group (0.45) in the posttest; this indicates that the responses of the pupils in the experimental group were more homogenous than those in the control group. This depicts a positive effect of the PVTs motivation of pupils in learning algebra among the sample of pupils, to answer the research question.

Hypothesis one: There is no significant effect of the PVTs on the mean motivation ratings of Basic 5 pupils as compared to those taught using the RVTs

Table 4: Summary of multivariate tests for mean motivation ratings between the experimental and control groups

Effect	Value	F	Hypothesis			
			df	Error df	Sig.	
Groups	Pillai's Trace	0.59	33.94	6	492	0.00
	Wilks' Lambda	0.42	44.64	6	490	0.00
	Hotelling's Trace	1.38	56.26	6	488	0.00
	Roy's Largest Root	1.38	112.93	3	246	0.00

The data is interpreted using Wilks' Lambda, the recommended measure (Lund & Lund, 2020) for a multivariate statistic (MANCOVA) for the study. Data in *Table 4* shows that there is a statistically significant difference $F(6, 490) = 44.64$ and $p = 0.00 < 0.05$ in the mean motivation rating of the respondents. The research hypothesis one is therefore rejected, which implies that the mean motivation ratings of pupils taught using the PVTs differ significantly from those taught using the RVTs. This suggests that the pupils showed greater attention, relevance, confidence, satisfaction and interest in the learning of algebra when taught using the intervention strategy.



Research question two: What is the effect of the PVTs on the mean score of Basic 5 pupils' algebraic performance as compared to those exposed to RVTs?

Table 5: Descriptive statistics showing the mean scores at APT in the experimental and control groups in terms of the four sub-groups

	Group	Mean	Std. Deviation	N
Posttest	Experimental1	18.99	7.74	71
	Experimental2	21.05	9.95	42
	Control1	9.82	3.79	34
	Control2	9.81	3.69	107
Pretest	Experimental1	11.10	5.70	71
	Experimental2	8.86	2.58	42
	Control1	8.38	3.04	34
	Control2	7.48	3.54	107

Results in Table 5 reveal the means and standard deviations of the 4 sub-groups in terms of the algebra performance test. The Experimental Group One had a mean of 11.10 in the pretest with a standard deviation of 5.70 and a mean of 18.99 and standard deviation of 7.74. The Experimental Group Two had a mean of 8.86 and 21.05 in the pretest and posttest respectively, with standard deviations of 2.58 and 9.45. The Control Group One had a mean of 8.38 in the pretest and 9.82 in the posttest, with standard deviations of 3.04 and 3.79 respectively. The Control Group Two had a mean of 7.48 in the pretest and 9.81 in the posttest, with corresponding standard deviations of 3.54 and 3.69 respectively. On the whole, the two groups demonstrated similar data characteristics going by their standard deviations. However, there appears to be a disproportionate data behaviour in Experimental Group Two, where the standard deviation in the posttest appears abnormal to the other results in relation to the mean and total number of respondents.

Effect of Partitive Variation Teaching Strategy on Pupil's Motivation and Performance in Basic School Algebra in Benue State, Nigeria

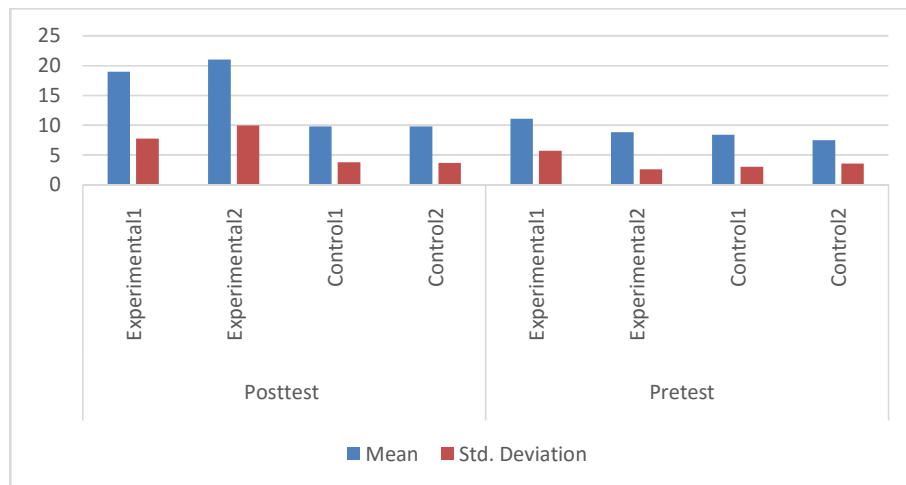

Figure 3: Bar chart showing the mean scores at APT in the experimental and control groups in terms of the four sub-groups

The means in blue and standard deviations in red illustrate the scores of pupils in the groups with respect to the pretest and posttest performance.

Table 6: Summary descriptive statistics showing the mean difference between the experimental and control group at APT

Group	N	Pretest		Posttest		Mean Gain
		Mean	S.D.	Mean	S.D.	
Experimental	113	9.98	4.14	20.02	8.85	10.04
Control	141	7.93	3.29	9.82	3.74	1.89
Mean difference		2.05		10.20		8.15

Results in *Table 6* shows that pupils in the experimental group had a mean of 9.98 and 20.02 and standard deviation of 4.14 and 8.85 in the pretest and posttest respectively; this gives a mean gain of 10.04 for the experimental group. The control group on the other hand had a mean performance score of 7.93 and 9.82 with standard deviations of 3.29 and 3.74 in the pretest and posttest respectively with a mean gain of 1.89. There was a mean difference of 2.05 and 10.20 in the pretest and posttest, and 8.15 in the mean gain. The standard deviations of the two groups are an indication that the data sets share similar traits, because they fall within the same side and partition of the normal curve. To answer the research question, the PVTs appears to have caused an increased algebraic performance in the APT by pupils in the



experimental group as compared to pupils that were taught using the RVTS.

Hypothesis two: The PVTs has no significant effect on Basic 5 pupils' algebra performance mean score as compared to those taught using the RVTS.

Table 7: Summary tests of between-subjects (experimental and control groups) effects with respect to the APT using posttest as the dependent variable

Source	Type III Sum of Squares	df	Mean Square	F	Sig.
Corrected Model	7433.87	8	929.23	25.18	0.00
Intercept	4701.44	1	4701.44	127.42	0.00
APTpretest	939.46	1	939.46	25.46	0.00
Gender	54.74	1	54.74	1.48	0.22
APT	4773.41	3	1591.14	43.12	0.00
Gender * APT	157.16	3	52.39	1.42	0.24
Error	9039.95	245	36.90		
Total	67952.00	254			
Corrected Total	16473.83	253			

The analysis shown in *Table 7* reveal that there was a statistically significant effect, where $F(3, 245) = 43.12$ and $P = 0.00 < 0.05$ of the PVTs when compared to the RVTS in the mean performance scores of pupils. The null hypothesis is rejected which implies that the PVTs has a significant effect on Basic 5 pupils' algebra performance mean score as compared to those taught using the RVTS.

DISCUSSION

This study found a significant difference in the mean motivation ratings of pupils in the experimental group and the control group in favour of the experimental group which agrees with Jing, Tarmizi, Bakar and Arılas (2017). The findings also agree with Yakubu (2017) who found that pupils with mathematics learning challenge in the treatment group showed higher motivation than pupils in the control group. There were evidences of significant effect of the partitive variation theory-based strategy on experimental students' overall motivation. This indicated that the partitive variation teaching strategy may be capable of triggering both the intrinsic and extrinsic motivation of pupils in the

middle basic level of education in Benue state, Nigeria. This was made more consistent by the more improved mean motivation ratings in the 5 subscales of attention, relevance, comprehension, satisfaction and interest, which the pupils in the experimental group consistent had higher mean responses.

There was statistically significant difference in the performance of students between the experimental group and the control group, which agrees with Anyor and Iji (2010) as well as Jing, Tarmizi, Bakar and Aralas (2017). The positive interaction of organizational culture, education in this case, and human resource management (teaching) would result in self-esteem and self-actualization. Generally, it is agreed that dispositions such as motivation, curiosity and perseverance can be recognised when students persist at difficult tasks, take risks and exhibit open mindedness (Al-Shara, 2015). The findings of this study also agree with those of Liu (2018) as well as Ifelunni, Ugwu, Aneke, Ibiam, Ngwoke, Ezema, Charles, Oraelosi, and Ede (2019) that there is a significant influence of motivation or that there is a potential reciprocal relationship between motivation and academic performance of students. García, Rodríguez, Betts, Areces and González-Castro (2016) stated that Mathematics enjoyment or satisfaction positively predicted mathematics achievement as has been confirmed in this study. Higher motivation ratings which may be due to the partitive variation teaching strategy predicated better algebraic performances among Basic school learners.

CONCLUSION

This study concluded that pupils in the experimental group significantly showed higher motivation ratings and consistently outperformed those in the control group in the algebra performance test. The study further concluded that the partitive variation teaching strategy may be useful for the improvement of algebra teaching and learning in Middle Basic (Basic 5) level of education in Benue state, which may be replicated in other locations.

REFERENCES



- Jing, T. J., Tarmizi, R. A., Bakar, K. A., & Aralas, D. (2017). The adoption of variation theory in the classroom: effect on students' algebraic achievement and motivation to learn. *Electronic Journal of Research in Educational Psychology*, 15(2), 307-325
- Pantziara, M. & Philippou, G. N. (2015). Students' motivation in the mathematics classroom. Revealing causes and consequences. *International Journal of Science and Mathematics Education*, 13(2)
- Garut, P. (2011). *Motivation in learning mathematics*. Retrieved online from <https://p4mriskipgarut.wordpress.com/2011/05/03/motivation-in-learning-mathematics/> on 12th February, 2018
- Gopalan, V., Bakar, J. A. A., Zulkifli, A. N., Alwi, A. & Mat, R. C. (2017). *A review of the motivation theories in learning*. Malaysia: AIP Publishing
- Iji, C. O. & Omenka, J. E (2015). Mathematics teachers' perception of difficult concepts in secondary school mathematics curriculum in Benue state, Nigeria. *Asia Pacific Journal of Education, Arts and Sciences*, 2(1)
- Avong, H. N. (2013). Poor performance in mathematics among senior secondary school students in Kaduna state: what's to blame? *JORIND*, 11(2).
- Daso, P. O. (2013). Teacher variables and senior secondary students' achievement in mathematics in Rivers state, Nigeria. *European Scientific Journal*, 9(10), 1857 – 7881
- Bussey, T. J., Orgill, M. & Crippen, K. J. (2013). *Variation theory: A theory of learning and a useful theoretical framework for chemical education research*. The Royal Society of Chemistry, University of Florida, School of Teaching and Learning, Gainesville, USA
- Learning Project Team of HKU (2011). What teachers should know about learning theories. Retrieved online from https://kb.edu.hku.hk/approaches_variation_theory/ on 22nd March, 2018

- Jerome, N. (2013) Application of the Maslow's hierarchy of need theory; impacts and implications on organizational culture, human resource and employee's performance. *International Journal of Business and Management Invention*, 2(3), 39-48
- Kullberg, A., Kempe, U. R. & Marton, F. (2017). What is made possible to learn when using the variation theory of learning in teaching mathematics? *ZDM Mathematics Education*, 49:559-569
- Lai, M. Y. & Murray, S. (2013). Teaching with Procedural Variation: A Chinese Way of Promoting Deep Understanding of Mathematics. Retrieved online from www.researchoutput.csu.edu
- Cheng, E. W. L (2016). Learning through the Variation Theory: A Case Study. *International Journal of Teaching and Learning in Higher Education*, 28(2), 283-292
- Mhlolo, M. (2013). The merits of teaching mathematics with variation. *Pythagoras*, 34(2), Art. #233, 8 pages.
<http://dx.doi.org/10.4102/pythagoras.34i2.233>
- Anyor, J. W. & Iji, C. O. (2010). Effect of integrated curriculum delivery strategy on secondary school students' achievement and retention in Algebra in Benue state. *Abacus, journal of the Mathematical Association of Nigeria (MAN)*, 39(1), 83-96
- Denga, D. I. (2017). *An introduction to research methods and statistics in education and social studies (4th)*. Calabar: Clearlines Publications Limited
- Lund, A. & Lund, M. (2020). *Two-way ANCOVA in SPSS*. Retrieved online from www.statistics.laerd.com/spss-tutorials/two-way-ancova-using-spss-statistics.php
- Yakubu, I. W. (2017). *Effect of inclusion instructional strategy on motivation and achievement of Middle Basic pupils with mathematics learning challenge in Benue state*. A thesis in the department of Curriculum and Teaching, Benue state University, Makurdi
- Mata, M. L., Monteiro, V. & Peixoto, F. (2012). Attitudes towards mathematics: Effects of individual, motivational, and social support factors. *Child Development Research, Volume 2012, Article ID 876028*, 10 pages



- Al-Shara, I. (2015). Learning and teaching between enjoyment and boredom as realized by the students: a survey from the educational field. *European Scientific Journal* edition, 11(19), 146-168
- Liu, Y. & Hou, S. (2018). Potential reciprocal relationship between motivation and achievement: A longitudinal study. *School Psychology International*, 3(2), 38-55
- Ifelunni, C. O., Ugwu, G. C., Aneke, A. O., Ibiām, J. U., Ngwoke, A. N., Ezema, V. S., Charles A. Oraelosi, C. A. & Ede, M. (2019). Motivation as a Differential Predictor of Mathematics Achievement of Pupils in South-East, Nigeria. *Journal of Engineering and Applied Sciences*, 14: 5345-5350
- García, T., Rodríguez, C., Betts, L., Areces, D., & González-Castro, P. (2016). How affective-motivational variables and approaches to learning relate to mathematics achievement in upper elementary levels. *Learning and Individual Differences*, 49, 25-31.



ANALYSIS OF ERRORS IN COMPLETING SQUARE WHEN SECONDARY SCHOOL STUDENTS SOLVE QUADRATIC EQUATION BY NEWMAN ERROR ANALYSIS PROCEDURE IN NASARAWA STATE

Kyari Sunday Steven
Department of Basic Sciences,
College of Agriculture Science and Technology Lafia, Nasarawa State
Email: stevenskyari@yahoo.com

ABSTRACT

The purpose of this study was to diagnose, using the Newman error analysis model. The error committed when students solve quadratic equation using completing square method. The target population was all SS3 students in Nasarawa State public schools. Three research questions and three hypotheses were answered and tested respectively. Survey design was used for the study. Data collected was analysed using student t-test. The result of the findings showed that all the students committed errors at various stages of Newman model and there is no significance difference in the means of errors committed by SS3 students that solved quadratic equation using completing square method.

INTRODUCTION

The importance given to mathematics in the curriculum from primary to the secondary level reflects the role played by mathematics in contemporary society. It is in understanding of this that many countries now resort to making comprehensive and well programmed efforts towards effective teaching and learning of science and mathematics at all levels of the educational system through the development and implementation of improved programmes and projects (Azuka, 2001). In most schools in Nigeria for example, the study of mathematics is made mandatory for all students. In order to secure admission for most courses at higher levels of education, a credit pass in mathematics is a pre-requisite. In spite of importance of mathematics in human existence, students still perform poorly in the subject. Musa (2014) stressed that West African Examination Council (WAEC) results in mathematics between 2004 and 2013 attest to the candidates' poor performance. In this period, the percentage credit pass and above in mathematics at the Senior Secondary Certificate Examination (SSCE) level ranges about 40% pass. The West Africa Examination Council

(WAEC) Chief Examiners Report consistently reported lack of skill in answering almost all the questions asked in general mathematics. The most affected areas include, geometry of 3-dimensional problems, algebraic expression (quadratic equation) and words problems in equations, statistics and percentage errors to mention a few. In specific terms the examiners reported students' weaknesses in quadratic equation. Some areas of the syllabus that were also reported to be poorly attempted by candidates were the reading and drawing of quadratic graph among others. The weakness is also evident in the Chief Examiners' reports of WASSCE 2012, 2013, 2015, 2016 and 2018. In view of these general weak performances of students in mathematics, efforts are being made every now and then by mathematics educators at various quarter to bring mathematics teaching and learning meaningful. This is observed in the trends of workshops for teachers of mathematics and different research works in areas of teaching, student achievement in mathematics, attitude of students towards the subject and strategies to improve on the teaching and learning of mathematics. Learners are evaluated thereof on the way they conceive the concepts in mathematics and the quality of teaching. This will help to reveal learner errors and misconceptions (Riccomini, 2005). According to Riccomini, Mathematics teachers do not treat learner errors committed when solving mathematical problems seriously. He also said teachers do not have courage and patience to investigate learners' errors and problems experienced in solving mathematical problems.

Error can be defined here as a way of doing a thing wrongly. Reviewing the research method on errors, specifically, classifying students' errors based on the step of solving problems or the sources of difficulties in solving problems. Students correctly follow wrong algorithms, which is contrary to many teachers views that students wrongly follow an algorithm. This study focuses on where the error originated, which is linked between conceptual and procedural knowledge. One of the main methods used to analyze student's errors is to classify them into certain categorization based on analysis of students' mistakes. The errors are classified in terms of Language difficulties, difficulties in the processing



iconic and visual representation of mathematical knowledge, deficiency in the requisite skill, facts, and concepts; for example, student may forget or be unable to recall related information in solving problems, incorrect association rigidity; that is negative transfer caused by decoding and encoding information and application of irrelevant rules or strategies. Titus (2016) also used the classifying method but based his own on the model of problem solving (Polyer). He thought that Students errors may be due to deficiency in one or more of the above steps.

Analysis of error is the ability to establish the existence of errors in a computation. There are many factors that help students to turn up at a correct result while solving mathematical problems. The method is based on the fact that in the process of problem solving there are two major types of hurdles that hinder students from arriving at correct answers. They are; troubles in reading fluency and abstract understanding that helps reading and understanding meaning of problems. The other one is trouble of processing mathematical problems that consist of transformation, process skill, and encoding results. It is important to find where students commit such errors and continue to repeat them. Studies have been conducted over years to determine the predictor of mathematics achievement among various groups of individuals. Some of the predictions are, socio-economic status of students, teaching methods teachers use, gender and environmental factors of students among others (Owolabi and Adejoke, 2014; Adeyinka and Kaino, 2014). One variable that has over the years, received considerable attention in many studies on science achievement in general and mathematics achievement in particular is gender. According to Owolabi and Adejoke (2014) studies conducted among middle and high school students show a significant gender effect favoring males in overall sciences and mathematic achievement. They also said in another study that boys outperform girls in science but in reading and writing, girls had the advantage. Abubakar and Oguguo (2011) study show no significant difference in gender achievement in relation to Number and

Numeration, Algebraic process and statistics. However, in some studies, both male and female perform at par having applied certain strategies (Adeleke, 2007).

Another variable which is of interest in this study is school location. There are different school locations in Nasarawa state which include urban, semi-urban rural or remote villages. The results of some studies outside the shores of Nigeria have shown that location is a variable to consider on students' achievement, example is Indonesia, Jambi province. Effandi and Siti (2010) attest that students in rural schools perform poorly in mathematics at the point of comprehension, given that the effect of mother tongue or bilingual conflict is prominent. The urban schools more errors are committed at the process skill and transformation stage.

One other factor the researcher considered is the student academic orientation (Science/arts). The orientation of the students may or may not narrow their understanding of specific concepts and will not be able to engage them in problem solving. Students who do not have background knowledge in mathematics usually display numerous errors in solving mathematical problems and this therefore results in most students grappling with quadratic equations (Sello, 2014). If a research could characterize students learning difficulties, it would be possible to design effective instruments to enhance students learning. The research on student's errors is a way to provide such support for both teachers and students. Li (2006), pointed out one way of trying to find out what makes algebra difficult is to identify the kind of errors students commit. There was also need to classify the errors based on the steps of solving problems. He reported that Radatz first classified students' errors in terms of language difficulties, mathematics is like a foreign language for students who needs to know and understand mathematical concepts, symbol, and vocabulary. Misunderstanding the logic for mathematics language could cause students error at the beginning of problem solving, difficulties in processing the representation of mathematical knowledge, like of requisite skills, knowledge, and concepts, poor associations or rigidity; that is, wrong transfer caused by decoding and encoding information and application of irrelevant rules or strategies.



Anne Newman (1980) than used the classifying method but based her model on problem solving.

The model of the sequence of steps in problem solving: reading and comprehension, transformation, process skill, and encoding to identify students' possible errors. She thought that student's error may be due to deficiency in one or several of the above steps. This is what is today referred to as Newman error analysis procedure (Newman Model) which the researcher will adopt to diagnose errors students commit by senior secondary school three when solving quadratic equation by completing square method.

STATEMENT OF THE PROBLEM

In SSCE mathematics examination, students have presented difficulties in solving equations. The Chief Examiner's Report of 2011 to 2017 all emphasized that students are weak in algebraic process; Quadratic equation is one topic that every year WASSCE features to test the concept among students and also to test their procedural understanding of quadratic equations. These mistakes lower students' achievement in SSCE Mathematics achievement it is therefore important to identify the types of errors students commit and where they commit them. The Newman Model; Newman Error Analysis Procedure has been found useful for analyzing students' errors when solving quadratic equations since it takes them through the steps needed to reach the solution. The focus of this study therefore was to analysis the errors committed when senior secondary school students solve quadratic equations by completing square method using Newman error analysis procedure.

OBJECTIVES OF THE STUDY

The objectives of this study were using Newman Error Analysis procedure;

1. compare the means and standard deviations of errors committed by male and female senior secondary school (SS3) students' when solving quadratic equation by completing square method

2. established the means and standard deviations of errors committed by urban and rural senior secondary school (SS3) students committed when solving quadratic equation using method of completing square
3. compare the means and standard deviation of errors committed by Science and Art senior secondary school (SS3) students' when solving quadratic equations using the method of completing square.

RESEARCH QUESTIONS

The following research questions guided the study.

Using Newman error analysis Procedure;

1. what are the means and standard deviations of errors committed by male and female senior secondary school three (SS3) students' when solving quadratic equations by completing square method?
2. what are the mean and standard deviations of errors committed by senior secondary school three (SS3) students' in the urban and rural areas when solving quadratic equation using completing square?
3. what are the mean and standard deviations of errors committed by science and arts senior secondary school three (SS3) students' when solving quadratic equation by completing square method?

STATEMENT OF HYPOTHESES

The following null hypotheses were tested at 0.05 level of significance.

Using Newman error analysis procedures;

- Ho₁:** There is no significant difference in the mean scores of errors committed by male and female senior secondary school students' when solving quadratic equations by completing square method
- Ho₂:** There is no significant difference in the mean scores of errors committed by urban and rural senior secondary school students' when solving quadratic equation using completing square method
- Ho₃:** There is no significant difference in the mean scores of errors committed by Science and Art senior secondary school students' when solving quadratic equations using completing square method



RESEARCH METHODOLOGY

The research designs used for the study was survey research designs. This design involved the collection of data with a short span of time from randomly selected sample of the target population. The cross-sectional survey design also called parallel-sample design was used for the study.

Population

The population of the study comprised all senior secondary school three (SS3) students in public senior secondary schools in Nasarawa State.

Sample and Sampling Procedure

One senatorial district was randomly selected for the survey. Multi-stratified random sampling procedure was used to select the schools for the study in terms of gender, school location and background

Method of Data Collection; Instrumentation

Data were collected using, Quadratic Equation Diagnostic Test.

Quadratic Equation Diagnostic Test (QEDT):

The researcher selected the items of this test from past SSCE questions papers and work examples from text books that are recommended by WAEC in the syllabus. This was attempted by all the students in the sampled schools. Test was administered and scripts were returned and marked. The scores recorded with respect to the Newman error analysis procedure stages and was tested.

Techniques for Data Analysis

The research questions were answered using means and standard deviation of scores for errors committed by SS3 students while the Hypotheses were tested using student independent t-test at $\alpha \leq 0.05$.

Results and Data Analysis

Research Question 2; What are the means and standard deviations of error committed by male and female SS3 students that solve quadratic equations using completing square method?

Table 1: Means and Standard Deviations of Error Committed by Male and Female Students that Solve Quadratic Equation Using Completing Square Method

Variables	Means	Standard Deviation	t-test
Male	1.612	0.209	0.095
Female	1.780	0.227	

Table 1 shows the means and standard deviations of male and female SS3 students that solve quadratic equation using completing square method. The mean scores for male students was 1.612 and standard deviation was 0.209. The mean scores for the female students was 1.780 and standard deviation was 0.227

Research Question 3; What are the means and standard deviations of error committed by urban and rural SS3 students that solve quadratic equations using completing square method?

Table 2: Means and Standard Deviations of Error Committed by Urban and Rural Students that Solve Quadratic Equation Using Completing Square Method

Variables	Means	Standard Deviation	t-test
Urban	1.600	1.191	0.020
Rural	1.704	0.174	

Table 2 shows the means and standard deviations of urban and rural SS3 students that solve quadratic equation using completing square method. The mean scores for urban students was 1.600 and standard deviation was 1.191. The mean scores for the rural students was 1.704 and standard deviation was 0.174.

Research Question 3; What are the means and standard deviations of error committed by science and art SS3 students that solve quadratic equations using completing square method?

Table 3: Means and Standard Deviations of Error Committed by Science and Art Students that Solve Quadratic Equation Using Completing Square Method

Variables	Means	Standard Deviation	t-test
-----------	-------	--------------------	--------



Science	1.640	0.244	0.898
Art	1.648	0.182	

Table3: shows the means and standard deviations of science and art SS3 students that solve quadratic equation using completing square method. The mean scores for urban students was 1.640 and standard deviation was 0.244. The mean scores for the rural students was 1.648 and standard deviation was 0.482.

Hypothesis1: There is no significant difference in the means score of errors committed by male and female SS3 students that solved quadratic equations by completing square.

Table1, presents the t-test analysis of errors committed by male and female SS3 students that solved quadratic equation by factorization methods. The t-test for difference of two means was 0.095. Therefore, as $P = 0.095$ is greater than $\alpha = 0.05$ ($P = 0.095 > \alpha = 0.05$). The difference was not significant at $\alpha < 0.05$ therefore we do not reject the null hypothesis.

Hypothesis 2 There is no significant difference in the mean scores of errors committed by urban and rural SS3 students when solving quadratic equation by completing square.

Table2 presents the t-test result of errors committed by urban and rural SS3 students that solve quadratic equation by completing square method. The t-test difference of two mean was 0.020. It is observed that $P = 0.020$ is greater than $\alpha = 0.05$ (since $P = 0.020 > \alpha = 0.05$). The difference between the means of error that urban and rural SS3 students committed when solving quadratic, equation by completing square is not significantly different at $\alpha < 0.05$ therefore we reject the hypothesis.

Hypothesis 3

There is no significant difference in the mean scores of errors committed by science and arts SS3 students when solving quadratic equation by completing square, Table 3 presents t-test analysis of errors committed by science and arts SS3 students that solve quadratic

equation by completing square method. The t-test for difference of two means was 0.898. It is observed that $P = 0.898$ is greater than $\alpha = 0.05$ ($P = 0.898 > \alpha 0.05$). The difference between the means error that science and arts SS3 students committed when solving quadratic equation by completing square is not significantly different $\alpha < 0.05$. we therefore accept the hypothesis so stated.

DISCUSSION OF FINDINGS

The discussion was made on the bases of the research questions and the corresponding hypotheses stated and tested. The types of errors committed by students when solving quadratic equation using completing square by Newman Model reflects all the error types enumerated in the model. The most error type that the SS3 students committed was in the translation stage followed by the process skill, decoding, encoding and the comprehension stages. The difference between the errors type committed are however closely related. The presentation is in agreement with the findings of Effidini&siti (2010), Teoh (2010), and Nande (2013) that shows significant errors appearing at the transformation stage and the process skill the most. The result in the case of male and female table 1 shows that there were errors committed by both male and female students this agrees with previous researches (Bosire, Mondon&Barmoa 2008), who reported that irrespective of the schools, male respondent perform better than female. In regards to table 2, the mean score of errors committed by urban students when solving quadratic equation using completing square method was less than that of the rural students. This means the urban students committed less error than the rural students. The t-test was 0.020 which is greater than $\alpha \leq 0.05$, since $P = 0.020 > 0.05$, the hypothesis was rejected for the method of completing square. The findings here supported the finding in (Teoh,2010 and Shio, 2012). Even though the errors were more in different locations that is the rural pupils' errors were found mostly at comprehension and transformation stages while the urban students' errors were more at the process skill. However, in all, the rural students committed more errors than the urban students. Table3 shows that the mean score of errors committed by science students when solving quadratic equation by completing



square was less than that of the Arts students. This shows that science students committed less errors when solving quadratic equation by completing square. The t-test was 0.898, this is greater than $\alpha \leq 0.05$. Therefore, since $P = 0.898, \geq \alpha = 0.05$, the hypothesis was not accepted, indicating that the mean are not significantly different in completing square method. This did not support Trance (2013), that science and engineering students achieve better in mathematics than other discipline

CONCLUSION

The results of the findings showed that all the SS3 students presented difficulties at all stages of the Newman Model of Decoding, Comprehension, Transformation, Process skill and Encoding. That there is no significant difference in the means of SS3 students that solved quadratic equation by completing square gender, location and background. However, the means of urban and rural SS3 students that solve quadratic equation by completing square method are significantly different.

REFERENCES

- Abubakar, R. B. & Oguguo, O. D, (2011). Age and Gender as predictors of Academic Achievement of College Mathematics and Science students. instructional conference on teaching, learning and change. *Institution Association for teaching and learning IATEL*.
- Adeleke, M. A. (2007). Gender disparity in mathematical performance revisited: can training in problem solving bring difference between boys and girls? *Essays in Education, 21*.
- Adeyinka, A. A, & Kaino, L. M. (2014). School Type, Parental Influence and Mathematics Attitudes-Achievement Relationship: *A Quantile Analysis. vol.1(2) p.23-28*
- Airasian, P. W. & Walsh, M. E. (1997). Constructivism cautions. *KAPPAN. 78 (6), 444 - 449*.

- Allan L. W. (2009). Diagnostic and Pedagogical Issues with mathematical word problems. *Brunei International Journal of Science and mathematics Education* 1 (1), 100 – 112.
- Askew, M. (2003). Word problems: Cinderellas or wicked witches? In I. Thompson (Ed), *Enhancing primary mathematics teaching* (pp. 78 – 85). Berkshire, England: Open University Press.
- Bosire, J., Mondoh, H., & Barmao, A. (2008). Effect of streaming by gender on students achievement in mathematics in secondary schools in Kenya. *South African Journal of Education* Volume 28:595-607.
- Brown, J. S. & VanLehn, K. (1980). Repair theory: A generative theory of bugs in procedural skills. *Cognitive Science*, 4, 379-426.
- Chung, I. (2004): A comparative assessment of constructivist and traditionalist approaches to establishing mathematical connections in learning multiplication education, *Mathematics Educational* 125 (2) 271 – 278.
- Clarkson, P. C. & Campus, M. (1991), In Prakitipon, N. & Nakamura, S. (2006). Analysis of Mathematics Performance of Grade 5 Students in Thailand using Newman Procedure. *Journal of International Cooperation in Education* 9(1), pp. 111-122.
- Cortes' A., Kavafian, N. (1999). Les Principes Qui guideint La Pensee dans La Resolution des Equations. Petit X, Universite Joseph Fourier, Grenoble V. 51, pp. 47 – 73.
- Countryman, J. (1992). *Writing to Learn Mathematics*. Portsmouth, N.H.: Heinemann.
- Drapper, R. (2002). School Mathematics reforms, constructivism, and Literacy: A Case for literacy instruction in the reform-oriented math classroom *Journal of adolescent & adult literacy*, 45 (6) 520-534.
- Duong, H.T. (2017). An Investigation of Errors Related to solving problems on percentages. *The International Journal of Engineering and Science (IJES)* Vol. 6, Issue 3 pg 5 – 9.
- Effendi, Z. & Siti M .M. (2010). Analysis of students error in learning of quadratic equations. *International education studies*, vol. 3. No. 3 105 – 110.



- Eniayeju P. A & Jibrin A.T. (2012). Issues in the Nigerian science and technology education Agenda: *Contemporary Issue in Education*.vol.1. p.87-101.
- Elsa, E. & Richard, C. (2011). Procedural instructions, principles, and examples: How to structure instructions for procedural tasks to enhance performance, learning, and transfer. *Human Factors and Economics Society*.vol. 53 no. 6 pp.749-770.
- Fosnot, C. T., and Dolk, M. (2001). *Young Mathematicians at Work: constructing the number system, addition and subtraction*. Portsmouth, NH: Heinemann press.
- Gray, E. and Tall D. O. (2001). Relationship between embodied objects and symbolic precepts: an explanatory theory of success and failure in mathematics. *In Proceeding, 25th Conference of the Int. group for the psychology of mathematics education*.Dorderch, V. 12, pp 317 – 326.
- Inch, S. (2002). *The accidental constructivist; a mathematician's Discovery College teaching*, 50(3) 111 – 114.
- Koay, P.L., Chang, S.H. & Ghani, M. (2012). *Mathematics Content Knowledge of Low Attainers*. In Kaur, B. & Ghani, M. (EDs), *Low Attainers in Primary Mathematics* Singapore: World Scientist press Pp 159 – 176.
- Kulbir S. S. (2006). *The Teaching of Mathematics*; sterling publishers Ltd. New Delhi.
- Larochelle, M., Bednarz, N. (1998). *Constructivism and Education*, Cambridge, Ny: Cambridge University Press.
- Lee, T. Y. (2001). Problem solving in calculus (Unpublished postgraduate diploma dissertation, Nanyang Technological University, Singapore).
- Lester, F.K. (1994). Musings about mathematics problem-solving research: 1970-1994. *Journal for Research in Mathematics Education*, 25(6), 660-675. Lester, F. K., & Kehle, P. E. (2003). *From Problem Solving to Modeling: The evolution of thinking about research on complex mathematical activity*. In R. Leash, and H. Doer (Eds.) *Beyond constructivism: Models and modeling*

- perspectives on mathematics problem solving, learning and teaching (pp. 501-507). Mahwah, N.J.: Lawrence Erlbaum Associates, Publishers.
- Li, X. (2006). Cognitive Analysis of Students Errors in and Misconceptions in Variables, and Functions. A Dissertation Submitted to the Office of Graduate Studies of Texas A&M University.
- Lima, R .N. de. (2007). Equações algébricas no ensino médio: *Uma jornada por diferentes mundos da matemática*. Thesis, (Ph.D in mathematics education – pontifícia universidade católica de São Paulo), Sao Paulo.
- Lima, R. N. de & Tall, D. O. (2008). Procedural embodiment and magic in linear equations. *Educational Studies in Mathematics*, 67(1), 3-18.
- Lu, O.C. (2015). Error Analysis for Arithmetic word problems. A case study of primary three students in one Singapore School. National Institute of Education, Singapore. Wanyang Walk, Singapore 637616.
- Marinas, B., & Clements, M.A. (1990). Understanding the problem: A prerequisite to problem solving in mathematics. *Journal of Science and Mathematics Education in South East Asia*, 13 (10), 14-20.
- Mewman, M. A. (1983). *Strategies for Diagnosis and Remediation*. Sydney; Harcourt, Brace Jovanovich.
- Mu'awiya, H.U. & Muhammad, M.H. (2017). Analysis of student errors in learning of trigonometry among senior secondary school students in Zaria metropolis, Nigeria *IOSR Journal of Mathematics Vol. 13(2) pg 1 – 04*.
- Mu'awiya, H.U. (2015). Analysis of problem-solving difficulties with quadratic equation among senior secondary schools students in Zaria, Nigeria. *ATBU Journal of Science, Technology and Education Vol.3 (3) pg 1 – 10*.
- Musa D.C. (2014). Effect of laboratory Approach on junior secondary school students, achievement, interest and Retention in Mathematics in Keffi Education Zone, Nasarawa State. A Ph.D



Thesis submitted to school of post graduate studies University of Keffi.

Natcha, P., & Satoshi N. (2006). Analysis of mathematics performance of grade five students in Thailand using Newman procedure. CICE Hiroshima University, *Journal of International Cooperation in Education* VOL. 9, No 1, pp. 111-122.

Newman, M. A. (1977). An analysis of sixth-grade pupils' error on written mathematical task. *Victorian Institute for Educational Research Bulletin*, 39, 31-43.

Noraşiah, A. (2002). Diagnosis jenis kesilapan dalam hierarki Pembelajaran. [Error type diagnosis in learning simultaneous equation]. *Master of Education Research Project*. Universiti Kebangsaan Malaysia.

Norman, D.A. (1981). Categorization of action slips. *Psychological Review*, 88, 1-15.

Nzewi, U. N. (2003). *Gender Issues in Science and Technology Education for Sustainable U.B.E*. Federal College of Education Umunze Publication 232 – 238.

Ođili, G. A. (2006) *Mathematics in Nigeria secondary schools; A teaching perspective*. Anachuna Educational Books. Ikeja, Lagos.

Okeke, E. A. C. (2001). *Women in science, technology and mathematics education in Nigeria 42nd Annual Conference proceedings of STAN*. Ibadan HEBN.

Okeke, E., Okwo, F. and Oreh, C. (1996). Enrolment trend and drop-out of boys in Nigeria (1993 – 96). UNICEF Commissioned Country Study.

Osafehinti, I. O. (1990). The university of mathematics: *Journal of Mathematical Association of Nigeria* ABACUS 20(1) Pp 48 – 56.

Owolabi J. & Adejoke E.O. (2014). Effect of Gender, Age and Mathematics Anxiety on College Students Achievement in Algebra *American Journal of Education Research*, Vol. 2, No. 7: 474 – 476.

- Ozlem, Y. and Rossi, H. (2002). Constructivist teaching as an effective learning approach. *Undergraduate Research Journal for the Human Science Volume 7*.
- Payne, S. J. & Squibb, H.R. (1990). Algebra mal-rules and cognitive account of errors in cognitive science, Austin volume 14. Pp. 445 – 448.
- Polya, G. (1973). *How to solve it: A new aspect of mathematical method*. Princeton, N.J. Princeton University Press.
- Riccomini, P.J. (2005). Identification and remediation of systematic errors patterns in subtraction. *Learning disability quarterly, 28(3), 233-242*.
- Richardson, V. (1997). Constructivist teaching and teacher education; Theory and practice. In V.Richardson (ed), *constructivist Teacher educational; Building New understandings* (pp. 3 – 14). Washington, D.C. Falmer press.
- Sello, M. (2013). Errors and Misconceptions in Solving Quadratic Equations by Completing Square. *Mathematics Education*. Limpopo South Africa.
- Shio, K. J. (2012). Mathematics performance of primary school students in Assam (India); An Analysis using Newman Procedure. *International Journal of Computer Application in Engineering Science vol.2(1) pp. 17-21*.
- Siegle, R. S. (2003). *Implantation of Cognitive Science Research for Mathematics Education*. Carenegiamellon University, in Kilpatrick.
- Silver, E. A. (1986). *Using Conceptual and Procedural Knowledge: A focus on relationship in X*. LI (2006). *Cognitive Analysis of Students Errors and Misconception in Variables, Equations, and Functions*. A Dissertation Submitted to the Office of Graduate Studies of Texas A&M University.
- Sorensen, A. (2003). *Effective Teaching of High School Mathematics*. Singapore press.
- Stein, M., Silbert, J. & Carnine, D. (1997). *Designing effective mathematics instruction: a direct instructional approach (3rd ed)*, Columbus off: Merrill.



- Tall, D. O. (2004). *Thinking through three worlds of mathematics*. In :Proceeding 28th Conference of the International Group for the Psychology of Mathematics Education vol.4 pp.281-288. Bergen, Norway; PME
- Teoh, S. A. (2010). *The Newman Procedure for Analysing Primary four Pupil Errors on Written Mathematics Tasks: A Malaysian Perspective* International Conference on Mathematics Education Research 2010. Vol.8 pp. 264-271.
- Tong D.H. & Loc, N.P. (2017). Students errors in solving mathematical word problems and their ability in identifying errors in wrong solutions. *European Journal of Education Studies Vol. 3 (6) pg 226 - 241.*
- Trance, N. J. C (2013), process inquiry: Analysis of oral problem-solving skill in mathematics of engineering students. *US-China Education Review A*, ISSN 2161 – 623 X Vol. 3 No. 2 73 – 82.
- VanLehn, K. (1990). *Mind Bugs*. Cambridge, MA: MIT Press.
- Vlassis, J. (2002). *The balance Model: hindrance or support for the solving of linear equations with one unknown*. *Educational studies in mathematics* The Netherlands: Kluwer Academic Publishers volume, 49, pp 341 – 359.



REGULATORY FRAMEWORK AND POLITICAL PARTY FINANCING IN NIGERIA; ANALYZING 2011-2019 APC AND PDP PARTICIPATION IN GENERAL ELECTIONS

¹Haruna Musa Yakubu & ²Ibrahim Musa Ibrahim Kirfi

¹Faculty of Management Sciences; Federal University of Kashere, Nigeria, ²Corporate Affairs Commission of Nigeria

ABSTRACT

This paper examines the regulatory framework on political party financing in Nigeria. There is an ongoing debate on the theme that excessive illicit financing of political parties and massively corrupt financial support of individual candidates on electoral competitions constitute serious threat to the process, and negatively influences the development of politics and consolidation of democracy in developing countries. The study is restricted to political party financing and consolidation of democracy in Nigeria within the period of 2011 to 2019 in two major political parties in Nigeria- All Progressive Congress (APC) and Peoples Democratic Party (PDP). The primary sources of financing political parties in any democracy across the globe is through payment of membership dues, but none the less, Nigeria presents an exception because such dues are hardly paid, another source of funding for the political parties are government grants to political parties which is a universal practice. Party financing is the lifeline of political parties that further enables political parties to create awareness about party manifestoes as a means for mobilization and recruitment of more members, this is key to winning elections and execution of party programs through government policies.

INTRODUCTION

Democracy is a capital-intensive venture, and political parties cannot thrive effectively in the arena without sufficient funds. Cole (2016) notes that Nigeria practices one of the most expensive political systems in the world, Finance has been the major bane in the development of the country's political system, as there is no effective laws, or culture, or strong institutional regulatory framework about how to finance political parties or the limit of expenses on elections, and sources of such finances. There is an ongoing debate on the theme that excessive illicit financing of political parties and massively corrupt financial support of individual candidates on electoral competitions constitute serious threat to the process, and negatively influences the development of politics and consolidation of democracy in developing countries. Financial involvement in obtaining political nomination forms for elective public offices is astronomically higher and beyond the reach of average political aspirant. This high bid system of financing is a systemic instrument being used to ward-off financially weak-based politicians. Sourcing money for political party business beyond the approved limit has derailed politics and weakened the course of democracy (Stephen, 2003).

This paper, as a primary objective, intends to examine the regulatory framework on political party financing in Nigeria hence the need for a corresponding research question thus: Is there regulatory framework on political party financing in Nigeria? In an attempt to do justice to the foregoing objective and research question, this study is restricted to political party financing and consolidation of democracy in Nigeria within the period of 2011 to 2019 in two major political parties in Nigeria-

All Progressive Congress (APC) and Peoples Democratic Party (PDP). On the same basis, relevant literature will be reviewed to identify the knowledge gap with a view to filling in same.

LITERATURE REVIEW

This segment reviews relevant literature drawing its intellectual strength from the work of others with the aim of critically commenting on them in the light of conventional academic parameters.

Concept of Party Financing

The term “Political Finance” has been defined by Ojo (2000), Obiorah (2004), Pinto-Duschinsky (2001 and 2004), Emelonge (2004) and (Ayoade) as the use of money or the use of other material resources for political activities. It also embodies the sources or means through which political activities are sponsored in a given polity. The concept of political finance has two broad connotations viz money used for electioneering (campaign funds) and money used for political party expenses (party funds). Though there are other forms of political finance but these two will form the basis of our discussion because they constitute the foundation of every political activity. This broad definition of political finance while capturing the essence of the term does not acknowledge the multiplicity of forms and ways in which the monetization of politics may be used to influence political outcomes. The definition offered by Pinto – Duschinsky (2001) also fails to capture the centrality of “political”. That is, it shies away from explicating the ambits of the term “political”. According to Emelonge (2004:34), what the present author advocates here is not a semantic description but rather a clarification as to construction of the term when it comes to foreign contributions. For example, in issued, the definition of “political” is narrowed soon that foreign payments for technical assistance” and training are permitted. But such terms may be guises for more partisan contributions with political undertones or motives such as support for private governments’ business forms and convert propaganda). Pinto-Duschinsky (2004) modified his earlier thesis by positing that political finance is “money for electioneering”. Since political parties play a critical part in election campaigns in many parts of the globe, and since it is difficult to draw a distinct line between campaign costs of party organizations and their routine expenses, party funds may reasonably be considered “political finance”, too. He goes on to argue that party funding includes not only campaign expenses but also the costs of maintaining permanent offices, carrying out policy research, and engaging in political education, voter’s registration, and other regular functions of parties.

Therefore, a definition of political finance should include the under listed aspect which Pinto-Duschinsky (2004) subsequently identified in his contribution:

1. That political finance is a feature of non-democratic, as well as democratic regimes
2. The expenditure on elections and parties is only a part of a more far reaching issue. Political funding can be for activities ranging from lobbying, propaganda, support of interest groups to blatant bribery and
3. That the regulation of political finance is hindered by a plurality of avenues of obtaining and using money for political ends.



The Electoral Acts (2002, 2006 and 2010) contain numerous provisions in relation to political party and election finance. The Electoral Act (2002) defines election expenses in section 84 (1) as follows: “expenses incurred by a political party within the period from the date notice is given by the commission to conduct election up to and including the polling day in respect of the particular election. This definition is flawed totally because experience has shown that in Nigeria most election expenses are incurred by the candidates themselves and not the political parties. This definition is restrictive automatically excludes the election expenses incurred by candidates from whatever limitations on election expenses.

The Electoral Act (2006) has introduced ceilings on contributions by individuals to political parties and on the campaign expenses by political parties and candidates alike. Section 93 stipulates that election expenses by every candidate shall not exceed:

1. N500 million for presidential candidates
2. N 100 million for Governorship
3. N 20 million for Senate
4. N 10 million for House of representatives
5. N 5 million for State Assembly
6. N 5 million for Chairmanship of Local Government council and
7. N 500, 000 for Councillorship.

In addition, no individual shall donate more than N1 million to any candidate. Notation of this provision attracts fines ranging from N100,000 or one (1) month imprisonment or both for councillorship candidates, to N1 million or 12 months imprisonment or both for presidential candidates, while any individual who donates more than N1 million to any candidate is liable to a fine of N500, 000 or 9 months imprisonment or both. The electoral commission is left to fix the maximum donation any person can make to a political party (section 92) as opposed to a candidate who is stipulated in section 93. No party can accept or keep anonymous contributions of more than N100, 000 unless it can identify the source of the money and must keep records of all donations over N1 million.

The under listed puzzles come up for the Independent National Electoral Commission for consideration:

1. Has INEC undertaken an examination and audit of the accounts of the political parties?
2. Did the Commission place any limit on the amount of contribution which individuals or cooperate agencies made to political parties in the course of fund raising for the 2003, 2007 and 2011 elections?
3. Do all political parties have records of all contributions to their campaign funds?
4. Does INEC have a record, which shows the total expenses of all the political parties for the purposes of invoking the provisions of section 84, 92 and 93 sub sections (2), (3) and (6) of the 2004, 2006 and 2010 Electoral Acts?
5. What steps have been taken to sanction corporate bodies that contributed to the campaign funds of political parties in total disregard of the provisions of section 38 (2) of the company and

Allied matters Act (1990), which prohibits donations or gifts of any of its property or funds to a political party or association.

At present, only INEC can attempt the above questions. For the purpose of this paper the term ‘political finance’ refers to the deployment of financial and material resources by both political parties and politicians as prescribed by law of the polity to cover political expenses. The Draft Campaign Financing Bill, 2011 (“the Draft Bill”) of Kenya, which is currently undergoing a stakeholder review process by the Constitutional Implementation Committee of Kenya is a welcome initiative that will foster greater transparency and accountability in the financing of election and referendum campaigns. However, a number of shortcomings in the Draft Bill like those of Nigeria jeopardize these objectives, and a series of amendments are required before the Draft Bill complies with international standards on freedom of expression and information. The Campaign Financing Bill, 2011 sets out major reforms for funding of election campaigns, use of campaign funds in the nomination process, election campaign and elections. It will provide for the management, spending and accountability of funds during election and referendum campaign. It is important that the draft bill is clear on the concept of campaign financing to prevent any political and administrative frustration and even litigation in Court. CMD-Kenya believes that campaign financing refers to the manner in which political parties and individual candidates who seek to get elected to political office gather, utilize, and recover funds for electoral campaigns and in the case of political parties seek to maintain themselves as organizations. In this context the scope of the legislation should cover all aspects of campaign financing. We believe that the conceptual framework needs to be reflected in the interpretation to give the legislation effective statutory interpretation (CMD-Kenya, 2011).

In the analysis, ARTICLE 19 (2012) emphasizes that transparency in campaign financing is indispensable for embedding accountability and integral to the promotion of good governance and democracy. Only with full access to information can the media scrutinize the conduct of election candidates and inform public debate on the dynamics and distribution of political and economic power in Kenya. The engagement that transparency fosters between candidates for public office and the electorate also maximizes enjoyment of the right to political participation. The analysis finds that positive measures in the Draft Bill include the establishment of limits on political campaign expenditures, caps on the amount individuals can donate to candidates, and the imposition of a ban on anonymous donations. The establishment of a framework for the collection and reporting of data to a new Oversight Committee is a significant step towards furthering a culture of accountability in the financing of political campaigns.

However, ARTICLE 19 (2012) also finds that various elements of the Draft Bill fall short of international standards on freedom of expression and access to information. The Draft Bill designates as confidential all campaign financing information submitted to the oversight Committee, with only limited disclosure exceptions for information that is the subject of a complaint or investigation. This runs counter to the principles of proactive and maximum disclosure that are central to the right of access to information. The selection criteria for the Oversight Committee are also left ambiguous, and there are inadequate safeguards to ensure the accountability of this committee to the public. In



conclusion, ARTICLE 19 (2012) urges the Kenyan legislature to revise the Draft Bill and adopt it only after it is brought into compliance with international standards on freedom of expression and information. The need for greater transparency in all aspects of public life in Kenya further demonstrates the urgent need for a comprehensive access to information framework to be implemented in the country.

Political Party Financing and Consolidation of Democracy in Nigeria

Financing political party for its functions and sponsoring election campaigns is vital in a vibrant democracy. Ballington et.al (2014) note that regular elections organized between competing political parties is the dominant method of selecting democratic governments. For political parties and their nominees to reach out to the teeming electorates to sell the parties manifestoes, it becomes imperative to have access to enough money so as to off-set election expenses. Election expenses, according to Electoral Act (2010) means “expenses incurred by a political party within the period from the date notice is given by the Commission to conduct an election up to and including the polling day in respect of the particular election”. Magolowondo et al (2012) note that parties may win or lose elections well before they are held simply on account of their resource endowment or lack thereof. In other instances, how parties’ practice or fail to practice intra-party democracy has to some extent been influenced by the way they are financed and how these resources are allocated within the different parties. The concern for possible negative impact of money on politics and governance warranted the incorporation of the regulatory clause in the 1999 Constitution and the 2010 Electoral Act of the Federal Republic of Nigeria to curb the excesses and unregulated donations to political parties and individual candidates which breeds corruption. Money exercises undue influence on politics, and undermines the integrity of elections, credibility and legitimacy of government. In the first republic (1960-1966), there was indefinite electoral law on campaign finance.

Funding election activities and other political parties’ functions were the responsibility of the individual parties and their candidates. From knowledge of hindsight, there were political parties who were accused to have used the state funds and investments to sponsor party activities and campaigns, such as the National Council of Nigeria Citizens (NCNC) and Action Group (AG). The 1979 Constitution of the second republic (1979-1983) provided regulatory law on campaign finance which prohibited associations, other than political parties, from campaigning on behalf of a candidate or contributing funds to parties and election expenses of candidates. There was the budgetary provision for annual grants to political parties; and political parties were empowered to receive donations from individuals and corporate bodies, but it prohibited donations from external bodies. The unquantifiable party-donations from individuals and corporate bodies, and unprecedented expenses incurred on party activities and campaigns due to the fact that the limit of funds political parties and aspirants could raise from individuals and corporate bodies was not specified by law. The prevalent corrupt practices, electoral irregularities, and uncordial interparty relations in the second republic amongst the National Party of Nigeria, Nigerian Peoples Party, Unity party of Nigeria, Great Nigerian Peoples Party, People Redemption Party, etc. breached the provisions of subsisting Constitution and exacerbated party expenses. Political party antagonistic clashes, south-western zone post-election crisis, and increasing tension in the heated polity abruptly brought the republic to tragic end through military coup d’état.

Government in the fourth republic is not oblivious of the fact that politicians would abuse party financing if their activities are unregulated and unsupervised by electoral umpire. On the strength of the perceived dangerous threat to democracy, Section 221 of the 1999 Constitution of the Federal Republic of Nigeria provides that “no association, other than a political party, shall canvass for votes for any candidate at any election or contribute to the funds of any political party or to the election expenses of any candidate at any election”. Section 225(2) stipulates that “every political party shall submit to the Independent National Electoral Commission (INEC) a detailed annual statement and analysis of its sources of funds and other assets together with a similar statement of its expenditure in such form as the Commission may require”. 225(3) states that “no political party shall hold or possess any funds or other assets outside Nigeria; or be entitled to retain any funds or assets remitted or sent to it from outside Nigeria”. Similarly, Section 225(4) provides that “any funds or other assets remitted or sent to a political party from outside Nigeria shall be paid over or transferred to the Commission within twenty-one days of its receipt with such information as the Commission may require”; while 225(5) stipulates that “the Commission shall have power to give directions to political parties regarding the books or records of financial transactions which they shall keep and, to examine all such books and records” (FRN, 1999).

METHODOLOGY

The study utilizes both primary and secondary methods of data collection. The secondary were gathered through library research and the internet. The materials consisted of books, journals, articles, reports, periodicals, monographs, newspapers and magazines. Information gotten shall be used to evaluate how political party financing affects consolidation of democracy and what needs to be done to regulate political party financing. The primary method includes questionnaire which shall be administered purposively to respondents.

Analysis and presentation of data followed the path of statistical package for social science (SPSS) method of data analysis. This summarizes data, creates appropriate tables and examines relationships among variables. Thus, data for this investigation will be analyzed using simple percentile, descriptive statistical technique, and the results are further described using tables.

The simple percentage formula to be used is:

$$\frac{NR}{TNR} \times 100$$

Where NR= the number of responses to each questionnaire,

TNR= is the total number of responses. This tool of analysis enables the researcher assess weights of opinion to a questionnaire and the percentage allocated to that weight of opinion. Ethically, in order to conform to the standards of conduct involved in the research, a permission to carry out the study was granted in the department, starting with the approval of the topic. Written consent was obtained from the respondents and were assured of confidentiality. (See Appendix 1)

The Sources and Legal Frameworks for Funding of Political Parties in Nigeria.



The sources of funding political parties in Nigeria between the Second, Third and the Fourth Republics were:

1. Statutory allocation
2. Fees and subscription and
3. Lawful donations and public collection respectively.

A number of constitutional provisions and legislative enactments relate to political finance. The Constitution of Nigeria provides the basic framework for the implementation and enactment of other laws in the polity. The supremacy of the constitution is further emphasized in section 1 (3), which provides “if any other law is inconsistent with the provisions of this constitution, this constitution shall prevail, and that other law shall to the extent of the inconsistency be void” (The Constitution, 1999:1).

In other words, every other law in the country must be in line with the provisions of the constitution. It also follows that any inadequacy in the constitution will automatically taint the provisions of subsequent laws in the same subject matter. The 1999 constitution in section 221 prohibits any association other than political parties from making political donations. The constitution in section 225 provides as follows:

1. Every political party shall, at such times and in such manner as the Independent National Electoral Commission may require, submit to the Independent National Electoral Commission a statement of its assets and liabilities.
2. Every political party shall submit to the Independent National Electoral Commission a detailed annual statement and analysis of its sources of funds and other assets together with similar statements of its expenditure in such form as the Commission may require.
3. No political party shall – (a) hold or possess any funds or other assets outside Nigeria; or (b) be entitled to retain any funds or other assets outside Nigeria
4. Any funds or other assets remitted or sent to a political party from outside Nigeria shall be paid over or transferred to the Commission within twenty-one days of its receipt with such information as the Commission may require.
5. The Commission shall have power to give directions to political parties regarding the books or records of financial transactions which they shall keep and, to examine the all such books and records.

The Commission was also empowered in subsection 6 of the above section to audit the account of political parties through its staff or professional auditors. The commission is further empowered by section 226 of the constitution to prepare and submit a report on the financial account of the political parties to the National Assembly and are authorized to have unlimited access to the records of the political parties. The National Assembly is empowered in section 228 of the 1999 constitution to make laws for the punishment of any individual or party who fails to observe the above provisions and the disbursement of annual grants to political parties.

The Electoral Act 2002

The provision of this law covers virtually every process of electoral activities in the country. Section 76 provides for the oversight function of the Electoral Commission over the activities of the political parties and also provides for a fine of N500, 000 for non-conformity by any individual to lawful directions by the Commission in carrying out its supervisory functions. Section 77 makes provision for a fine of N500, 000 for the contravention of section 225 (3) (a) and (b) of the 1999 Constitution relating to ownership of foreign asset by any political party and any donation from outside the country. Section 78 provides for period of time, which the annual account of a political party should cover. It also empowered the Commission to audit the account of political parties periodically. Section 79 makes provision for a separate finance statement for election expenses as prescribed in section 100 of the act not later than 90 days after the election. Surprisingly section 100 of the Electoral Act has no provision whatsoever that relates to party finances it rather talks about qualification of a person who can contest elections. Any political party that fails to submit the audited return of election expenses is guilty of an offense punishable on conviction with a fine of N100, 000. Section 80 makes provision for the disbursement of grants to political parties that are contesting elections. It provides that 30% of the grant shall be distributed equally among the political parties before the election and the remaining 70% shall be shared among the political parties after the result of the election has been known, in proportion to the number of seats won by each party in the National Assembly. Section 81 provides that the National Assembly may make an annual grant to political parties and 30% of such grants should be shared among the political parties in proportion to number of seats won by each party in the National Assembly. Section 82 provides as follows: No political party shall be eligible to receive a grant under section 93 unless it wins a minimum of 10 percent of the total votes cast in the local government election in at least two-thirds of the states of the federation. Section 93 which is referred to in the above provision has no such provisions. Section 83 empowers the Commission to place the limitation on the amount of money or other assets, which an individual or corporate body can contribute to a political party. Also, it stipulates for a record of all contributions.

Electoral Act 2006

Under the 2006 Electoral Act which was used in the conduct of the 2007 elections while the recommendations of the Uwais Panel were being debated, the National Assembly was empowered to approve a grant to be disbursed to political parties. The 2006 law also stipulates how the grant should be divided, 10 percent going to be shared equally among the registered political parties and the remaining 90 percent disbursed in proportion to the number of National Assembly seats won by each party. The law also gives INEC the power to place a limit on the amount of money or other assets an individual or group can contribute to a political party. For a presidential candidate the sum is N500 million, governor N100 million, senator N20 million and a representative N10 million. A state assembly candidate, or chairman N5 million and a local councillorship, N500,000. It is an open question whether this aspect of the electoral law has ever been paid attention to not to talk of being enforced. Some of the then 50 parties have not in any way justified the money they receive from government. It has been discovered that some of the parties only exist on the pages of newspapers and



magazines. They only function when elections are coming or when funding is released by government. They collect the funds, share and go home to rest till another round of funding is available. A few of the parties are even run by close-knit family members. So what does a party exist for if it is only to share government funds?

As the nation moved towards 2011 elections, it became imperative to revisit the issue of political financing in Nigeria. The Uwais Panel report recommended the continued funding of parties by government through INEC, but suggests a ceiling for individual donations for each category of office. These figures run from a limit of N20 million for individual donations for a presidential candidate to N15 million for a governor, N10 million for a senator, N3 million for a local government chairmanship candidate. It makes eminent sense for party members to fund their own organization. The Uwais panel recommends that only parties that score 2.5 percent of the votes in the 2011 elections should be eligible to receive funds from public grants, but this like many other issues were expunged in the 2010 Electoral Act.

Electoral Act 2010

The 2011 General Elections are over with local and international acclamation to the electoral commission. The elections were not flawless; however, Nigerians and foreign witnesses are unanimous that the just concluded polls were held in substantial compliance with the nation's electoral laws. It is too early to pre-empt the political parties on the veracity of the election expenses they will submit to INEC in the next 6 months. But then, is six months not too long? I should think three months after the polls is okay, more so as candidates, who spend the bulk of the campaign money, are not yet under obligation to submit election expenses report.

This post-election period, two major things must happen. The first is for the Independent National Electoral Commission (INEC) to rise up to its constitutional duty to enforce political finance provisions as contained in the statutes viz. the 1999 Constitution (as amended), the Electoral Act 2010 (as amended) as well as the Political Party Finance Manual and Handbook. The second matter of urgent national importance is the amendment of these laws to make them more enforceable. The current legal framework requested three reports from the political parties. The first, according to section 89 of the Electoral Act 2010, is the annual statement of assets and liabilities, analysis of their sources or funds and other assets as well as their statements of expenditure. INEC is mandated to publish the report in three national newspapers. The other report which is of greater interest to campaign finance experts is stated in section 92 of the current electoral act. Sub-section 3 of the clause says "Election expenses of a political party shall be submitted to the Commission in a separate audited return within 6 months after an election and such return shall be signed by the party's auditors and counter signed by the chairman of the party and be supported by a sworn affidavit by the signatories as to the correctness of its contents". Sub-section 5 states that the return shall show the amount of money expended by or on behalf of the party on election expenses, the items of expenditure and the commercial value of goods and services received for election purpose. Sub section 6 mandated the political parties to publish this report in at least two national newspapers. The third

report is requested of political parties in section 93 (4) and it states that "A political party sponsoring the election of a candidate shall within 3 months after the announcement of the results of the election, file a report of the contributions made by individuals and entities to the Commission". Hitherto, these provisions have been violated with impunity. If the truth will be told, the last general election in Nigeria was the most expensive in the annals of our electoral democracy. Given the resources deployed by some of the wealthy candidates during the elections, there is no gainsaying the fact that the contestants showed scant regards for the provision of section 91 subsections 2 – 5 of the Electoral Act 2010 which placed a cap on the amount of money they are to spend on their campaigns. Predominant among the issues at stake is that of godfatherism which poses a great threat to democratic consolidation in Nigeria.

Limitations on Nigeria's Election Expenses

The fourth republic has witnessed enactment of Electoral Acts and subsequent amendments by the National Assembly to guide conduct of elections since the return of democracy in 1999. The Electoral Act of 2002 guided 2003 elections; 2006 Act (as amended) was used for 2007 elections; and 2010 Act (as amended) guided 2011, 2015 and 2019 general elections. The 2006 Act categorically provided funds limitations on campaign expenses to curtail the unhealthy influence of money on party activities and electioneering campaigns. Hereunder illustrates the stipulations. Section 90(1) of the 2010 Electoral Act provides that "the Commission shall have power to place limitation on the amount of money or other assets, which individual or group of persons can contribute to a political party". In the same manner, Section 91(2)-(7) states that: the maximum election expenses to be incurred by a candidate at a Presidential election shall be one billion naira (N1,000,000,000.00); the maximum election expenses to be incurred by a candidate at a Governorship election shall be two hundred million naira (N200,000,000.00); the maximum amount of election expenses to be incurred in respect of Senatorial seat by a candidate at an election to the National Assembly shall be forty million naira (N40,000,000.00), while the seat for House of Representatives shall be ten million naira (N10,000,000.00); in the case of State Assembly election, the maximum amount of election expenses to be incurred shall be ten million naira (N10,000,000.00); in the case of Chairmanship election to an Area Council, the maximum amount of election expenses to be incurred shall be ten million naira (N10,000,000.00); in the case of Councillorship election to an Area Council, the maximum amount of election expenses to be incurred shall be one million naira (N1,000,000.00) (Electoral Act, 2010). Subsection 91(9) provides that "no individual or other entity shall donate more than one million (N1,000,000.00)" to either a political party or to a candidate. Subsection 91(10) states that a candidate who knowingly acts in contravention of this section commits an offence and on conviction shall be liable, in case of presidential election, to a maximum fine of N1,000,000.00 or imprisonment of 12 months or both; in the case of a governorship election, to a fine of N300,000.00 or imprisonment for 9 months or both; in the case of senatorial seat election in the National Assembly to a fine of N600,000.00 or imprisonment for 6 months or both; in the case of House of Representatives election in the National Assembly to a fine of N500,000.00 or imprisonment for 6 months or both; in the case of a State House of Assembly election to a fine of N300,000.00 or 3 months imprisonment or both; in the case of Chairmanship election to a fine of N300,000.00 or 3 months imprisonment or both; in the



case of Councillorship election to a fine of N100,000.00 or 1 month imprisonment or both (Electoral Act, 2010). The 2010 Act also made a provision in Section 93(1) that “no political party shall accept or keep in its possession any anonymous monetary or other contributions, gifts, properties, etc from any source whatsoever. For the purpose of this research, political party financing represents the means through which the political party receive funding to execute their day to day activities before, during and after elections. In our view, financing, a major component in the development of political parties and by extension democracy itself this is largely due to the fact that democracy can only flourish where there are strong and vibrant political parties and therefore vibrant and strong political parties can only be possible when they are well funded to carry out their primary mandate of education, mobilization, information dissemination, and recruitment.

In the same vein it is pertinent to note that every political association must fulfill certain conditions before it can be registered and recognized as a political party, one of which is the source of funding. The primary sources of financing political parties in any democracy across the globe is through payment of membership dues, but none the less, Nigeria presents an exception because such dues are hardly paid, another source of funding for the political parties are government grants to political parties which is a universal practice. Party financing is the livewire of political parties that further enables political parties to create awareness about party manifestoes as a means for mobilization and recruitment of more members, this is key to winning elections and execution of party programs through government policies.

REFERENCES

- Ayoade, J .A.A (2006) “*Godfather Politics in Nigeria*” in *Money, Politics and Corruption in Ballington*, J. et a
- I (2014). *Funding and political parties and election campaigns: a handbook on political finance*. International Institute for Democracy and Electoral Assistance, Sweden, Accessed from: <http://funding-of-political-parties-andelection-campaigns-a-handbook-on-political-PDF-pd>, August 30 2016.
- Ballington, J. et al (2014). *Funding and political parties and election campaigns: a handbook on political finance*. International Institute for Democracy and Electoral Assistance, Sweden, Accessed from: <http://funding-of-political-parties-and-electioncampaigns-a-handbook-on-political-PDF-pd> (August 30 2016).
- Cole, P., (2016). Nigeria: Financing political parties, elections and corruption, Accessed from <http://allafrica.com/stories/201603090833.html> (July 29 2016).
- Emelonye, U. (2004) “Political Finance in Nigeria: A Policy Agenda for Reform, in Ndubuisi Obiorah (ed) *Political Finance and Democracy in Nigeria: Prospects and Strategies for Reform*. Lagos: Center for Law and Social Action.
- Federal Republic of Nigeria (2002) *Electoral Act*: Abuja: Government Printers.
- Federal Republic of Nigeria (2004) *Electoral Act*: Abuja: Government Printers.
- Federal Republic of Nigeria (2006) *Electoral Act* Abuja: Government printers

- FRN (2010). Re-enactment of electoral act and Independent National Electoral Commission, to regulate the conduct of federal, state, and area council elections and for related matters. Abuja: Government Press, ch.6, pp.19-31. Ibid [4]
- Magolowondo, A., Falguera, E. and Matsimbe Z., (2012). Regulating political party financing: Some insights from the praxis. Netherland: Institute for Multiparty Democracy/ *International Institute for Democracy and Electoral Assistance* (A study).
- Obiorah N. (ed) *Political Finance and Democracy in Nigeria: Prospects and Strategies for Reform*. Lagos: Center for Law and Social Action.
- Ojo, Jide (2012) Recommendations for Political Finance Reforms in Nigeria, *IFES Political Finance Newsletter*, Volume 3, Issue 7, July
- Pinto-Duschinsky, M (2002) "Financing Politics: A Global View", *Journal of Democracy*, Vol. 3, Number 4 October. pp. 118 – 134.
- Stephen E (2008). The Okija Shrine: Life and Death in Nigerian Politics. *The Journal of African History* 49: 446-466.



THEORETICAL EVALUATION OF STEPS APPROACHING ZERO EMISSION ON A DOUBLE THICK BARRIER OF A GAMMA PARTICLE

¹E. W. Likita, ²M. A. Abdul Azeez, ²F. W. Burari and ²O. W. Olassoji

¹ Department of Physics, University of Maiduguri, Maiduguri, Borno State, Nigeria

² Department of Physics, Alubakar Tafawa Balewa University, Bauchi, Nigeria

Email: emmalikita2014@gmail.com

ABSTRACT

The goal of this work is to obtain tunneling probability of a gamma particle. The application of Schrödinger's equation in barrier penetration has been applied to gamma particle decay for light, medium and heavy nuclei. Gamma particle tunneling probability has been calculated analytically. Decay probability computed for each gamma particle emitting nucleus shows interesting variations. Log plot of calculated Decay constant plotted against atomic number (Z), mass number (A) and Energy for gamma particle emitting nucleus shows the variations interesting. Half-life which is a function of decay probability plotted against gamma particle energy or against atomic number of gamma particle emitting nucleus shows the variations of decay probabilities. Log plot of Calculated Half-life plotted against atomic number (Z), mass number (A) and Energy for gamma particle emitting nucleus shows interesting variations of decay probabilities. Calculated half-lives compared with experimental half-lives for each gamma particle emitting nucleus shows results which are in good agreement.

Key word: Schrödinger's equation, Emission, Half-life, Gamma and Decay constant.

INTRODUCTION

Gamma decay is a type of radioactive decay in which gamma rays are emitted.

Gamma decay occurs when a nuclide is produced in an excited state, gamma emission occurring by transition to a lower energy state. It can occur in association with alpha decay and beta decay (Raju et al., 2006). A gamma ray or gamma radiation (symbol γ), is a penetrating electromagnetic radiation arising from the radioactive decay of atomic nuclei. It consists of the shortest wavelength electromagnetic waves and so imparts the highest photon energy. Paul Villard, a French chemist and physicist, discovered gamma radiation in 1900 while studying radiation emitted by radium (Villard, 1900a). In 1903, Ernest Rutherford named this radiation gamma rays based on their relatively strong penetration of matter; he had previously discovered two less penetrating types of decay radiation, which he named alpha rays and beta rays in ascending order of penetrating power (Rutherford, 1903). Gamma rays from radioactive decay are in the energy range from a few kilo electron volts (keV) to approximately 8 Mega electron volts (~8 MeV), corresponding to the typical energy levels in nuclei with reasonably long lifetimes. The energy spectrum of gamma rays can be used to identify the decaying radionuclides using gamma spectroscopy. Very-high-energy gamma rays in the 100–1000 tera electron volt (TeV) range have been observed from sources such as the Cygnus X-3 micro quasar. Natural sources of gamma rays originating on Earth are mostly as a result of radioactive decay and secondary radiation from atmospheric interactions with cosmic ray particles (Villard, 1900b). However, there are other rare natural sources, such as terrestrial

gamma-ray flashes, which produce gamma rays from electron action upon the nucleus. Notable artificial sources of gamma rays include fission, such as that which occurs in nuclear reactors, and high energy physics experiments, such as neutral pion decay and nuclear fusion. Gamma rays and X-rays are both electromagnetic radiation, and since they overlap in the electromagnetic spectrum, the terminology varies between scientific disciplines. In some fields of physics, they are distinguished by their origin: Gamma rays are created by nuclear decay, while in the case of X-rays; the origin is outside the nucleus. In astrophysics, gamma rays are conventionally defined as having photon energies above 100 keV and are the subject of gamma ray astronomy, while radiation below 100 keV is classified as X-rays and is the subject of X-ray astronomy. This convention stems from the early man-made X-rays, which had energies only up to 100 keV, whereas many gamma rays could go to higher energies. A large fraction of astronomical gamma rays are screened by Earth's atmosphere.

MATERIALS AND METHOD

Materials

The materials used are the Schrödinger's equation.

Method

We now consider the beam of a particle incident upon a square potential barrier of height V_0 presumed positive for now and width a . As mentioned above, this geometry is particularly important as it includes the simplest example of scattering phenomenon in which a beam of particles is 'deflected' by a local potential. Moreover, this one-dimensional geometry also provides a flat form to explore a phenomenon peculiar to quantum mechanics quantum tunneling (Dyson, 1951).

The potential energy variation in the case of a rectangular potential barrier shown in figure 1 is given by

$$\begin{aligned}
 V(x) &= \left. \begin{array}{l} 0, \quad x < 0 \\ V_0, \quad 0 < x < L \end{array} \right\} \\
 V(x) &= \left. \begin{array}{l} 0, \quad x < 0 \\ V_0, \quad 0 < x < L \end{array} \right\} \\
 &(1)
 \end{aligned}$$

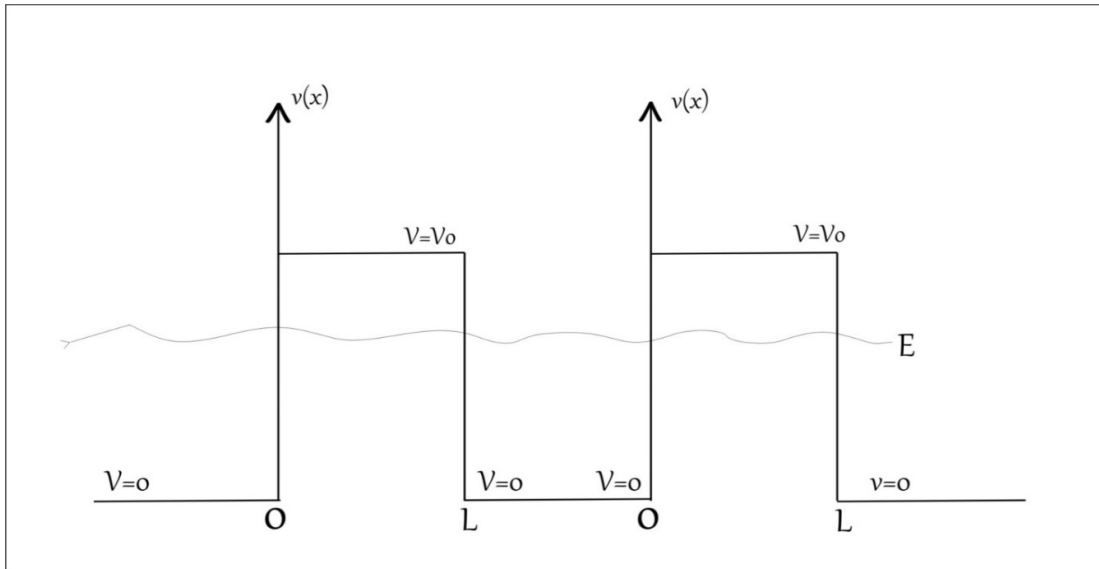

Fig.1: a rectangular double thick potential barrier of width L and height V_0 .

Let us consider two cases

- (i) $0 < E < V_0$ Classically a particle of energy E if incident from the left would be reflected at the double thick barriers as it cannot enter ($0 < x < L$) in which its K.E is negative. To describe the behavior of particle quantum mechanically, we will have to solve the Schrödinger equation,

$$\left(\frac{d^2 \varphi(x)}{dx^2} + \frac{2m}{\hbar^2} [E - V(x)] \varphi(x) \right) \left(\frac{d^2 \varphi(x)}{dx^2} + \frac{2m}{\hbar^2} [E - V(x)] \varphi(x) \right) = 0$$

Or

$$\left(\frac{d^2 \varphi(x)}{dx^2} + k^2 \varphi(x) \right) \left(\frac{d^2 \varphi(x)}{dx^2} + k^2 \varphi(x) \right) = 0, k^2 = \frac{2mE}{\hbar^2}, x < 0 \text{ and } x > L \quad (2)$$

And

$$\left(\frac{d^2 \varphi(x)}{dx^2} + \gamma^2 \varphi(x) \right) \left(\frac{d^2 \varphi(x)}{dx^2} + \gamma^2 \varphi(x) \right) = 0, \gamma^2 = \frac{2m(V_0 - E)}{\hbar^2}, 0 < x < L \quad (3)$$

The general solutions of these equations are given by

$$\varphi^2(x) = (A e^{ikx} + B e^{-ikx})(A e^{ikx} + B e^{-ikx}), x < 0 \quad (4)$$

$$\varphi^2(x) = (C e^{\alpha x} + D e^{-\alpha x})(C e^{\alpha x} + D e^{-\alpha x}), 0 < x < L \quad (5)$$

$$\varphi^2(x) = (F e^{ikx} + G e^{-ikx})(F e^{ikx} + G e^{-ikx}), x < L \quad (6)$$

Notice that we allow for waves traveling in both the directions for $x < 0$ representing the incident and reflected waves. We must also allow for $e^{\gamma x}$ and $e^{-\gamma x}$ term in the region $0 < x < L$ because x is finite and there is no danger of φ becoming infinite. We have only a wave traveling from left

to right of $x > L$ as there cannot be any wave travelling from right to left (reflected wave) since there is no discontinuity in the potential. Hence we must set $G=0$. The solution, therefore would be

$$\varphi^2(x) = (F e^{ikx})(F e^{ikx}), x > L \quad (7)$$

The continuity conditions (that is, φ and $d\varphi/dx$ be continuous) at $x = 0$ and at $x = L$ yield

$$\text{At } x = 0, A + B = C + D \text{ and } ik(A - B) = \alpha(C + D) \quad (8)$$

At $x > L$,

$$(Ce^{\gamma L} + De^{-\gamma L})(Ce^{\gamma L} + De^{-\gamma L}) = (F e^{ikL})^2 \text{ and } \gamma(Ce^{\gamma L} + De^{-\gamma L})\gamma(Ce^{\gamma L} + De^{-\gamma L}) = (ikF e^{ikL})^2 \quad (9)$$

There are number of ways of solving these equations. If solution leads to

$$\left. \begin{aligned} C^2 &= \left(\frac{[(\gamma+ik)A+(\gamma-ik)B]}{2\gamma} \right) \left(\frac{[(\gamma+ik)A+(\gamma-ik)B]}{2\gamma} \right) \\ D^2 &= \left(\frac{[(\gamma-ik)A+(\gamma+ik)B]}{2\gamma} \right) \left(\frac{[(\gamma-ik)A+(\gamma+ik)B]}{2\gamma} \right) \end{aligned} \right\} x = 0 \quad (10)$$

Similarly

$$\left. \begin{aligned} C^2 &= \left(\frac{[(\gamma+ik)Ae^{-(\gamma-ik)L}F]}{2\gamma} \right) \left(\frac{[(\gamma+ik)Ae^{-(\gamma-ik)L}F]}{2\gamma} \right) \\ D^2 &= \left(\frac{[(\gamma-ik)Ae^{(\gamma+ik)L}F]}{2\gamma} \right) \left(\frac{[(\gamma-ik)Ae^{(\gamma+ik)L}F]}{2\gamma} \right) \end{aligned} \right\} x = L \quad (11)$$

Equating the values of C^2 and D^2 to each other yield

$$((\gamma + ik)A + (\gamma - ik)B)^2 = ((\gamma + ik)Ae^{-(\gamma-ik)L}F)((\gamma + ik)Ae^{-(\gamma-ik)L}F) \quad (12)$$

And

$$((\gamma - ik)A + (\gamma + ik)B)^2 = ((\gamma - ik)Ae^{(\gamma+ik)L}F)((\gamma - ik)Ae^{(\gamma+ik)L}F) \quad (13)$$

And so

$$(B/A)^2 = \left(\frac{(\gamma-ik)}{(\gamma+ik)} [e^{(\gamma+ik)L} F/A - 1] \right) \left(\frac{(\gamma-ik)}{(\gamma+ik)} [e^{(\gamma+ik)L} F/A - 1] \right) \quad (14)$$

Putting the above value of $(B/A)^2$ in to (3.14) yields

$$\begin{aligned} &\left(\frac{(\gamma + ik) + (\gamma - ik)^2}{(\gamma + ik)} \left[e^{(\gamma+ik)L} \frac{F}{A} - 1 \right] \right)^2 \\ &= \left((\gamma + ik) e^{(\gamma+ik)L} \frac{F}{A} \right) \left((\gamma + ik) e^{(\gamma+ik)L} \frac{F}{A} \right) \end{aligned}$$

Or



$$\left(\frac{(\gamma + ik)^2 + (\gamma - ik)^2}{(\gamma + ik)} \left[e^{(\gamma+ik)L} \frac{F}{A} - 1 \right] \right)^2$$

$$= \left((\gamma + ik)^2 e^{(\gamma+ik)L} \frac{F}{A} \right) \left((\gamma + ik)^2 e^{(\gamma+ik)L} \frac{F}{A} \right)$$

O_2

$$((\gamma + ik)^2 - (\gamma - ik)^2)^2$$

$$= \left(\frac{F}{A} [(\gamma + ik)^2 e^{(\gamma+ik)L} - (\gamma - ik)^2 e^{(\gamma+ik)L}] \right) \left(\frac{F}{A} [(\gamma + ik)^2 e^{(\gamma+ik)L} - (\gamma - ik)^2 e^{(\gamma+ik)L}] \right)$$

$$\left(\frac{F}{A} \right)^2$$

$$= \left(\frac{4iky}{[(\gamma + ik)^2 e^{(\gamma+ik)L} - (\gamma - ik)^2 e^{(\gamma+ik)L}]} \right) \left(\frac{4iky}{[(\gamma + ik)^2 e^{(\gamma+ik)L} - (\gamma - ik)^2 e^{(\gamma+ik)L}]}\right)$$

After multiplying the numerator and denominator $e^{(\gamma-ik)L}$

$$\left(\frac{F}{A} \right)^2 = \left(\frac{4iky e^{(\gamma-ik)L}}{[(\gamma + ik)^2 - (\gamma - ik)^2 e^{2\gamma L}]}\right) \left(\frac{4iky e^{(\gamma-ik)L}}{[(\gamma + ik)^2 - (\gamma - ik)^2 e^{2\gamma L}]}\right)$$

$$= \left(\frac{4iky e^{(\gamma-ik)L}}{[(\gamma + ik)^2 - (\gamma - ik)^2 e^{2\gamma L}]}\right) \left(\frac{4iky e^{(\gamma-ik)L}}{[(\gamma + ik)^2 - (\gamma - ik)^2 e^{2\gamma L}]}\right)$$

$$= \left(\frac{4iky e^{(\gamma-ik)L}}{[(\gamma^2 - k^2)(1 - e^{2\gamma L}) + 2iky(1 + e^{2\gamma L})]}\right) \left(\frac{4iky e^{(\gamma-ik)L}}{[(\gamma^2 - k^2)(1 - e^{2\gamma L}) + 2iky(1 + e^{2\gamma L})]}\right) \quad (15)$$

Putting the value of $\left(\frac{F}{A} \right)^2$ from above into equation (5), we get

$$\left(\frac{F}{A} \right)^2 = \left(\frac{(\gamma^2 - k^2)(e^{2\gamma L} - 1)}{[(\gamma^2 - k^2)(1 - e^{2\gamma L}) + 2iky(1 + e^{2\gamma L})]}\right) \left(\frac{(\gamma^2 - k^2)(e^{2\gamma L} - 1)}{[(\gamma^2 - k^2)(1 - e^{2\gamma L}) + 2iky(1 + e^{2\gamma L})]}\right) \quad (16)$$

It may be mentioned here that in case one is interest in finding C/A and D/A , this can be achieved by substituting the value of $\left(\frac{F}{A} \right)^2$ from (15) into equations (11).

From (7), the reflection coefficient (or the probability of reflection) is given by

$$R = \frac{j_{ref}}{j_{inc}} = \left(\frac{\hbar k/m |B|^2}{\hbar k/m |A|^2} \right)^2 = (|B/A|^2)^2 = \left[\left(\frac{B}{A} \right) * \left(\frac{B}{A} \right) \right]^2$$

$$= \left(\frac{(\gamma^2 - k^2)^2 (e^{2\gamma L} - 1)^2}{[(\gamma^2 - k^2)(1 - e^{2\gamma L})^2 + 4k^2\gamma^2(1 + e^{2\gamma L})^2]} \right) \left(\frac{(\gamma^2 - k^2)^2 (e^{2\gamma L} - 1)^2}{[(\gamma^2 - k^2)(1 - e^{2\gamma L})^2 + 4k^2\gamma^2(1 + e^{2\gamma L})^2]} \right)$$

After dividing the numerator and denominator by $(1 - e^{2\gamma L})^2$ one gets

$$\begin{aligned}
 R^2 &= \left(\frac{(\gamma^2 - k^2)^2}{\left[(\gamma^2 - k^2)^2 + 4k^2\gamma^2 \left\{ \frac{(1+e^{2\gamma L})}{(1-e^{2\gamma L})} \right\}^2 \right]} \right) \left(\frac{(\gamma^2 - k^2)^2}{\left[(\gamma^2 - k^2)^2 + 4k^2\gamma^2 \left\{ \frac{(1+e^{2\gamma L})}{(1-e^{2\gamma L})} \right\}^2 \right]} \right) \\
 O_2 \\
 &= \frac{(\gamma^2 - k^2)^2}{(\gamma^2 - k^2) + 4k^2\gamma^2 \left(\frac{1+e^{4\gamma L} + 2e^{2\gamma L}}{1+e^{4\gamma L} - 2e^{2\gamma L}} - 1 \right) + 4k^2\gamma^2} \\
 &= \left(\frac{(\gamma^2 - k^2)^2}{(\gamma^2 - k^2) + 4k^2\gamma^2 \left\{ \frac{4}{(e^{2\gamma L} + e^{-2\gamma L} - 2)} \right\}} \right) \left(\frac{(\gamma^2 - k^2)^2}{(\gamma^2 - k^2) + 4k^2\gamma^2 \left\{ \frac{4}{(e^{2\gamma L} + e^{-2\gamma L} - 2)} \right\}} \right) \\
 R^2 &= \frac{(\gamma^2 - k^2)^2}{(\gamma^2 - k^2) + \frac{4k^2\gamma^2 \cdot 1}{\left(\frac{e^{\gamma L} - e^{-\gamma L}}{2} \right)^2}} \\
 &= \frac{(\gamma^2 - k^2)^2}{\left[(\gamma^2 - k^2) + \frac{4k^2\gamma^2\gamma^2}{\sin^2 \hbar\gamma L} \right]} \\
 &\quad (17)
 \end{aligned}$$

After substituting the values of γ^2 and k^2 , one gets

$$\begin{aligned}
 R^2 &= \left(\frac{V_0^2}{\left[V_0^2 + \frac{4E(V_0 - E)}{\sin \hbar\alpha L} \right]} \right) \left(\frac{V_0^2}{\left[V_0^2 + \frac{4E(V_0 - E)}{\sin \hbar\alpha L} \right]} \right) \\
 &= \left[1 + \frac{4E(V_0 - E)}{V_0^2 \sin \hbar\alpha L} \right]^{-1} \times \left[1 + \frac{4E(V_0 - E)}{V_0^2 \sin \hbar\alpha L} \right]^{-1} \quad (18)
 \end{aligned}$$

The probability of finding the particle in a region $X > 0$, is given the name transmission coefficient T and using equation (15) we have

$$\begin{aligned}
 T^2 &= \frac{j_{ref}}{j_{inc}} = \left(\frac{\hbar k/m |F|^2}{\hbar k/m |A|^2} \right)^2 = \left(\frac{|F|^2}{|A|^2} \right)^2 = \left[\left(\frac{F}{A} \right) * \left(\frac{F}{A} \right) \right]^2 \\
 &= \left(\frac{16k^2\gamma^2 e^{2\gamma L}}{\left[(\gamma^2 - k^2)(1 - e^{2\gamma L})^2 + 4k^2\gamma^2(1 + e^{2\gamma L})^2 \right]} \right) \left(\frac{16k^2\gamma^2 e^{2\gamma L}}{\left[(\gamma^2 - k^2)(1 - e^{2\gamma L})^2 + 4k^2\gamma^2(1 + e^{2\gamma L})^2 \right]} \right) \\
 &= \left(\frac{16k^2\gamma^2}{(\gamma^2 - k^2)^2(e^{2\gamma L} + e^{-2\gamma L} - 2) + 4k^2\gamma^2(e^{2\gamma L} + e^{-2\gamma L} + 2)} \right) \left(\frac{16k^2\gamma^2}{(\gamma^2 - k^2)^2(e^{2\gamma L} + e^{-2\gamma L} - 2) + 4k^2\gamma^2(e^{2\gamma L} + e^{-2\gamma L} + 2)} \right) \\
 \text{Adding and subtracting } 4k^2\gamma^2(e^{2\gamma L} + e^{-2\gamma L} - 2) \text{ from the denominator, one get} \\
 &= \left(\frac{16k^2\gamma^2}{(\gamma^2 - k^2)^2(e^{2\gamma L} + e^{-2\gamma L} - 2) + 16k^2\gamma^2} \right) \left(\frac{16k^2\gamma^2}{(\gamma^2 - k^2)^2(e^{2\gamma L} + e^{-2\gamma L} - 2) + 16k^2\gamma^2} \right) \\
 &= \left(\frac{4k^2\gamma^2}{\left[(\gamma^2 - k^2)^2 \left(\frac{e^{\gamma L} - e^{-\gamma L}}{2} \right)^2 + 4k^2\gamma^2 \right]} \right) \left(\frac{4k^2\gamma^2}{\left[(\gamma^2 - k^2)^2 \left(\frac{e^{\gamma L} - e^{-\gamma L}}{2} \right)^2 + 4k^2\gamma^2 \right]} \right)
 \end{aligned}$$



$$= \left(\frac{4k^2\gamma^2}{(\gamma^2 - k^2)^2 \sin^2 \gamma L + 4k^2\gamma^2} \right) \left(\frac{4k^2\gamma^2}{(\gamma^2 - k^2)^2 \sin^2 \gamma L + 4k^2\gamma^2} \right) \quad (19)$$

Putting the value of γ^2 and k^2 one gets

$$T^2 = \left[1 + \frac{V_0^2 \sin^2 \alpha L}{4E(V_0 - E)} \right]^{-1} \times \left[1 + \frac{V_0^2 \sin^2 \alpha L}{4E(V_0 - E)} \right]^{-1} \quad (20)$$

One may, however check that $R + T = 1$. There are two interesting situations in which equations (17) to (20) become simpler considering the purely formal limit in which $\hbar \rightarrow 0$. The quantity \hbar is a physical constant, but we can consider as a mathematical variable in order to examine the classical limit of our formulas. As $\hbar \rightarrow 0$, k and γ approach infinity and hence $T \rightarrow 0$, $R \rightarrow 1$, which is of course, the proper behavior of a classical particle with $E < V_0$. The other interesting limit occurs for high and wide barrier, that is, when $\gamma \gg 1$. In that case $\sin^2 \gamma L \approx \frac{1}{2} e^{\gamma L}$, hence from (3.20) after neglecting 1 in comparison to the other which is very large, one gets

$$T^2 = \left(\frac{4E(V_0 - E)}{V_0^2 \left[\frac{1}{2} e^{-2\left\{ \frac{2m(V_0 - E)}{\hbar^2} \right\}^{\frac{1}{2}} L} \right]^2} \right) \left(\frac{4E(V_0 - E)}{V_0^2 \left[\frac{1}{2} e^{-2\left\{ \frac{2m(V_0 - E)}{\hbar^2} \right\}^{\frac{1}{2}} L} \right]^2} \right) \\ = \left(16 \frac{E}{V_0} \left(1 - \frac{E}{V_0} \right) e^{-2\left\{ \frac{2m(V_0 - E)}{\hbar^2} \right\}^{\frac{1}{2}} L} \right) \left(16 \frac{E}{V_0} \left(1 - \frac{E}{V_0} \right) e^{-2\left\{ \frac{2m(V_0 - E)}{\hbar^2} \right\}^{\frac{1}{2}} L} \right) \quad (21)$$

From equation (21) transmission coefficient would be given by

$$T^2 = \left(16 \frac{E}{V_0} \left[1 - \frac{E}{V_0} \right] e^{-2\gamma L} \right) \left(16 \frac{E}{V_0} \left[1 - \frac{E}{V_0} \right] e^{-2\gamma L} \right) \quad (22)$$

$\gamma L \gg 1$, the most important factor in the above equation is the exponential. The factor in front of the exponential which is of the order of 2 is not significant since its variation with V and E is negligible as compared to the variation in exponential itself (Chaddha, 1983). Hence we can write

$$\ln T^2 \simeq -4\gamma L \quad (23)$$

For a rectangular double thick potential barrier of thickness dx , we can write

$$\ln T^2 \simeq -4\gamma dx \quad (24)$$

Where

$$\gamma^4 = \left(\frac{2m}{\hbar^2} [V(x) - E] \right) \left(\frac{2m}{\hbar^2} [V(x) - E] \right) \\ = \left(\frac{2m}{\hbar^2} \left[\left(\frac{2Ze^2}{4\pi\epsilon_0 x} \right) - E \right] \right) \left(\frac{2m}{\hbar^2} \left[\left(\frac{2Ze^2}{4\pi\epsilon_0 x} \right) - E \right] \right) \quad (25)$$

making γ a function of x

Equation (25) expression for the transmission coefficient or tunneling probability of a rectangular barrier. The actual barrier encountered by gamma particle has an exponential tail. We can approximate it as consisting of many rectangular barrier of decreasing height and obtain the total probability by summing the tunneling probability of each barrier the region between r_0 and r_1 . In this entire region, of course $E < V$. Hence taking the summation over all the rectangular potential barriers, we gets

$$\ln T^2 = \left(-2 \int_{r_0}^{r_1} \gamma(x) dx \right) \left(-2 \int_{r_0}^{r_1} \gamma(x) dx \right) \quad (26)$$

From equation (3.25) that γ can be while is a function of x

$$\gamma = \left(\left(\frac{2m}{\hbar} \right)^{\frac{1}{2}} \left(\left(\frac{2Ze^2}{4\pi\epsilon_0 x} \right) - E \right)^{\frac{1}{2}} \right) \left(\left(\frac{2m}{\hbar} \right)^{\frac{1}{2}} \left(\left(\frac{2Ze^2}{4\pi\epsilon_0 x} \right) - E \right)^{\frac{1}{2}} \right) \quad (27)$$

Substituting equation (27) in to equation (26)

$$\ln T^2 = \left(-2 \int_{r_0}^{r_1} \left(\frac{2m}{\hbar} \right)^{\frac{1}{2}} \left(\left(\frac{2Ze^2}{4\pi\epsilon_0 x} \right) - E \right)^{\frac{1}{2}} dx \right) \left(-2 \int_{r_0}^{r_1} \left(\frac{2m}{\hbar} \right)^{\frac{1}{2}} \left(\left(\frac{2Ze^2}{4\pi\epsilon_0 x} \right) - E \right)^{\frac{1}{2}} dx \right) \quad (28)$$

Making use of equation (21), leads to

$$\ln T^2 = \left(-2 \left(\frac{2m}{\hbar} \right)^{\frac{1}{2}} \int_{r_0}^{r_1} \left(\frac{r_0}{x} - 1 \right)^{\frac{1}{2}} dx \right) \left(-2 \left(\frac{2m}{\hbar} \right)^{\frac{1}{2}} \int_{r_0}^{r_1} \left(\frac{r_0}{x} - 1 \right)^{\frac{1}{2}} dx \right) \quad (29)$$

Putting $x = r_1 \cos^2 \theta$, $dx = r_1 2 \cos \theta (-\sin \theta d\theta)$ and also changing the limits to

θ (at $x = r_0$, $\theta_0 = \cos^{-1} \left(\frac{r_0}{x} \right)^{\frac{1}{2}}$ and at $x = r_0$, $\theta_0 = 0$), one gets

$$\ln T^2 = \left(-2 \left(\frac{2m E}{\hbar} \right)^{\frac{1}{2}} r_1 \int_0^{\theta_0} \left(\frac{1}{\cos^2 \theta} - 1 \right)^{\frac{1}{2}} \sin \theta \cos \theta dx \right) \left(-2 \left(\frac{2m E}{\hbar} \right)^{\frac{1}{2}} r_1 \int_0^{\theta_0} \left(\frac{1}{\cos^2 \theta} - 1 \right)^{\frac{1}{2}} \sin \theta \cos \theta dx \right) \quad (30)$$

Since

$$\left(\left(\frac{1}{\cos^2 \theta} - 1 \right)^{\frac{1}{2}} \right)^2 = \left(\frac{(1 - \cos^2 \theta)^{\frac{1}{2}}}{\cos \theta} \right)^2 = \left(\frac{\sin \theta}{\cos \theta} \right)^2$$

The double thick potential barrier is on the x coordinate

$$\ln T^2 = \left(-2 \left(\frac{2m E}{\hbar} \right)^{\frac{1}{2}} r_1 \int_0^{\theta_0} \sin^2 \theta d\theta \right) \left(-2 \left(\frac{2m E}{\hbar} \right)^{\frac{1}{2}} r_1 \int_0^{\theta_0} \sin^2 \theta d\theta \right) \quad (31)$$

Using trigonometric rule and integrating



$$\ln T^2 = \left(-2 \left(\frac{2mE}{\hbar} \right)^{\frac{1}{2}} r_1 \int_0^{\theta_0} \frac{1 - \cos 2\theta}{2} d\theta \right) \left(-2 \left(\frac{2mE}{\hbar} \right)^{\frac{1}{2}} r_1 \int_0^{\theta_0} \frac{1 - \cos 2\theta}{2} d\theta \right) \quad (32)$$

$$= \left(-2 \left(\frac{2mE}{\hbar} \right)^{\frac{1}{2}} r_1 \int_0^{\theta_0} \left(\frac{1}{2} - \frac{\cos 2\theta}{2} \right) d\theta \right) \left(-2 \left(\frac{2mE}{\hbar} \right)^{\frac{1}{2}} r_1 \int_0^{\theta_0} \left(\frac{1}{2} - \frac{\cos 2\theta}{2} \right) d\theta \right) \quad (33)$$

$$= \left(-2 \left(\frac{2mE}{\hbar} \right)^{\frac{1}{2}} r_1 \int_0^{\theta_0} \frac{1}{2} d\theta - \frac{1}{2} \int_0^{\theta_0} \cos 2\theta d\theta \right) \left(-2 \left(\frac{2mE}{\hbar} \right)^{\frac{1}{2}} r_1 \int_0^{\theta_0} \frac{1}{2} d\theta - \frac{1}{2} \int_0^{\theta_0} \cos 2\theta d\theta \right) \quad (34)$$

$$= \left(-2 \left(\frac{2mE}{\hbar} \right)^{\frac{1}{2}} r_1 \left(\frac{1}{2} \int_0^{\theta_0} d\theta - \frac{1}{2} \int_0^{\theta_0} \cos 2\theta d\theta \right) \right) \left(-2 \left(\frac{2mE}{\hbar} \right)^{\frac{1}{2}} r_1 \left(\frac{1}{2} \int_0^{\theta_0} d\theta - \frac{1}{2} \int_0^{\theta_0} \cos 2\theta d\theta \right) \right) \quad (35)$$

$$= \left(-2 \left(\frac{2mE}{\hbar} \right)^{\frac{1}{2}} r_1 (\theta_0 - (\cos^2 \theta - \sin^2 \theta)) \right) \left(-2 \left(\frac{2mE}{\hbar} \right)^{\frac{1}{2}} r_1 (\theta_0 - (\cos^2 \theta - \sin^2 \theta)) \right) \quad (36)$$

$$= \left(-2 \left(\frac{2mE}{\hbar} \right)^{\frac{1}{2}} r_1 (\theta_0 - (\cos^2 \theta - (1 - \cos^2 \theta))) \right) \left(-2 \left(\frac{2mE}{\hbar} \right)^{\frac{1}{2}} r_1 (\theta_0 - (\cos^2 \theta - (1 - \cos^2 \theta))) \right) \quad (37)$$

$$= \left(-2 \left(\frac{2mE}{\hbar} \right)^{\frac{1}{2}} r_1 (\theta_0 - (\cos^2 \theta + \cos^2 \theta - 1)) \right) \left(-2 \left(\frac{2mE}{\hbar} \right)^{\frac{1}{2}} r_1 (\theta_0 - (\cos^2 \theta + \cos^2 \theta - 1)) \right) \quad (38)$$

$$= \left(-2 \left(\frac{2mE}{\hbar} \right)^{\frac{1}{2}} r_1 (\theta_0 - (2 \cos^2 \theta - 1)) \right) \left(-2 \left(\frac{2mE}{\hbar} \right)^{\frac{1}{2}} r_1 (\theta_0 - (2 \cos^2 \theta - 1)) \right) \quad (39)$$

After putting the value of E

$$\ln T^2 =$$

$$\left(-2 \left[\left(\frac{2m}{\hbar} \right)^{\frac{1}{2}} \frac{2Ze^2}{4\pi\epsilon_0 r_1} \right]^{1/2} \left[\cos^{-1} \left(\frac{r_0}{r_1} \right)^{\frac{1}{2}} - \left(\frac{r_0}{r_1} \right)^{\frac{1}{2}} \left(1 - \frac{r_0}{r_1} \right)^{\frac{1}{2}} \right] \right) \left(-2 \left[\left(\frac{2m}{\hbar} \right)^{\frac{1}{2}} \frac{2Ze^2}{4\pi\epsilon_0 r_1} \right]^{1/2} \left[\cos^{-1} \left(\frac{r_0}{r_1} \right)^{\frac{1}{2}} - \left(\frac{r_0}{r_1} \right)^{\frac{1}{2}} \left(1 - \frac{r_0}{r_1} \right)^{\frac{1}{2}} \right] \right) \quad (40)$$

Because of the fact that the potential barrier is relatively wide, $r_1 \gg r_0$,

$$\cos^{-1} \left(\frac{r_0}{x} \right)^{\frac{1}{2}} \approx \frac{\pi}{2} - \left(\frac{r_0}{x} \right)^{\frac{1}{2}}$$

$$\text{As } \cos \left\{ \frac{\pi}{2} - \left(\frac{r_0}{r_1} \right)^{\frac{1}{2}} \right\} = \sin \left(\frac{r_0}{r_1} \right)^{\frac{1}{2}} \approx \left(\frac{r_0}{r_1} \right)^{\frac{1}{2}}$$

$$\text{If } \left(\frac{r_0}{r_1} \right) \ll 1$$

Also

$$\left(\frac{r_0}{r_1} \right)^{\frac{1}{2}} \approx \left(\frac{r_0}{r_1} \right)^{\frac{1}{2}} \approx 1$$

Hence from equation (39)

$$\ln T^2 = \left(-2 \left(\left(\frac{2m}{\hbar} \right)^{\frac{1}{2}} \frac{2Ze^2}{4\pi\epsilon_0 r_1} \right)^{\frac{1}{2}} \left[\pi/2 - 2 \left(\frac{r_0}{r_1} \right)^{\frac{1}{2}} \right] \right) \left(-2 \left(\left(\frac{2m}{\hbar} \right)^{\frac{1}{2}} \frac{2Ze^2}{4\pi\epsilon_0 r_1} \right)^{\frac{1}{2}} \left[\pi/2 - 2 \left(\frac{r_0}{r_1} \right)^{\frac{1}{2}} \right] \right) \quad (41)$$

Replacing r_1 by $r_1 = \frac{2Ze^2}{4\pi\epsilon_0}$ and simplifying

$$\ln T^2 = \left(4 \frac{e}{\hbar} \left(\frac{m}{\pi\epsilon_0} \right)^{\frac{1}{2}} Z^{\frac{1}{2}} r_0^{\frac{1}{2}} - \frac{e^2}{\hbar\epsilon_0} \left(\frac{m}{2} \right)^{\frac{1}{2}} Z E^{-\frac{1}{2}} \right) \left(4 \frac{e}{\hbar} \left(\frac{m}{\pi\epsilon_0} \right)^{\frac{1}{2}} Z^{\frac{1}{2}} r_0^{\frac{1}{2}} - \frac{e^2}{\hbar\epsilon_0} \left(\frac{m}{2} \right)^{\frac{1}{2}} Z E^{-\frac{1}{2}} \right) \quad (42)$$

$$\ln T^2 = 4^2 \left(\frac{e}{\hbar} \right)^2 \left(\frac{m}{\pi\epsilon_0} \right) Z^{\frac{1}{2}} r_0^{\frac{1}{4}} - \frac{e^4}{(\hbar\epsilon_0)^2} \left(\frac{m}{2} \right) Z^2 E^{-\frac{1}{4}} \quad (43)$$

Equation (43) gives the natural logarithm of the tunneling probability of the gamma particle.

Results

We assess the ability of gamma particle in tunneling through a barrier, its relationship with decay constant and half-life using equation (43)

$$\ln T^2 = 4^2 \underbrace{\frac{e^2}{\hbar^2} \left(\frac{m}{\pi\epsilon_0} \right) Z^{\frac{1}{2}} r_0^{\frac{1}{4}}}_{I_1} - \underbrace{\frac{e^4}{(\hbar\epsilon_0)^2} \left(\frac{m}{2} \right) Z^2 E^{-\frac{1}{4}}}_{I_2} \quad 43$$

The constant I_1 and I_2 are to be calculated while:

Z = atomic number of the daughter nucleus (the gamma emitting nucleus)

$$r_0 = 1.1 \left(A_d^{\frac{1}{2}} + A_\gamma^{\frac{1}{2}} \right) \times 10^{-15} m \text{ (for each nucleus)} \quad 44$$

E = Potential energy of the emitted gamma particle

= or energy of decay for each nucleus

m = mass of gamma particle

1 atomic mass unit = $1.66 \times 10^{-27} kg$

$$\left. \begin{aligned} e &= 1.6 \times 10^{-19} C \\ \hbar &= 1.05477 \times 10^{-34} Js \\ \epsilon_0 &= 8.85 \times 10^{-12} Farad/m \end{aligned} \right\} \text{all are in S.I unit}$$

To keep equation (3.64) as simple as possible we calculate the constant I_1 and I_2

$$I_1 = 4^2 \frac{e^2}{\hbar^2} \left(\frac{m}{\pi\epsilon_0} \right) \quad 45$$

$$I_1 = 8.792420946 \times 10^{15}$$

46



$$I_2 = \frac{e^4}{(\hbar\epsilon_0)^2} \left(\frac{m}{2}\right) \quad 47$$

$$I_2 = 2.496984634 \times 10^{-12}$$

48

$$K_1 = T^2 \quad 49$$

Let T^2 be DT

$$K_1 = DT \quad 50$$

$$\ln DT = 8.792420946 \times 10^{15} Z^4 r_0^{\frac{1}{4}} - 2.496984634 \times 10^{-12} Z^2 E^{-\frac{1}{4}}$$

51

Equation (51) is used to get the result for tunneling for every γ emitting nucleus as show in Table 4.1

The decay probability per unit time or constant we write

$$\lambda = \Gamma T \quad 52$$

Where Γ = number of time per second gamma particle within a nucleus strikes the potential barrier

T = the probability of transmission through the barrier.

Assume only one gamma particle exists within a nucleus moving to and fro in the nuclear diameter

$$\Gamma = \frac{v}{2r_0}$$

53

Where $v = \gamma$ particle velocity when it finally leaves the nucleus

$$\lambda = \frac{v}{2r_0} DT \quad 54$$

$$v = 10^7 \text{ms}^{-1}, r_0 = 10^{-14} \text{m}$$

$$\lambda = \frac{10^7}{2 \times 10^{-14}} DT \approx 10^{-21} DT$$

55

Equation (55) can be used to get the result for decay probability per unit time.

The half life $t_{\frac{1}{2}}$ is the time taken for half the original number of atom present to decay.

Mathematically half-life $t_{\frac{1}{2}}$ can written as

$$t_{\frac{1}{2}} = \frac{\ln 2}{\lambda} \quad 56$$

Substitute equation (56) into (55) gives

Table 1: ${}^{75}_{36}\text{Kr}$ to ${}^{157}_{70}\text{Yb}$ gamma particle emitting nuclei and their decay probability

S/ N	Nucleus (name)	Mass No. (A)	Z	Mass Excess A(KeV)	r_0	E γ (J)	$\ln DT(E12)$	DT	Decay constant (E-20)	Half-life (E23) $t_{\frac{1}{2}}$
1	Kr	75	36	132.4	9.526279442	1.081469678E-14	6.728293536	29.53734267	2.953734267	2.046937849
2	Rb	76	37	257.1	9.589577676	3.97566408E-13	6.785920598	29.54587108	2.954587108	2.047528866
3	Sr	80	38	589.0	9.838699101	2.146917582E-14	6.82001297	29.55088249	2.956088249	2.047846157
4	Y	80	39	385.9	9.838699101	4.524548695E-14	6.920046991	29.56544368	2.956544368	2.048885247

Theoretical Evaluation of Step Approaching Zero Emission on a Double Thick Barrier of a Gamma Particle

5	Y	81	39	124.2	9.90	1.357044773E-14	6.930800892	29.56699649	2.956699649	2.046937847
6	Y	87	39	484.5	10.26011696	5.34005694E-14	6.992986692	29.5792886	2.9592886	2.04961187
7	Z ₂	80	40	311.0	9.838699101	5.12696736E-15	6.963896005	29.57177313	2.957177313	2.049323878
8	Z ₂	85	40	416.5	10.1414989	2.552670702E-14	7.016960099	29.57935121	2.957935121	2.049849036
9	Z ₂	89	40	909.1	10.37737925	6.802844816E-14	7.056410711	29.58509935	2.958509935	2.050247385
10	Z ₂	90	40	2186.2	10.43551628	5.609222727E-14	7.06727447	29.58649601	2.958649601	2.050344713
11	Nb	84	41	540.0	10.08166653	6.584948703E-14	6.995280444	29.57625182	2.957625182	2.049634598
12	Nb	86	41	751.7	10.20098035	1.02411713E-13	7.070740754	29.58698636	2.958698636	2.050378155
13	Nb	88	41	1057.1	10.31891467	1.026354778E-13	7.09112895	29.58986568	2.958986568	2.050577692
14	Nb	89	41	1627.7	10.37737952	2.285505918E-13	7.101111936	29.5912725	2.95912725	2.050695184
15	Mo	106	42	465.7	11.32519316	4.381954416E-14	7.30182856	29.51915492	2.961915492	2.052606812
16	Mo	107	42	400.3	11.37848848	4.897856006E-14	7.310413426	29.62032094	2.962032094	2.052688241
17	Tc	88	43	741.0	10.31891467	1.10742495E-13	7.176027451	29.60716707	2.960716707	2.051402458
18	Tc	90	43	948.1	10.43551628	1.24525198E-13	7.19621402	29.6045747	2.96045747	2.05159687
19	Tc	91	43	653.0	10.94486181	8.558831137E-14	7.282460819	29.61648995	2.961648995	2.052422754
20	Ru	91	44	393.7	10.49333122	4.401181043E-14	7.24616298	29.61770478	2.961770478	2.052091141
21	Ru	97	44	215.7	10.83374358	1.858525668E-15	7.30574774	29.61968622	2.961968622	2.052644255
22	Ru	105	44	724.3	11.27164584	6.05462807E-14	7.378506638	29.62959239	2.962959239	2.05330753
23	Rh	92	45	893.0	10.55082935	1.183047718E-13	7.29849391	29.61868913	2.961868913	2.052575157
24	Rh	94	45	756.2	10.66489569	8.690209675E-14	7.318140675	29.62137741	2.962137741	2.052761454
25	Rh	96	45	832.6	10.7775487	7.459737509E-14	7.337425015	29.62400908	2.962400908	2.052943829
26	Rh	99	45	341.0	10.94486181	2.007528157E-14	7.365702458	29.62785554	2.962785554	2.053210389
27	Pd	115	46	749.0	11.79618582	6.410311377E-14	7.54267371	29.6207549	2.96207549	2.054888832
28	Pd	117	46	247.3	11.898831921	1.912999696E-14	7.56256872	29.65423203	2.965423203	2.055038279
29	Ag	95	47	1261.2	10.72147378	1.636634412E-13	7.407924692	29.63357145	2.963357145	2.053606501
30	Ag	99	47	342.6	10.94486181	1.238483053E-14	7.446213897	29.63872682	2.963872682	2.053963768
31	Cd	100	48	936.6	11.0	1.77600316E-14	7.494919158	29.64524646	2.964524646	2.054415558
32	Cd	105	48	961.8	11.27164584	1.350795682E-13	7.540786622	29.65134513	2.965134513	2.054838224
33	In	104	49	658.0	11.27164584	2.834251644E-14	7.570678971	29.65530387	2.965530387	2.055112558
34	In	106	49	632.6	11.32519316	8.797555554E-14	7.588726425	29.6576849	2.96576849	2.055277564
35	Sn	105	50	1281.7	11.27164584	1.7522461531E-13	7.618119947	29.66155073	2.966155073	2.055545466
36	Sn	107	50	678.6	11.37848848	8.765512008E-14	7.63610396	29.66390929	2.966390929	2.055703914
37	Sb	108	51	1205.8	11.43153533	1.312663862E-13	7.682934965	29.67002275	2.967002275	2.056132577
38	Sb	112	51	1257.1	11.64130577	1.56548744E-13	7.71940754	29.6745687	2.96745687	2.056447611
39	Te	113	52	814.0	11.69316039	1.056956365E-13	7.72651097	29.67567851	2.967567851	2.056524521
40	Te	115	52	770.4	11.79618582	4.364330965E-14	7.781166519	29.68272734	2.968272734	2.057013005
41	I	112	53	689.0	11.64130577	9.308650113E-14	7.79251889	29.68418527	2.968418527	2.057114039
42	I	114	53	708.8	11.74478608	5.380111373E-14	7.809778513	29.68639772	2.968639772	2.057267262
43	Xe	135	54	786.9	12.78084504	2.235037334E-14	8.013953247	29.71220529	2.971220529	2.059055827
44	Xe	140	54	805.6	13.01537552	3.471918209E-14	8.050467255	29.71675125	2.971675125	2.059370862
45	Cs	116	55	393.5	11.84736258	1.361850705E-14	7.8995902	29.697832	2.9697832	2.058059134
46	Cs	125	55	525.0	12.29837388	6.025788825E-14	7.973712585	29.70717245	2.970717245	2.05870705
47	Ba	126	56	233.6	12.34746938	3.52479006E-15	8.0770307	29.7126731	2.97126731	2.059088246
48	Ba	143	56	211.5	13.15405652	2.611548999E-14	8.145554522	29.72849344	2.972849344	2.060184595
49	La	126	57	256.0	12.34746938	1.385883365E-14	8.053259166	29.71709799	2.971709799	2.059394591
50	La	130	57	357.4	12.54192968	1.345828932E-14	7.533071049	29.65032392	2.965032392	2.054767448
51	Ce	127	58	120.4	12.39637044	8.395409052E-15	7.30574775	29.61928622	2.961928622	2.052644255
52	Ce	133	58	477.2	12.68581885	5.913636414E-14	7.378506684	29.62959239	2.962959239	2.05330752
53	Pr	129	59	203.8	12.49359836	1.336215868E-14	7.2984939176	29.61868913	2.961868913	2.052575157
54	Pr	137	59	836.9	12.8751699	9.989575466E-14	7.318140675	29.62137741	2.962137741	2.052761455
55	Nd	133	60	402.8	12.68581885	4.24256549E-14	7.337425015	29.62400708	2.962400708	2.05293829
56	Nd	152	60	278.6	13.5671081	2.377661113E-14	7.365702458	29.62785564	2.962785564	2.053210389
57	Pm	136	61	373.7	12.8280947	3.37578751E-14	7.546278371	29.65207549	2.965207549	2.048888832
58	Sm	137	62	380.5	12.8751699	2.911156154E-14	7.56256872	29.65423205	2.965423205	2.055638279
59	Eu	139	63	719.0	12.96880873	5.423370161E-14	7.407924692	29.63357145	2.963357145	2.053606501
60	Gd	159	64	363.0	13.87047223	4.792112304E-14	7.446213799	29.63872782	2.963872782	2.053963758
61	Tb	144	65	284.0	13.20	1.683888342E-14	8.462471713	29.76662342	2.976662342	2.062827003



62	Dy	145	66	578.2	13.24575404	8.542809364E-14	8.501853707	29.77130541	2.977130534	2.06315146
63	Ho	146	67	682.7	13.29135057	7.786581678E-14	8.541211008	29.77592392	2.977592392	2.063471528
64	Er	151	68	1140.2	13.5770263	1.691899229E-14	8.609065064	29.78383684	2.978383684	2.064019893
65	Tm	152	69	808.2	13.56711081	5.322432991E-14	8.647675105	29.78831163	2.978831163	2.064329996
66	Yb	157	70	231.1	1379296049	2.291113539E-14	8.714021135	29.79595447	2.979595447	2.064859645

$$t_{\frac{1}{2}} = \frac{\ln 2}{10^{-21}DT} \quad (57)$$

This equation gives the result for half-life of gamma emitting nucleus substitute equation (57) into (51)

$$t_{\frac{1}{2}} = \frac{\ln 2}{10^{-21}} e^{-\left[4^2 \frac{e^2}{\hbar^2} \left(\frac{m}{\pi \epsilon_0}\right) Z^{\frac{1}{4}} r_0^{\frac{1}{4}} - \frac{e^4}{(\hbar \epsilon_0)^2} \left(\frac{m}{2}\right) Z^2 E^{-\frac{1}{4}}\right]} \quad (58)$$

$$t_{\frac{1}{2}} = 6.93 \times 10^{21} \times e^{-\left[8.792420946 \times 10^{15} Z^{\frac{1}{4}} r_0^{\frac{1}{4}} - 2.496984634 \times 10^{-12} Z^2 E^{-\frac{1}{4}}\right]} \quad (59)$$

Table 2: $^{75}_{36}\text{Kr}$ to $^{157}_{70}\text{Yb}$ gamma particle emitting nuclei and their calculated and experimental half lives

S/N	Nucleus (name)	Mass No. (A)	Z	E γ (J)	ln DT (E12)	DT	Log Decay constant	Log Half-life $t_{\frac{1}{2}}$	Log Half-life $t_{\frac{1}{2}}$ (from chart)
1	Kr	75	36	1.081469678E-14	6.728293536	29.53734267	-19.52962858	23.31110466	2.411619406
2	Rb	76	37	3.97566408E-13	6.785920598	29.54587108	-19.529032	23.31123003	1.568201724
3	Sr	80	38	2.146977582E-14	6.82001297	29.55088249	-19.52942955	23.31130369	3.804275767
4	Y	80	39	4.524548695E-14	6.920046991	29.56544368	-19.5292156	23.31151764	0.6812412374
5	Y	81	39	1.357044773E-14	6.930800892	29.56699649	-19.5219279	23.31110466	1.908485019
6	Y	87	39	5.34005694E-14	6.992986692	29.5792886	-19.52901228	23.31167163	3.683407279
7	Zr	80	40	5.12696736E-15	6.963896005	29.57177313	-19.52912263	23.3116106	0.6989700043
8	Zr	85	40	2.552670702E-14	7.016960099	29.57935121	-19.52901136	23.31172188	1.037426498
9	Zr	89	40	6.802844816E-14	7.056410711	29.58509935	-19.52892697	23.31180627	3.672910245
10	Zr	90	40	5.609222727E-14	7.06727447	29.58649601	-19.58728819	23.31182677	2.907945522
11	Nb	84	41	6.584948703E-14	6.995280444	29.57625182	-19.52905679	23.31167644	1.09181246
12	Nb	86	41	1.02411773E-13	7.070740754	29.58698636	-19.52889927	23.31183397	1.942504106
13	Nb	88	41	1.026354778E-13	7.09112895	29.58986568	-19.52885701	23.31187623	2.66464976
14	Nb	89	41	2.285505918E-13	7.101111936	29.5912725	-19.52883836	23.31189688	3.857332496
15	Mo	106	42	4.381954916E-14	7.30182856	29.51915492	-19.52842747	23.31230571	0.9395192526
16	Mo	107	42	4.897856006E-14	7.310413426	29.62032094	-19.52841020	23.31232299	0.5440680444
17	Tc	88	43	1.10742495E-13	7.176027451	29.60776707	-19.52868286	23.31205087	0.806179974
18	Tc	90	43	1.24525198E-13	7.19621402	29.6045747	-19.52864115	23.31209202	1.691965103
19	Tc	91	43	8.558831137E-14	7.282460899	29.61648995	-19.528466	23.31226682	2.29666519
20	Ru	91	44	4.401181043E-14	7.247696298	29.61770478	-19.52853659	23.31219665	2.346352974
21	Ru	97	44	1.858525668E-15	7.305774774	29.61968622	-19.52841955	23.31231369	3.619260335
22	Ru	105	44	6.054628077E-14	7.378506638	29.62959239	-19.52827432	23.31245891	4.203685471
23	Rh	92	45	1.183047718E-13	7.29849397	29.61868913	-19.5284347	23.31229907	0.6989700043
24	Rh	94	45	8.690209675E-14	7.318140675	29.62137741	-19.52839475	23.31233848	1.411619706
25	Rh	96	45	7.459737509E-14	7.337425015	29.62400908	-19.5283567	23.31237707	195128198
26	Rh	99	45	2.007528157E-14	7.365702458	29.62785554	-19.52829978	23.31243345	4.228400359
27	Pd	115	46	6.410311377E-14	7.542677371	29.6207549	-19.5279449	23.31278833	1.698970004
28	Pd	117	46	1.912999696E-14	7.56256872	29.65423203	-19.5279132	23.31281992	0.6434526765
29	Ag	95	47	1.636634412E-13	7.407924692	29.63357145	-19.528216	23.3125723	0.27875601
30	Ag	99	47	1.238483053E-14	7.446213897	29.63872682	-19.52841047	23.31259278	1.041392685
31	Cd	100	48	1.177600316E-14	7.494919158	29.64524646	-19.52804493	23.3126883	1691081492
32	Cd	105	48	1.350795682E-13	7.540768622	29.65134513	-19.5279556	23.3127764	3.522444234

Theoretical Evaluation of Step Approaching Zero Emission on a Double Thick Barrier of a Gamma Particle

33	I_n	104	49	2.834251644E-14	7.570678971	29.65530387	-19.52789762	23.31283561	2.035829825
34	I_n	106	49	8.797555554E-14	7.588726425	29.6576849	-19.52786275	23.31287048	2.502427212
35	S_n	105	50	1.752461531E-13	7.618119947	29.66155073	-19.52780615	23.31292709	1.531478197
36	S_n	107	50	8.765512008E-14	7.63610896	29.66390929	-19.52777162	23.31296162	2.243534107
37	S_b	108	51	1.312663862E-13	7.682934965	29.67002275	-19.5276212	23.31305111	0.8692377197
38	B	112	51	1.56548744E-13	7.717940754	29.6745687	-19.52761558	23.31317765	1.7170963119
39	T_c	113	52	1.056956365E-13	7.72651097	29.67567851	-19.52759934	23.31313389	2.008600772
40	T_c	115	52	4.364330965E-14	7.781166519	29.68272734	-19.5274962	23.31232704	2.604226053
41	I	112	53	9.308650113E-14	7.79251889	29.68418527	-19.52747487	23.31235837	0.531478917
42	I	114	53	5.380111373E-14	7.809778513	29.68639772	-19.5274425	23.31297074	0.7923916895
43	X_c	135	54	2.235037334E-14	8.013953247	29.71220529	-19.52706511	23.31366812	2.962842681
44	X_c	140	54	3.471918209E-14	8.050467255	29.71675125	-19.52699867	23.31345785	1.133538908
45	C_s	116	55	1.361850705E-14	7.8995902	29.697832	-19.52727559	23.31345785	0.84509804
46	C_s	125	55	6.025788825E-14	7.973721585	29.70717245	-19.52713868	23.31354455	3.431363764
47	B_n	126	56	3.52479006E-15	8.01770307	29.7126731	-19.52705828	23.31367496	3.773786445
48	B_n	143	56	2.611548999E-14	8.145554522	29.72849344	-19.5268271	23.31390614	1.155336037
49	L_n	126	57	1.385883365E-14	8.053259166	29.71709799	-19.5269936	23.31373963	1.698770004
50	L_n	130	57	1.345828932E-14	7.533071049	29.65032392	-19.52797056	23.31276268	2.777670503
51	C_c	127	58	8.395409052E-15	7.305774775	29.61928622	-19.52849955	23.31231369	1.531478917
52	C_c	133	58	5.913636414E-14	7.378506684	29.62959239	-19.52827432	23.31245891	2.51054501
53	P_n	129	59	1.336215868E-14	7.298493976	29.61868913	-19.52843471	23.31229907	1.477121255
54	P_n	137	59	9.989575466E-14	7.318140675	29.62137741	-19.52839475	23.31233843	1.88536122
55	N_d	133	60	4.24256549E-14	7.337425015	29.62400708	-19.52835617	23.31237589	1.84509804
56	N_d	152	60	2.377661113E-14	7.365702458	29.62785564	-19.52829978	23.31243345	2.835056102
57	P_m	136	61	3.37578751E-14	7.546278571	29.65207549	-19.5279449	23.31278833	1.67207858
58	S_m	137	62	2.911156154E-14	7.56256872	29.65423205	-19.52791332	23.3129467	1.653212514
59	E_n	139	63	5.423370161E-14	7.40792492	29.63357145	-19.528216	23.31257723	1.255272505
60	G_d	159	64	4.792112304E-14	7.446213799	29.63872782	-19.52814044	23.31251275	3.045322979
61	T_b	144	65	1.683888342E-14	8.462147113	29.76662342	-19.52627043	23.31446281	0.6232492904
62	d_y	145	66	8.542809364E-14	8.501853707	29.77130541	-19.52620212	23.31453111	1.146128036
63	H_o	146	67	7.786581678E-14	8.541211008	29.77592392	-19.526123475	23.31489848	0.5785139399
64	E_n	151	68	1.691899229E-14	8.609065064	29.78383684	-19.526019366	23.31471388	0.7781512504
65	T_m	152	69	5.322432991E-14	8.647675105	29.78831163	-19.52595411	23.31477912	0.6987700043
66	Y_b	157	70	2.291113539E-14	8.714021135	29.79595447	-19.5258427	23.31489054	1.5910064607

Discussion

The results of tunneling probabilities of gamma particle for $^{75}_{36}\text{Kr}$ to $^{157}_{70}\text{Yb}$ nuclei are shown in Tables 1 and 2. Table 1 and 2 have atomic number $Z = 36$ to 70 for $^{75}_{36}\text{Kr}$ to $^{157}_{70}\text{Yb}$ gamma nuclei. The tables that indicate the medium gamma particle has an appropriate result obtained which shows that gamma decay is possible. The calculated tunnel probability in equation (4.8) indicate input data in Table 2. The isotopes of gamma particle emitter with $Z = 36$ to 70 that is $^{75}_{36}\text{Kr} - ^{157}_{70}\text{Yb}$ for medium gamma particle and $Z = 71$ to 101 that is $^{158}_{71}\text{Lu} - ^{256}_{101}\text{Md}$ for heavy gamma particle are shown. The half-life varies from one nucleus to another which indicates that from Table 2 observes that the values of calculated half-lives are so small but also match with the experimental half-lives. In general, the gamma particle half-life $t_{1/2}$ presented in the Table 2 are in agreement with the experimental result (see chart of Nuclides Edwards et al., 2002).

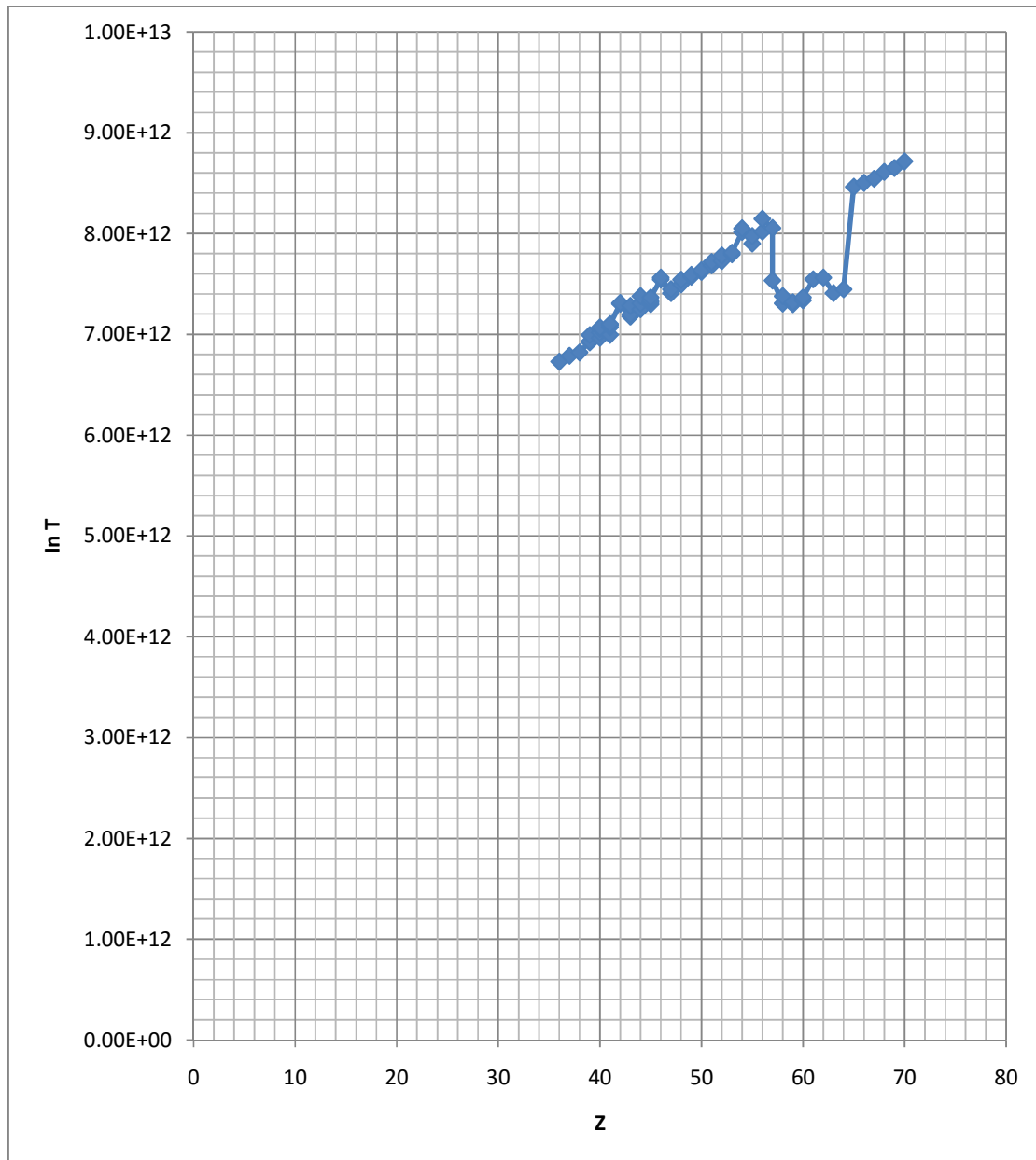

Figure 1: Natural logarithm of Tunneling probability versus Atomic number for $^{75}_{36}\text{Kr}$ to $^{157}_{70}\text{Yb}$ Gamma Particle emitting nuclei.

Figure 1 represents the natural logarithm of tunneling probability versus atomic number Z for $^{75}_{36}\text{Kr}$ to $^{157}_{70}\text{Yb}$ mass gamma particle emitters respectively. Figure 1, the anomaly lies with high atomic number Z values for the medium gamma particle nuclei. From atomic number $Z=42, 44, 46, 48, 52, 54$ and 56 are slightly high than the orders also from atomic number $Z=57$ to 65 makes a shape of "w" and from the atomic number $Z=65$ diminishes with increasing value of natural logarithm of tunneling probability. The reason that anomaly lies at low atomic number Z

is as result of different energy of gamma particle emitters with atomic number Z . The shape "w" is as a result from one nucleus to another, that the nuclei have either very small tunneling probability or the nuclei are stable and are depicted by points lying at the bottom for each isotope which even-even is with even-odd (even neutron and odd proton or even proton and odd neutron) the figure shows that the probability of gamma emission is higher than even-even nuclei. The atomic number $Z=42, 44, 46, 52, 54$ and 56 it shows that even-even nuclei have the slightly high probability of gamma emission.

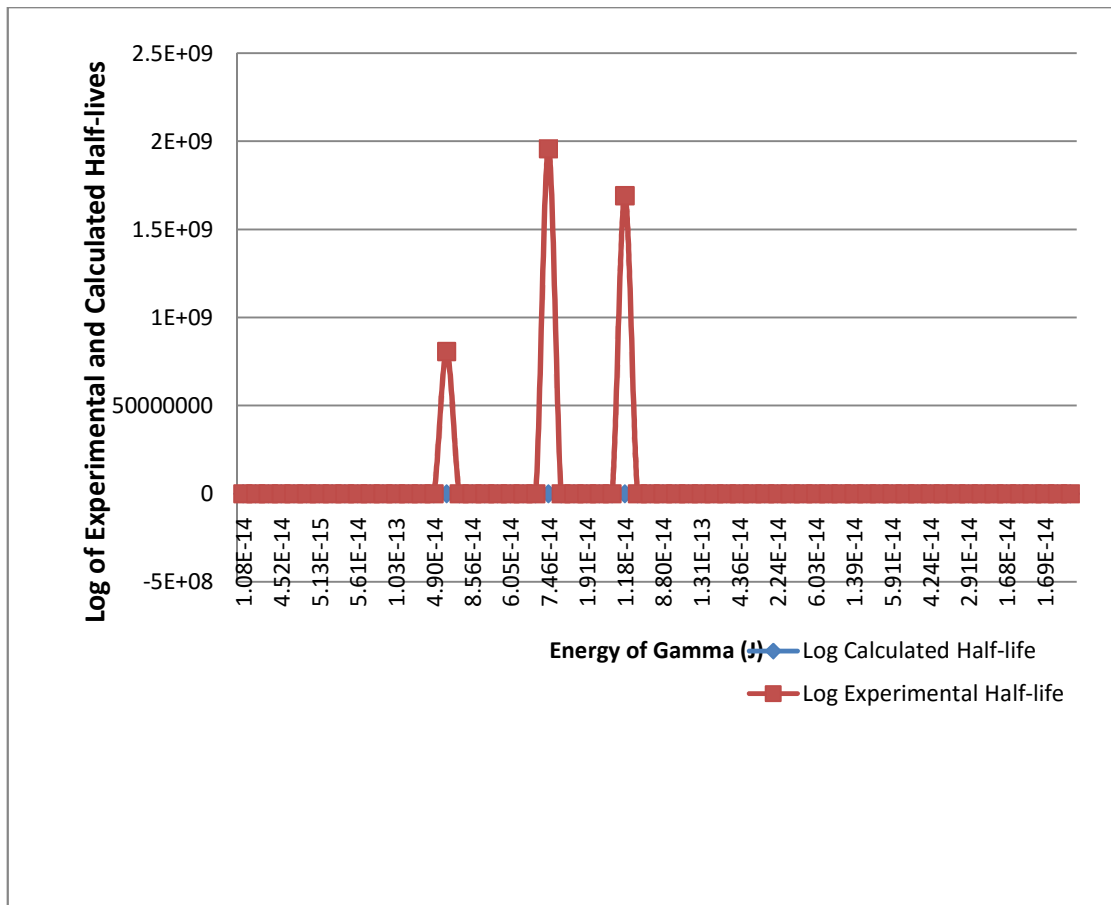

Figure 2: Logarithmic plot of Experimental and Calculated Half-lives versus Energy of Gamma Particle for $^{75}_{36}\text{Kr}$ to $^{157}_{70}\text{Yb}$ mass nuclei.

Figure 2 shows the logarithm of experimental and calculated half-lives versus energy of gamma particle for $^{75}_{36}\text{Kr}$ to $^{157}_{70}\text{Yb}$ mass nuclei. Figure 2, shows the anomaly lies with high energy of gamma particle values of experimental and calculated half-lives except for the three anomalies nuclei of the experimental half-lives that are high energy of gamma particle emitter prove that they have high half-lives experimentally as in the anomalies of the energy of gamma particle are 4.90 E-14 J , 7.46 E-14 J and 1.18 E-14 J .

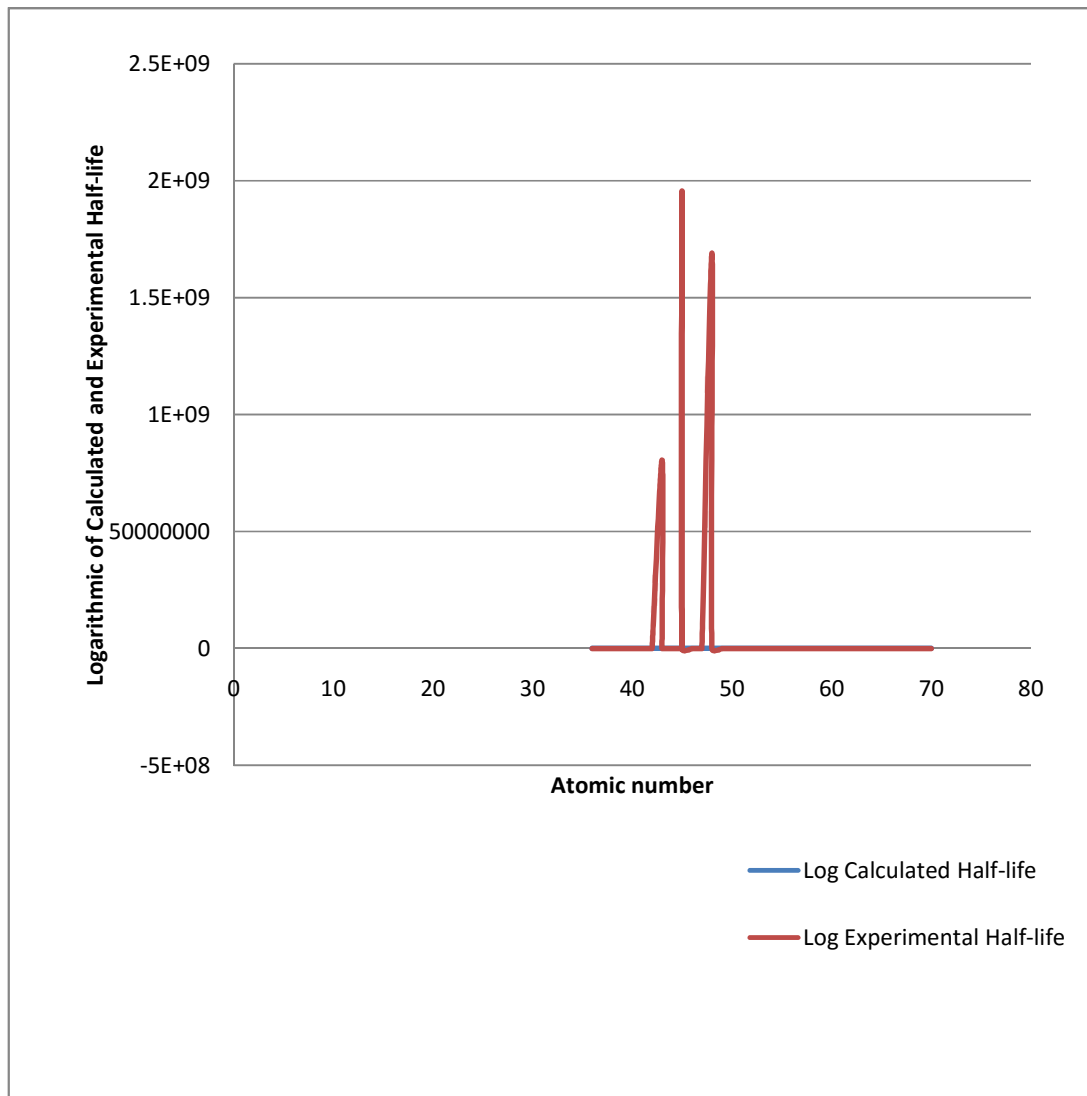

Figure 3: Logarithmic plot of Calculated and Experimental Half-lives versus Atomic Number for $^{75}_{36}\text{Kr}$ to $^{157}_{70}\text{Yb}$ mass nuclei.

Figure 3 shows the logarithmic calculated and experimental half-lives versus Mass number A for $^{75}_{36}\text{Kr}$ to $^{157}_{70}\text{Yb}$ mass nuclei respectively.

Figure 3 shows the anomaly lays with high mass number A values for the medium mass number A nuclei sustain a straight line of the value of calculated and experimental half-lives except for the three anomaly of the experimental half-lives that are high that is for the isotopes of the nuclei with mass number A = 94 to 99. These reveal that those low mass number A have a low rate of calculated and experimental half-lives while the three mass number A indicates that they have high experimental half-lives.

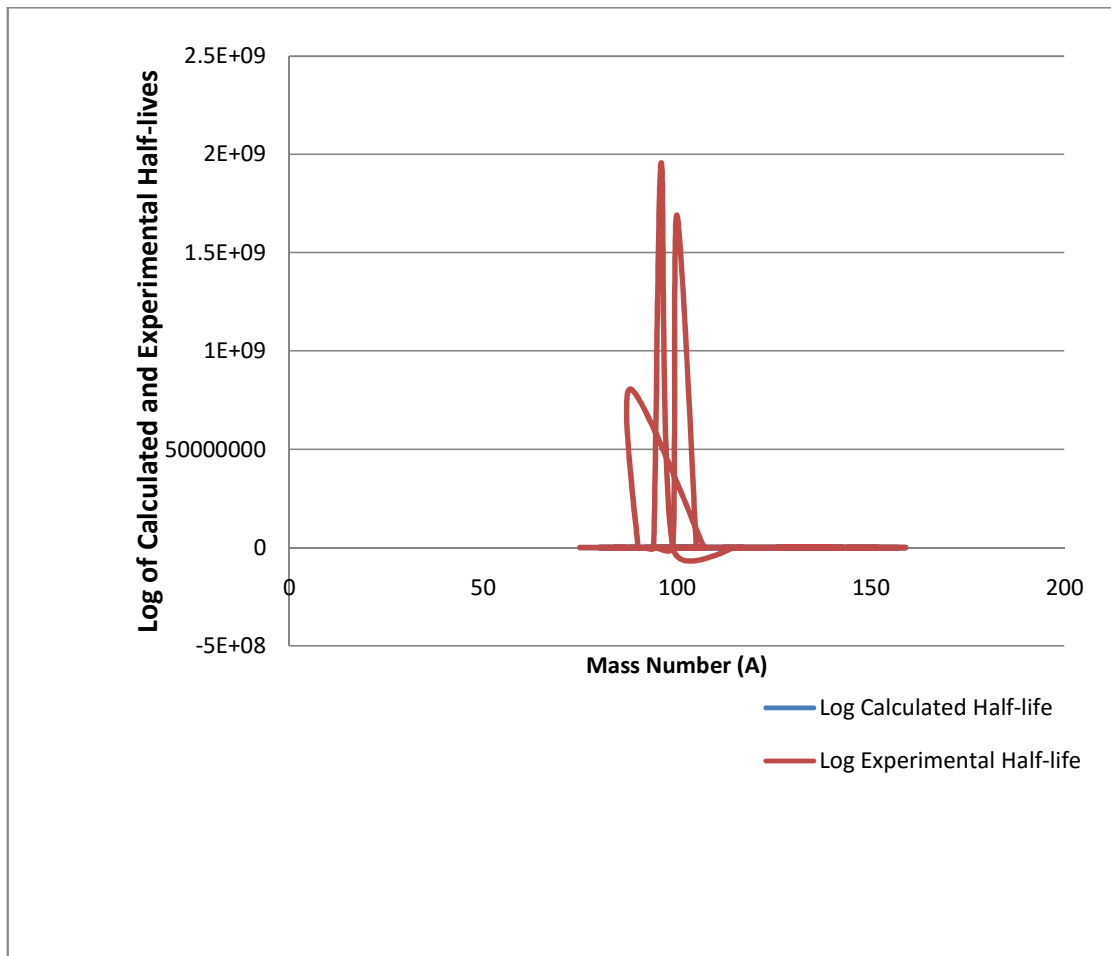

Figure 4: Logarithmic plot of Calculated and Experimental Half-lives versus Mass Number (A) of Gamma Particle for $^{75}_{36}\text{Kr}$ to $^{157}_{70}\text{Yb}$ Mass Nuclei.

Figure 4 shows the logarithm of experimental and calculated half-lives versus mass number of gamma particle for $^{75}_{36}\text{Kr}$ to $^{157}_{70}\text{Yb}$ mass nuclei. Figure 4, indicates the anomaly lies with low mass number of gamma particle values of experimental and calculated half-lives except for the three anomalies nuclei of the experimental half-lives that are high mass number of gamma particle either prove that they have high half-lives experimental as in the anomalies of the mass number of gamma particle are 90, 99 and 101.

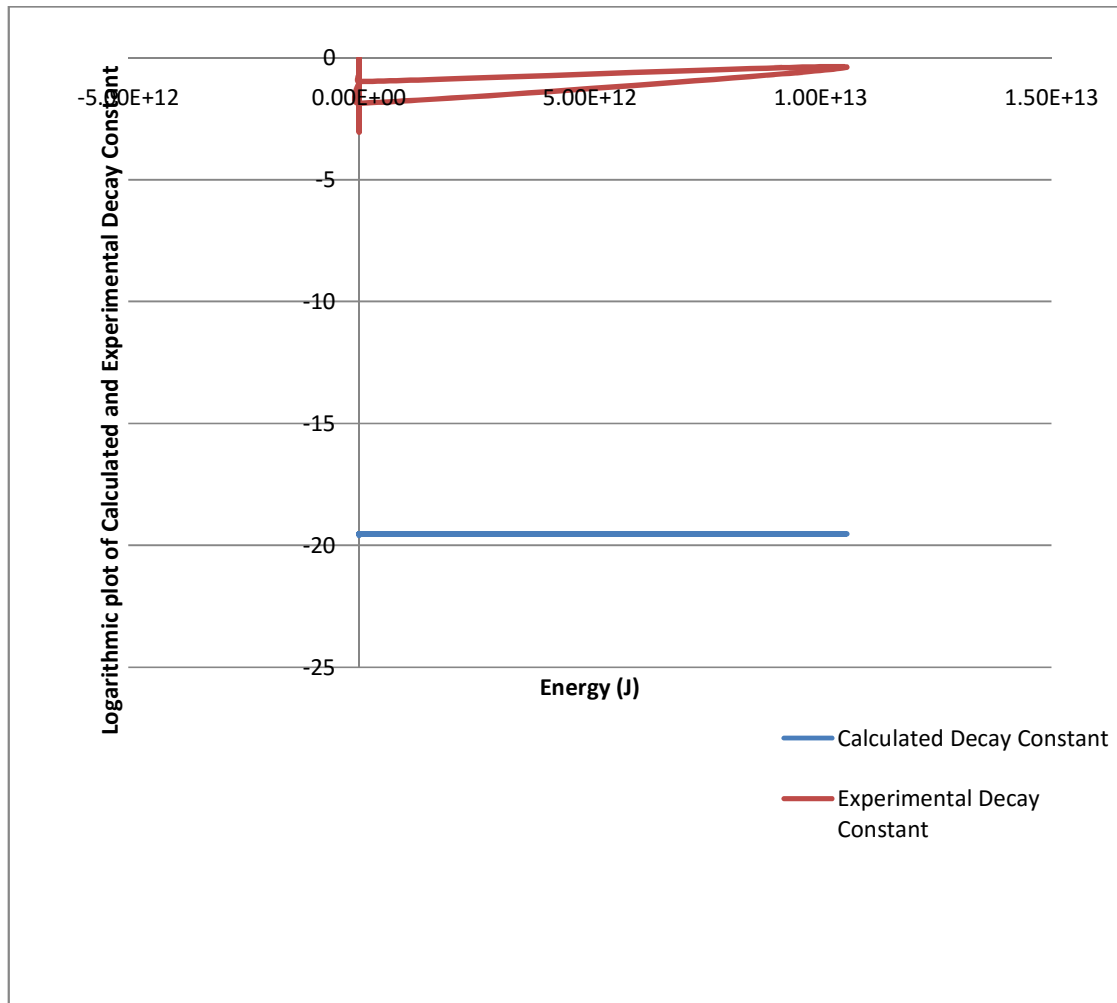

Figure 5: Logarithmic plot of Calculated and Experimental Decay constant versus Energy (J) of Gamma Particle for $^{75}_{36}\text{Kr}$ to $^{157}_{70}\text{Yb}$ Mass Nuclei.

Figure 5 represents the logarithm calculated decay constant versus Energy (J) for $^{75}_{36}\text{Kr}$ to $^{157}_{70}\text{Yb}$ mass gamma particle emitters respectively. Figure 5, the anomaly lays with low Energy (J) values for the medium gamma particles emitting nuclei. for the Energy (J) value of 0.00 is having a vertical line on the logarithm calculated decay constant from 0.00 to around -3.5 which also the figure it has a shape if cone on the position of neutral equilibrium. The cone neutral equilibrium position lies on the low Energy (J) than the order vertical line. The figure also shows a horizontal line on the Energy (J) from 0.00E+00 to 1.00E+13

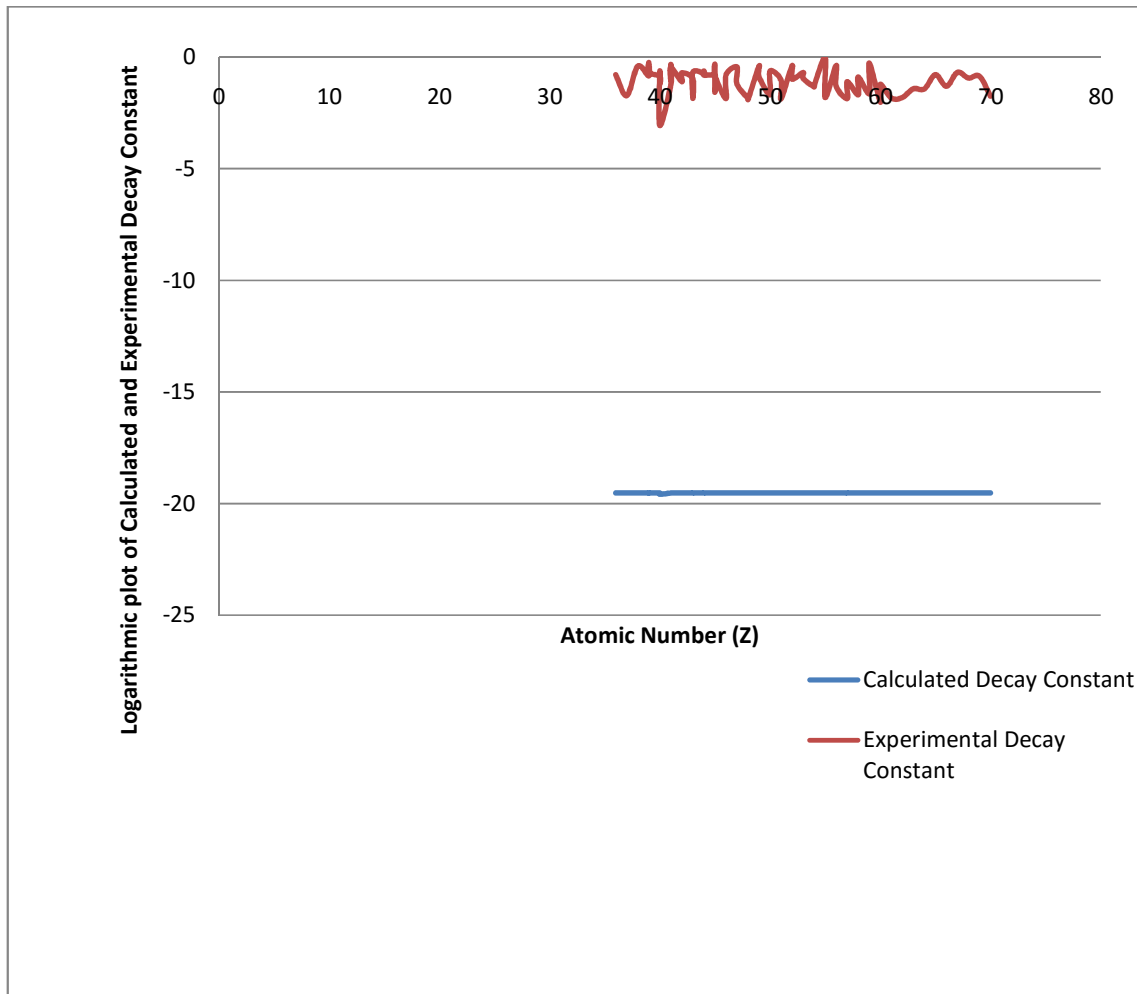

Figure 6: Logarithmic plot of Calculated and Experimental Decay constant versus Atomic Number (Z) of Gamma Particle for $^{75}_{36}\text{Kr}$ to $^{157}_{70}\text{Yb}$ Mass Nuclei.

Figure 6 shows the logarithm of calculated and experimental decay constant versus atomic number (z) of gamma particles for $^{75}_{36}\text{Kr}$ to $^{157}_{70}\text{Yb}$ mass nuclei.

Figure 6, shows the anomaly lies with low atomic number (Z) Of gamma particle values of calculated and experimental decay constant for the medium gamma particle nuclei. The figure shows a zigzag and horizontal line. For the zigzag value on atomic number (Z) = 40 has the lowest value on the zigzag while from the atomic number (Z) = 60 to 70 it diminishes.

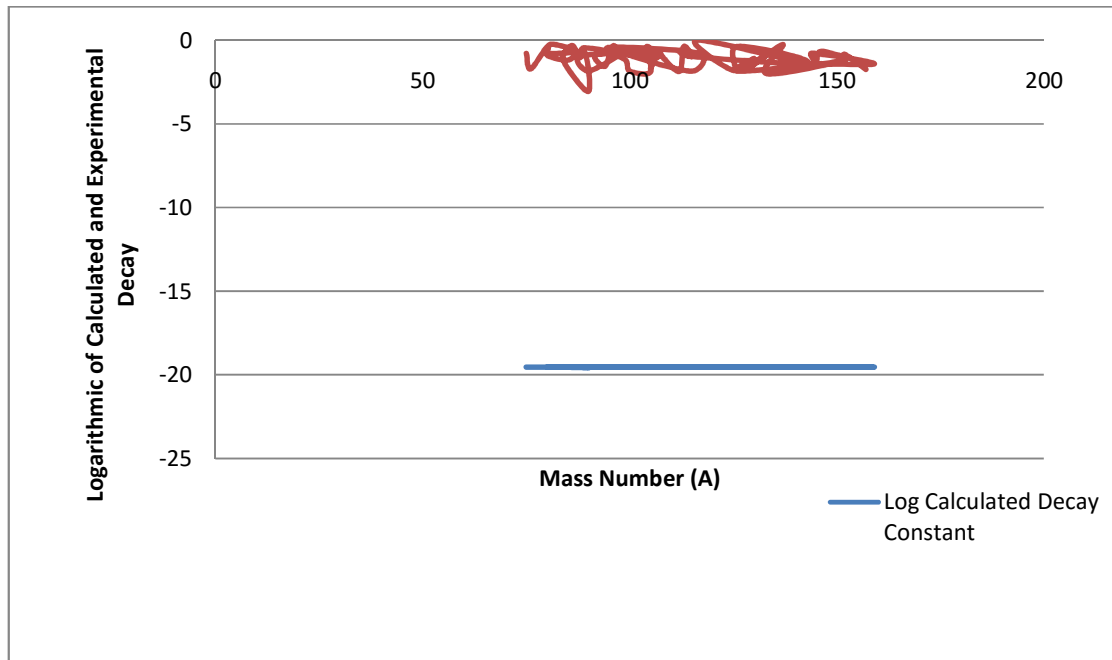

Figure 7: Logarithmic plot of Calculated and Experimental Decay constant versus Mass Number (A) of Gamma Particle for ${}_{36}^{75}\text{Kr}$ to ${}_{70}^{157}\text{Yb}$ Mass Nuclei.

Figure 7 shows the logarithm of calculated and experimental decay constant versus mass number (A) of gamma particle for ${}_{36}^{75}\text{Kr}$ to ${}_{70}^{157}\text{Yb}$ mass nuclei.

Figure 7, shows the anomaly lies with low mass number (A) values for the medium gamma particle nuclei. It shows the shapes of cones and a horizontal line. The shapes of cones are like in the position of neutral and also unstable equilibrium. The shapes lie in between mass number (A) = 71-160.

Theoretical Evaluation of Steps Approaching Zero Emission on a Double Thick Barrier of a Gamma Particle

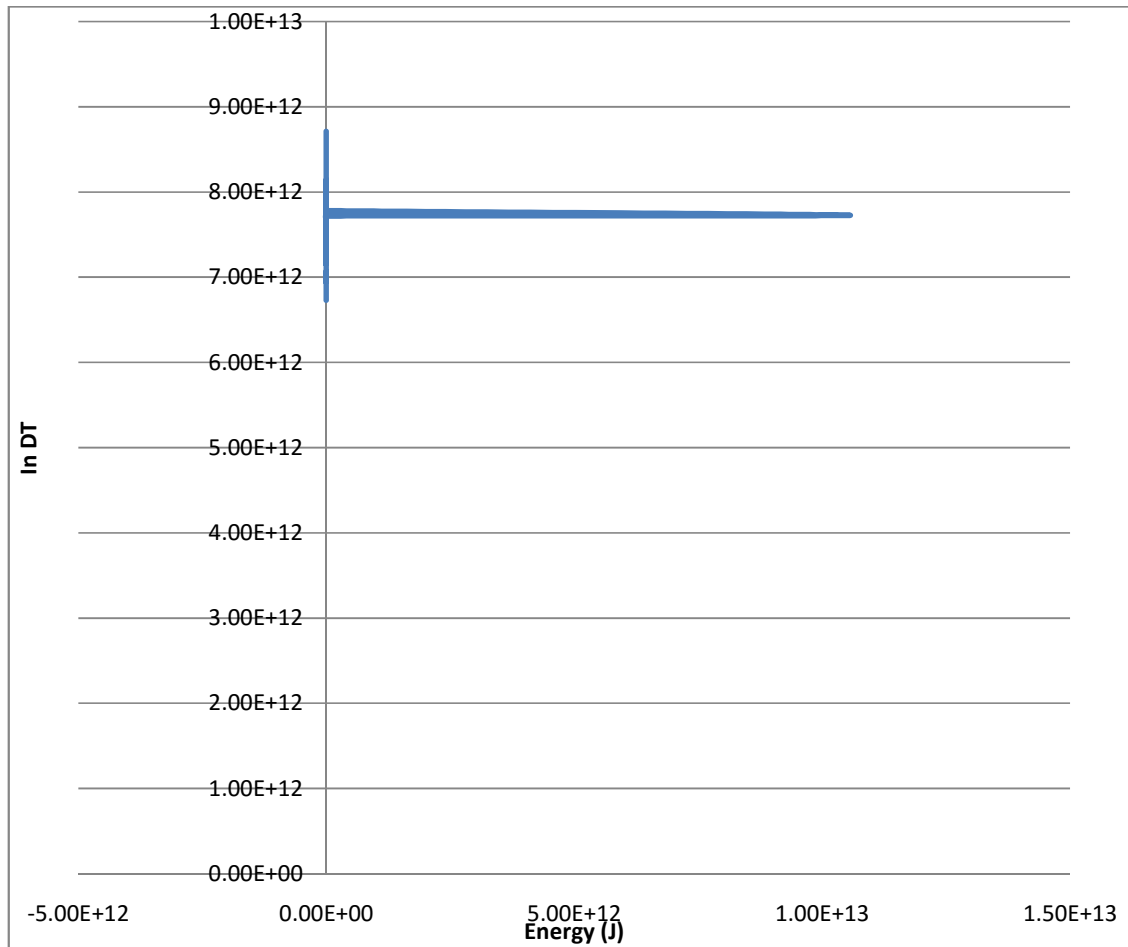

Figure 8: Natural logarithm of Tunneling probability versus Energy (J) for $^{75}_{36}\text{Kr}$ to $^{157}_{70}\text{Yb}$ Gamma Particle emitting nuclei.

Figure 8 represent the natural logarithm of tunneling probability versus Energy (J) for $^{75}_{36}\text{Kr}$ to $^{157}_{70}\text{Yb}$ mass Gamma particle emitters respectively.

Figure 8, the anomaly lie with high Energy (J) values for the medium Gamma particle emitting nuclei. From natural logarithms of tunneling probability axis that lies 0.00 E+00 on Energy (J) axis while from two different points that meet at a point that make a narrow space between the two point from the at a distance less than 5.00 E+12 Energy (J) it continuous up to a distance above 1.00 E+13. These means that the nuclides that Energy (J) to tunnel through the Double thick barrier, the Energy of the nuclides that have 0.00 E+00 lies in between a distance close to 7.00 E+12 to distance close to 9.00 E+12 and the two points are close 8.00 E+12 of the natural logarithm of the tunneling probability.

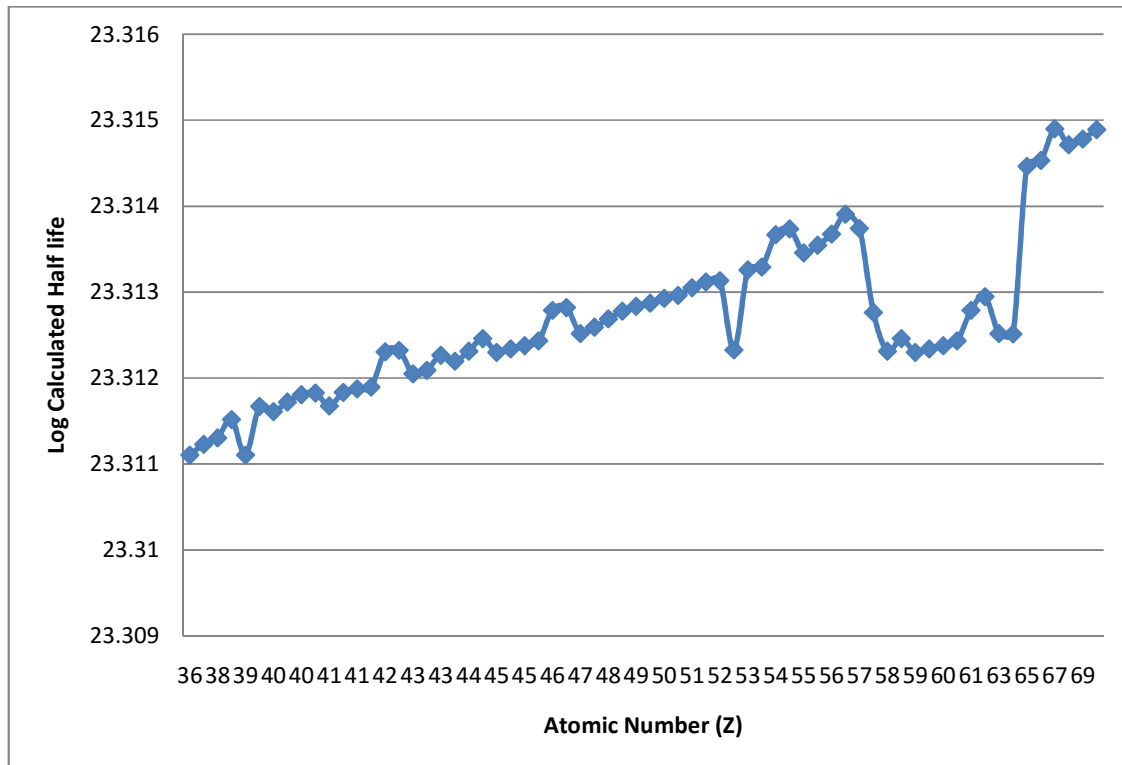

Figure 9: Logarithmic plot of Calculated Half-lives versus Atomic Number (Z) of Gamma Particle for ${}_{36}^{75}\text{Kr}$ to ${}_{70}^{157}\text{Yb}$ mass nuclei.

Figure 9 represents the logarithms of calculated half-life versus Atomic number Z for ${}_{36}^{75}\text{Kr}$ to ${}_{70}^{157}\text{Yb}$ mass Gamma particle respectively. Figure 9, the anomaly lies with high atomic number Z value for the medium gamma particle emitting nuclei. From atomic number Z = 42, 44, 46, 48, 52, 54 and 56 are slightly high than the orders also from atomic number Z = 57 to 65 makes a shape of w and from the atomic Z = 65 diminishes with increasing value of natural logarithm of tunneling probability. The reason that anomaly lies at low atomic number Z is as a result of different logarithms of calculated half-life. The shape w is as a result of a different time of tunneling to the other, that the nuclei have either very small time tunneling probability or the nuclei are stable are depicted by points lying at the bottom for each isotopes which even-even is with even-even (even number and odd proton or even proton and odd neutron) the figure shows that the time taken for the probability of gamma emission is high than even-even nuclei. The atomic number Z = 42, 44, 46, 48, 52, 54 and 56 it shows that even-even nuclei have the slit high logarithms of calculated half-life of gamma emission.

Theoretical Evaluation of Steps Approaching Zero Emission on a Double Thick Barrier of a Gamma Particle

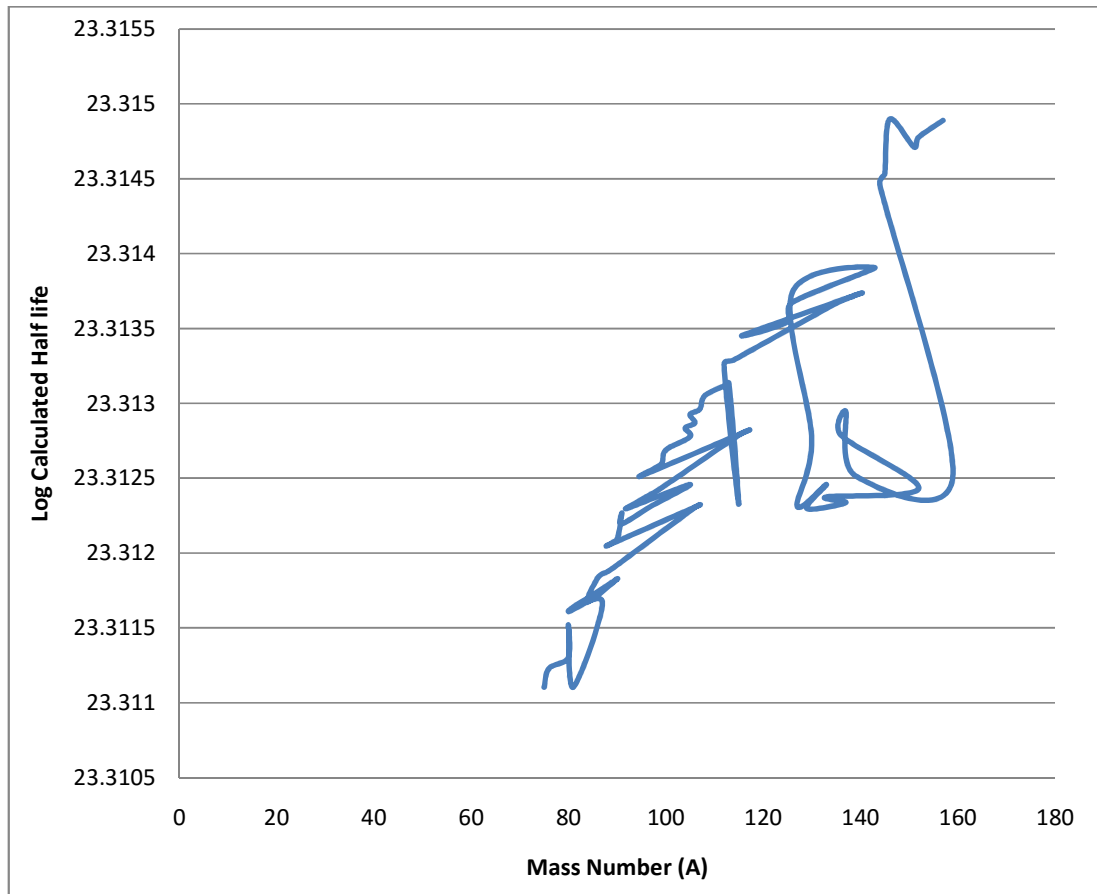

Figure 10: Logarithmic plot of Calculated Half-life versus Mass Number (A) for $^{75}_{36}\text{Kr}$ to $^{157}_{70}\text{Yb}$ mass nuclei.

Figure 10 represents the logarithms of calculated half-life versus mass number (A) for $^{75}_{36}\text{Kr}$ to $^{157}_{70}\text{Yb}$ mass Gamma particle emitters respectively.

Figure 10, the anomaly lies with high mass number (A) values for the medium gamma particle emitting nuclei. The figure shows the shape of v, zigzag shape in the ascending order and also a shape of w. The reason for the shape of v is as a result of low in logarithms of calculated half-life taken for tunneling probability, zigzag shape is as a result of different value of logarithm of calculated half-life which is not at a close distance and also shape w is as a result from one nucleus to another of the logarithm half-life for the tunneling probability.

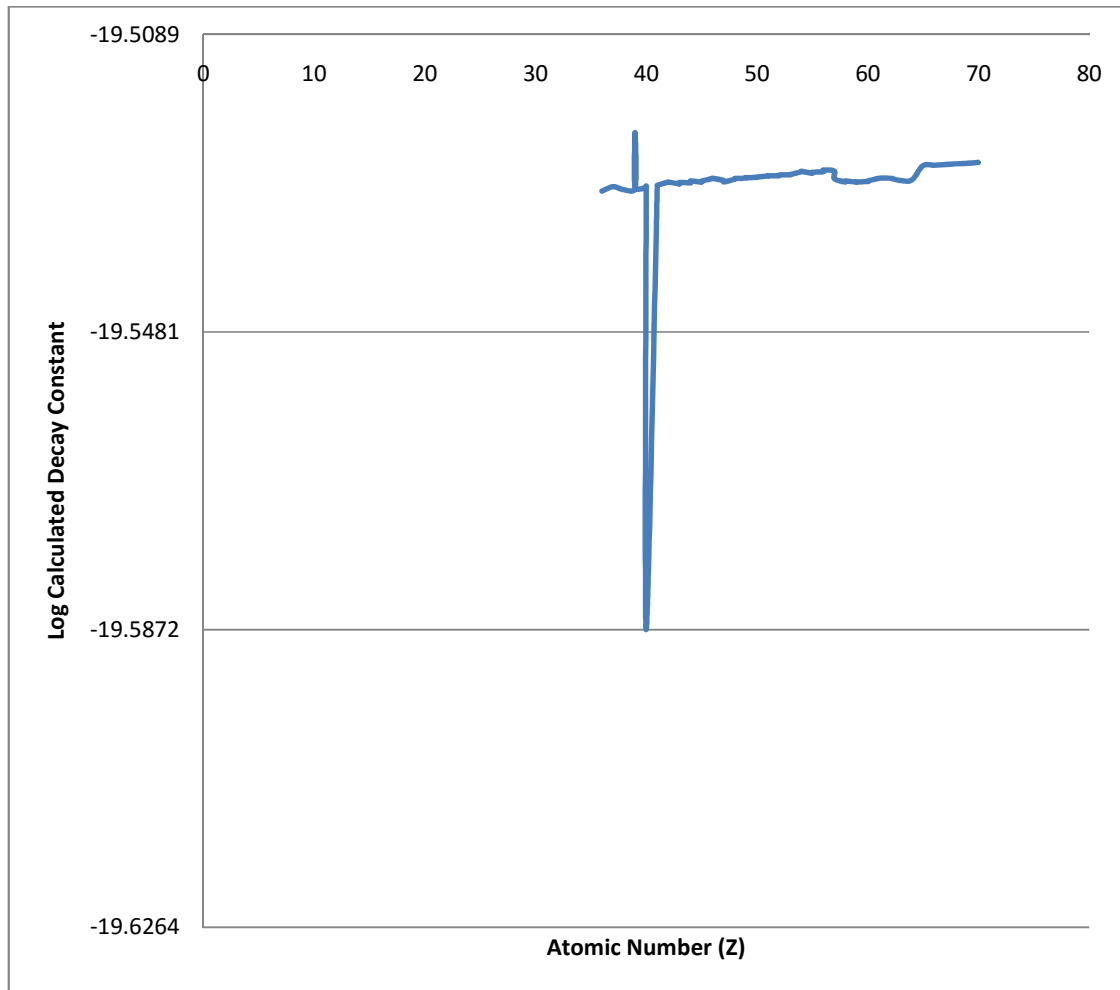

Figure 11: Logarithmic plot of Calculated Decay Constant versus Atomic Number (Z) of Gamma Particle for $^{75}_{36}\text{Kr}$ to $^{157}_{70}\text{Yb}$ mass nuclei.

Figure 11 represents the logarithms calculated Decay constant versus atomic number Z for $^{75}_{36}\text{Kr}$ to $^{157}_{70}\text{Yb}$ mass Gamma particle emitters respectively.

Figure 11, the anomaly lies with low atomic number Z values for the medium gamma particle emitting nuclei. For the atomic number Z = 39 slightly high than the orders, also for atomic number Z = 40 is lower than the orders from atomic number Z = 51 to 65 makes a shape of w and also from atomic number Z = 65 diminishes with increasing value of logarithms of calculated decay constant. This shows that atomic number Z = 39 having a high logarithms calculated decay constant than order after the tunneling probability.

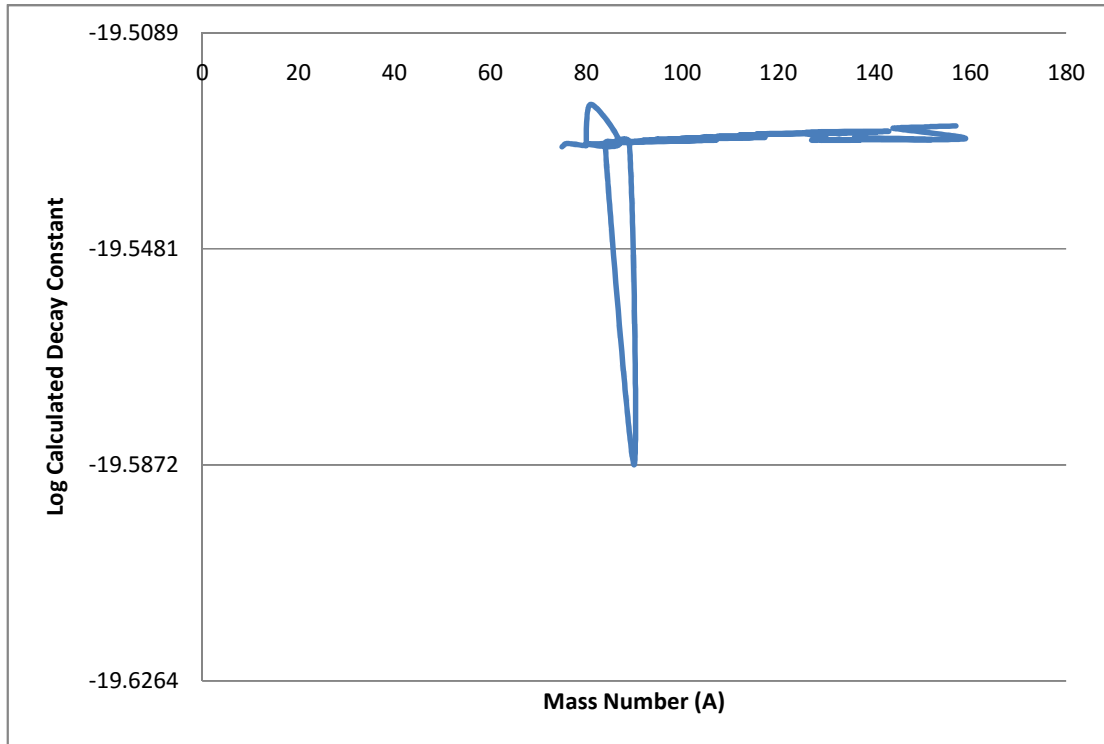

Figure 12: Logarithmic plot of Calculated Decay Constant versus Mass Number (A) of Gamma Particle for ${}^{75}_{36}\text{Kr}$ to ${}^{157}_{70}\text{Yb}$ mass nuclei.

Figure 12 represents the logarithm decay constant versus mass number (A) for ${}^{75}_{36}\text{Kr}$ to ${}^{157}_{70}\text{Yb}$ mass Gamma particle emitters respectively.

Figure 12, the anomaly lies with low mass number (A) values for the medium gamma particle nuclei. The figure shows a shape of a cone, shape of an upside down cone, closed distance zigzag and also a shape of letter S. The reason for the shape of a cone is one of the mass number (A) have lower logarithm decay constant value than the orders, for the upside down cone is as the result of the middle value of mass number (A) is having a high value of logarithm decay constant than orders, closed distance zigzag shape is as a result of fluctuation of values of logarithm decay constant at a closed distance and also for the shape of letter "S" is as a result of fluctuation of values of logarithm decay constant at a distance after the tunneling probability.

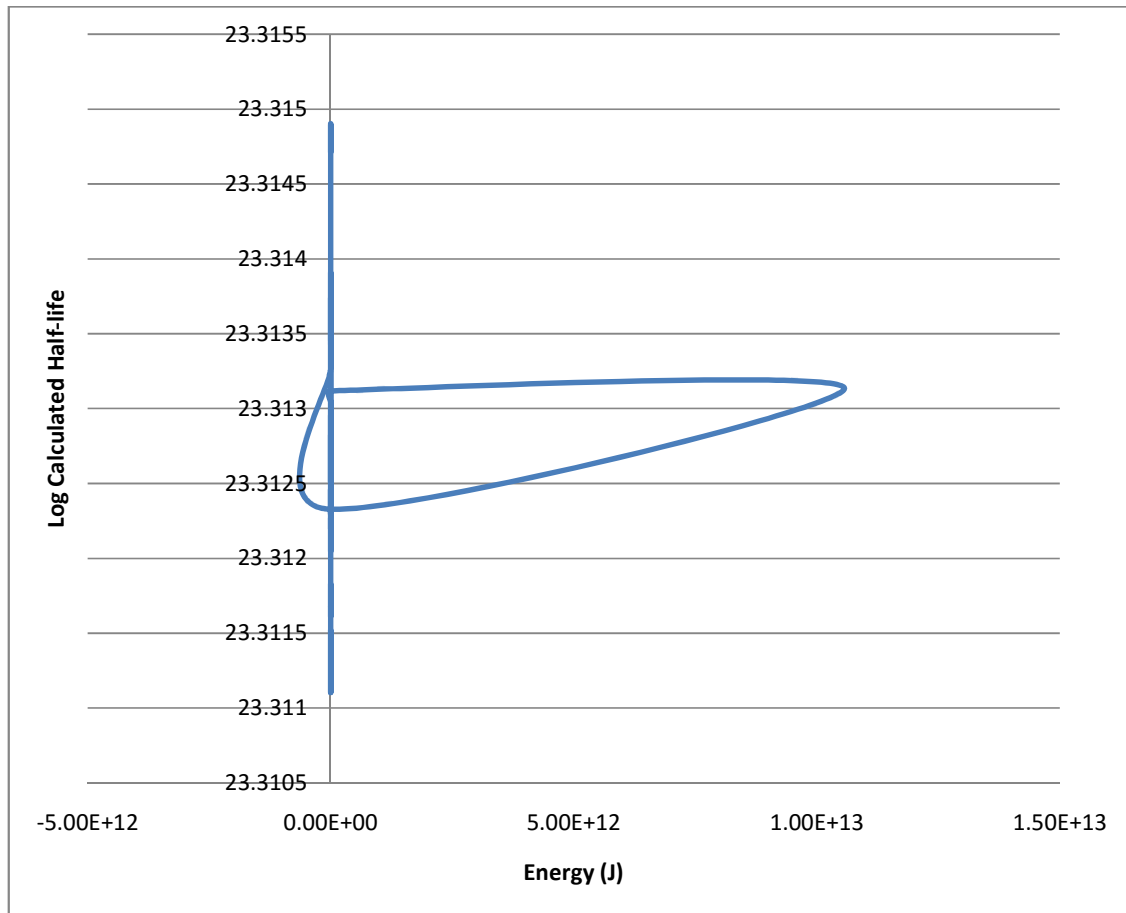

Figure 13: Logarithmic plot of Calculated Half-life versus Energy (J) of Gamma Particle for $^{75}_{36}\text{Kr}$ to $^{157}_{70}\text{Yb}$ mass nuclei.

Figure 13 represents the logarithm calculated Half-life versus Energy (J) for $^{75}_{36}\text{Kr}$ to $^{157}_{70}\text{Yb}$ mass Gamma particle emitters respectively. Figure 13, the anomaly lies with high Energy (J) values for the medium gamma particle emitting nuclei. For the Energy (J) value 0.00 E+00 is having a vertical line on the logarithm calculated half-life from above 23.311 seconds to close to 23.315 seconds and also a shape of cone on the position of neutral equilibrium. The cone neutral equilibrium position lies on the higher Energy (J) than the order vertical line. The cone lies in between close to 23.3125 seconds to above 23.313 seconds of logarithm calculated half-life that is taken to tunneling probability.

Theoretical Evaluation of Steps Approaching Zero Emission on a Double Thick Barrier of a Gamma Particle

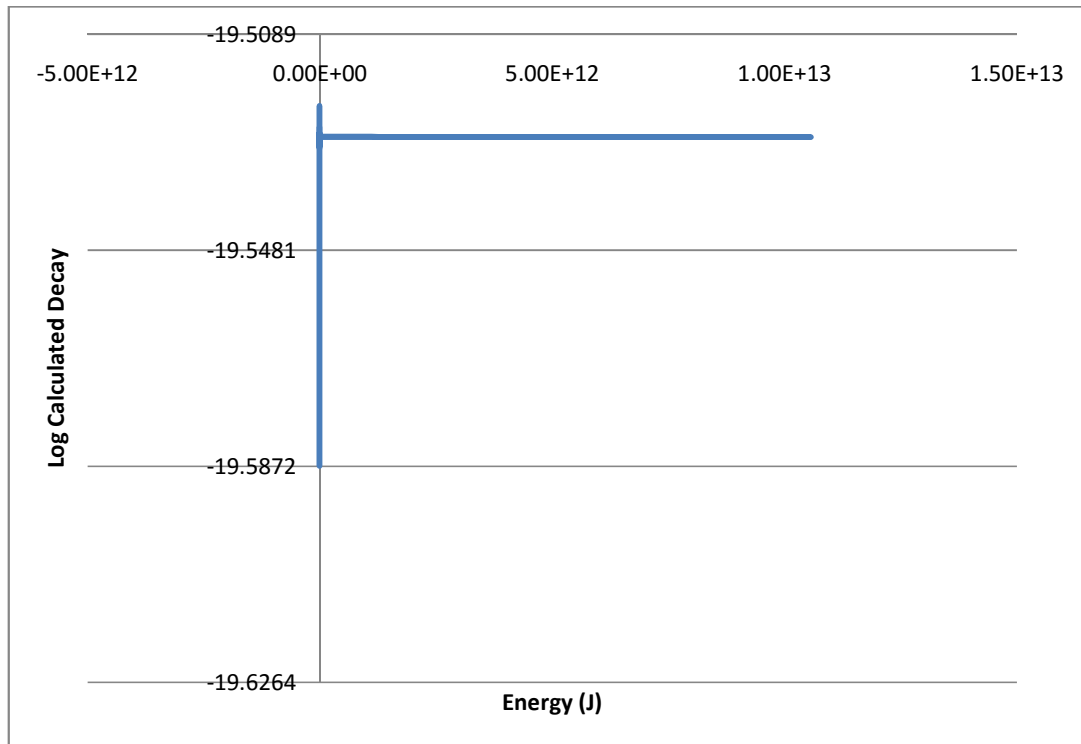

Figure 14: Logarithmic plot of Calculated Decay Constant versus Energy (J) of Gamma Particle for $^{75}_{36}\text{Kr}$ to $^{157}_{70}\text{Yb}$ mass nuclei.

Figure 14 represents the logarithm calculated decay versus Energy (J) for $^{75}_{36}\text{Kr}$ to $^{157}_{70}\text{Yb}$ mass Gamma particle emitters respectively. Figure 14, the anomaly lies with low Energy (J) values for the medium gamma particle emitting nuclei. The figure shows the vertical and horizontal lines. The values of Energy (J) at 0.00 E+00 is having vertical line on the logarithm of calculated decay which lies below -19.52 to above -19.58, the horizontal lines is as a result of the Energy (J) that have 1.00 E+13 that is after the tunneling probability.

CONCLUSION

It has been calculated analytically the quantum mechanical emission probability of barrier penetration $^{75}_{36}\text{Kr}$ to $^{157}_{70}\text{Yb}$ of the gamma particle decay of atomic nuclei. The Schrödinger's time-independent equation has been applied to a potential barrier whose height is greater than the gamma particle's energy. However, on application of barrier emission theory, the probability of the gamma particle crossing the barrier is in non-zero and this probability has been calculated.

REFERENCES

- Chaddha G. S (1983): Quantum Mechanics. Published by (India). Vol. 2nd. pp 68-72.
 Dyson F. Y (1951): Advanced Quantum Mechanics. Addison Wesley Company. Vol. 2 pp 22-23.



- Edward H. D, Baum M and Miller T. R (2002): Nuclide and Isotope. 16th edition, pp 35-29.
- Raju A.R and Anora B. L (2006): Dictionary of Physics. New Delhi. Academic (India) Publisher New Delhi; Vol.1, pp 22, 261 & 263.
- Rutherford E. (1903): The magnetic and electric deviation of the easily absorbed rays from radium. Philosophical Magazine, Series 6, vol. 5, no. 26, pages 177-187.
- Villard P (1900a): Very-High-Energy Gamma Rays from a Distant Quasar. Science. 92 (5884): 1752- 1754.
- Villard P (1900b): Evidence for a lack of DNA double- strand break repair in human cells exposed to very low x-ray doses. Proceedings of the National Academy of Science, Vol.,100 (9): 5057-62.



THE DYNAMICS OF COST OF CONSTRUCTION PROJECTS IN NIGERIA

Ojo¹, Solomon Michael, Adeniji², Wusamotu Alao, Yusuf³ Shakirudeen Olawale,

¹Department of Quantity Surveying,

²Department of Building,

³Department of Architecture

Moshood Abiola Polytechnic Ojere, Abeokuta, Ogun State, Nigeria

Emails: goodsolext1@yahoo.com

ABSTRACT

The persistent escalation of cost of both building and infrastructural projects in Nigeria is alarming. In order to improve upon the existing scenario, this study investigated and evaluated determinants of construction cost in Nigeria. The objectives of the study include: Comparative cost analysis of construction projects in Nigeria with that of some African countries, evaluation of construction cost matrix and suggestion to improve on existing scenario. Data obtained through stratified probabilistic sampling technique from 50 Nigerian Quantity Surveyors through structured questionnaire were analyzed quantitatively and the findings of the study revealed that high cost of construction materials, inflation, monopolistic market for construction materials, deliberate inflation of contract sum and kick back syndrome are major determinants of cost of construction in Nigeria. The study concluded that to curb this menace, measures outlined in the study must be implemented.

Keyword: Construction Cost, Dynamics of Cost, Nigeria, Issues, Quantity Surveyors, Ways forward.

INTRODUCTION

Successful project performance depends on some factors which include; Cost, quality and time among others. Samuel, Olatunji, Oke, Aghimien and Sakiru (2016) opined that among these three factors, cost of construction is perhaps the most significant. According to compendium report on road infrastructure & related development in Nigeria (2019) unless effectively managed cost of construction can escalate. It is a common arguable perception that cost of construction in Nigeria is far more than that of the contemporary African Countries and even beyond. Ajanlekoko (2017) however opined that it is preferable to refer to cost of construction in Nigeria as one of the highest in comparison with other countries. The notion that cost of construction in Nigeria is high compare to other countries in the world is subjective. According to Ajanlekoko (2017), there is no known empirical data base that established this assertion. But, asserts that it is safe and true to conclude that cost of construction in Nigeria is high. Even though Nigeria as a nation, has similarity in procurement methods, tendering approaches, contract types with other nations (Ogediran, Dada & Zannou, ND) asserted that it is still a prevailing perception that construction cost in Nigeria ranked among the highest in the world. Against this background, it is imperative to explore the existing scenario in Nigeria and possibly recommend implementable solutions to overcoming perceived causative factors contributing to relatively high construction cost of construction projects in Nigeria. This study investigated and evaluated determinants of construction cost in Nigeria in order to impact positively on the economy. It appears from the foregoing that, there is need to explore further on this area of concern since most submissions are based on supposition than in-depth research. Beyond the cost of construction in Nigeria, there is need to evaluate construction cost determinants in order to establish their contributions and suggest ways to ameliorate on the existing scenario. This is the focus of the study. This study covered government sponsored building and infrastructural projects in Nigeria.

STATEMENT OF THE RESEARCH PROBLEM

World Bank (2017) posited that construction is often refers to as driver of economy. Nigerian as a developing country has construction sector as key economy sector second to oil and gas sector. In the event that a nation construction industry is in a perilous state, then such a nation experience difficulty in steady growth. Findings of previous studies disclosed that the cost of construction of roads in Nigeria is alarming in comparison with other nations. Abuja Centre of Social Justice, ACSJ (2018) based on previous study conducted by World Bank (2000) reported that, constructing a kilometer of road in Nigeria cost between 400 million and over N 1 billion naira. This submission was based on specific comparison between the roads with same grade constructed in Nigeria and some African countries. The report referred to the award of 127-kilometer Lagos-Ibadan expressway at 167 billion by Federal Government of Nigeria in 2013 and similar contract of 1,028 kilometer awarded in same year between 167 billion and 240 billion by Economic Community of West African Countries (ECOWAS) as link roads between Lagos, Nigeria; Cotonou, Benin Republic; Togo; Accra, Ghana and Abidjan, Cote D'Ivoire. In essence, the number of kilometers that was covered by ECOWAS project was eight times higher than that of Lagos-Ibadan expressway and the cost per kilometer far lower than that of Nigeria. Mathematically, the maximum cost of ECOWAS road was 234 million naira, whereas that of Nigeria awarded by Federal Government was 1.3 billion naira per kilometer. What this could connote is that for every kilometer of road constructed in Nigeria at the time of this report, cost of eight kilometer could have been lost. If this trend continues, Nigeria may continue in the cycle of developing nation for many years to come instead of attaining the status of a developed country. From pre to post independence, many capital-intensive projects have been constructed and many more going and still very many yet to be constructed. These projects have been tagged to be too high in term of cost and the most popular opinion is that cost of construction in Nigeria is perceived to be the highest among its contemporary in Africa and beyond (Samuel, et al, 2016). This study therefore, tends to investigate this assertion, evaluate contributing factors and recommend ways to overcome this challenge.

RESEARCH QUESTIONS

In response to the statement of the research problem, the study postulated and answer pertinent questions which include:

- i. Is construction cost in Nigeria higher than that of the contemporary African countries?
- ii. What are the key indicators of construction cost in Nigeria?
- iii. Are there possible workable synergies to address challenges pertaining to construction cost in Nigeria?

Aim and Objectives

This study investigated and evaluated determinants of construction cost in Nigeria. The following objectives addressed the aim of the study:

- i. Comparative cost analysis of construction projects in Nigeria with that of some selected African countries;



- ii. Evaluation of construction cost matrix and
- iii. Recommend workable synergies to ameliorate high cost construction projects in Nigeria.

LITERATURE REVIEW

Construction Cost Matrix – Nigeria Scenario

According to Danso and Obeng-Ahenkora (2018) rise in price of building materials is peculiar to available in everywhere world over. Ogbuagu (2008) refers to building material as tangible items that are incorporated into construction of building or other aspects of construction and classified these as natural and artificial. Classified as natural sand, stones, wood and the artificial include tiles and paints. Predominant factor that determine construction cost is building materials (Abiola, 2000, p. 37). This account between 40–80% of construction cost (Atolagbe, 2009). Due to decline in quality of few indigenous building materials, many clients and other key players in the Nigeria construction industry prefer the imported materials which they, in most cases procured with a cost higher than that of materials manufactured locally (Adogbo & Kolo, 2009). According to Atolagbe (2009) this over dependent on foreign or imported building materials as eroded the trust many clients have for locally made materials. Emmanuel (2017) posited that building materials have significant impact on construction projects and asserted that only 10% of the reinforcement bars utilized by Nigerian construction industry annually are produced locally. Nigeria the giant of Africa as popularly refers as limited or very few manufacturers of significant building materials like cement, reinforcement bars, tiles hence the reasons for turning to importation. In identifying other factors that influence cost of construction, Ajanlekoko (2017) attributed causes of high cost of construction to funding issues. According to Samuel et al (2016) professionals' failure to carry out their statutory obligations in a diligent and responsible manners leads to unwarranted adjustments in drawings during construction, leading to high cost upshot. Inadequate cum ineffective project management skills leads to poor monitoring leading to project cost overrun as a result of rework, wasting of resources (Daniel & Anny, 2016). The perception all over the world is that the client has the money to pay for construction project and the contractor executive the project. In Nigeria, the situation is slightly different. Daniel and Anny (2016) submitted that even the prominent client, the government, is more culpable in this regard. Excessive delays and outright non payments of works executed by Nigeria government is no longer news leaving contractors no choice than to go bankrupt and, in most cases, go out of business since they often not interested in seeking a redress in court to sustain relationship. Daniel et al (2016) further observed that shoddy practices, kickback syndrome and professional negligence are also predominant causes construction cost escalation. Previous report by ACSJ (2018) disclosed that deliberate inflating Government financed projects as become hallmark in the Nigeria procurement system. Idoro (2013) posited that due to observe irregularities and cost escalation of cost of construction in Nigeria concluded Nigeria has the highest construction cost in the world. This submission appears to differ from the opinion of Ajanlekoko (2017). This study tends to feel this gap by establishing a reliable research position on the actual scenario of cost of construction in Nigeria. Aside from contributing to body of knowledge, the output of this research work would be a reference point on the true nature of construction cost in Nigeria and suggestive ways of ameliorating the existing situation.

RESEARCH DESIGN AND METHOD

The study investigated and evaluated determinants of construction cost in Nigeria. Research design adopted for the study was triangulation method. Both stratified and random probabilistic sampling technique were adopted. Nigerian Quantity Surveyors were divided into stratum according to their professional qualifications namely; Fellow, Member and Probationer. Each had an equal chance in filling the questionnaire which formed the primary data. According to Nigerian Institutes of Quantity Surveyors, NIQS (2019) directory of members, this cost experts are popularly known in Nigeria as Quantity Surveyors. The research is limited to this category of professionals because they are the custodian of construction cost (NIQS, 2020). Relevant extant literature formed the sources of secondary data. Well-structured questionnaire that address the objectives of the study was randomly distributed to 100 registered Fellows, Members and Probationers of the NIQS but was only able to retrieved 64 copies. The first objective, comparative cost analysis of construction projects in Nigeria with that of some selected African countries was achieved through cost per square meter (cost/m²) analysis of various projects across 12 countries considering their capital cities. This information was sourced from African Property and Construction Cost Guide, AECOM (2018). The study puts into consideration the peculiarity of each country considered in term currency and official exchange rate using dollar as uniform basis for comparison. Due to lack of adequate published information on comparison of cost of construction across countries, a further step was taking to validate the analysis provided by AECOM, respondents were asked through structure questionnaire to evaluate the cost of construction in Nigeria in terms of Likert's scale of (1-5) using: 5- Very high, 4- High, 3-Uncertain 2-Low, 1- Extremely low and the results were further subjected to analysis using relative importance index (RII) and results were ranked and a comparison of the assertion obtained from AECOM and other related extant literature were compared with analyzed data gathered from respondents and conclusion was drawn. To further authenticate the conclusion drawn, respondents where further asked to indicate the basis for their position. This was necessary in other to authenticate the data obtained. The second objective, evaluation of construction cost matrix was accomplished through reviewed of extant literature and analysis of data obtained from respondents through questionnaire. Beyond the construction cost indicators obtained from extant literature, respondents were asked to indicate additional factors that influence construction cost in Nigeria and evaluated them in term of level of agreement. Likert's scale of (1-5) using: (1-5) using: 5- Strongly Agree, 4- Agree, 3-Uncertain 2- Disagree, 1- Strongly Disagree was adopted and the results obtained were further subjected to analysis using relative importance index (RII) and ranking. The findings were compared with the extant literature and conclusion drawn as well. For objectives three, recommendation of workable synergies to ameliorate high cost construction projects in Nigeria. Like in objective two, some remedies to improve on construction cost in Nigeria where identified and many other remedies sourced from the respondents through questionnaire where assessed using Likert's scale of (1-5) using: (1-5) using: 5- Strongly Agree, 4- Agree, 3-Uncertain 2- Disagree, 1- Strongly Disagree. The formula for RII as submitted by Ojo (2017) is as follow:

$$\text{Relative Importance Index (RII)} = \frac{\text{Sum of weights } (w_1 + w_2 + w_3 + w_4 + w_5)}{(A \times N)}$$



Where w is the weighting given to each variable by the respondents, ranging from 1 to 5. A is the highest weight (i.e 5) in the study; and N is the total number of samples

DATA COLLECTION, ANALYSIS AND DISCUSSION OF FINDINGS

Data Collection

Table 1.0: Questionnaire Administration

Distributed	Expected	Retrieved	Properly filled	Used for analysis
100	80	54	50	50

Source: Field Survey, 2019

Background of the Respondents

Table 1.1: Demography of the Respondents

Academic Qualification	Frequency	Percentage
PhD	9	18
Master	19	38
Bsc/BTech	12	24
HND	10	20
Professional Qualification		
	Frequency	Percentage
Fellow	6	12
Member	34	68
Probationer	10	20
Years of Experience		
	Frequency	Percentage
Less than 5years	8	16
5 – 10years	18	36
11 – 15years	11	22
16 – 20years	5	10
Above 20years	8	16
Total	50	100

Source: Field Survey, 2019

The combination of academic, professional qualifications and years of experience of the categories of the sample reinforces the reliability of the data collected and analyzed. Among the Quantity Surveyors, 28 of them which is more than 50% of the entire sample had more than 1st degree as they constituted the majority with practical experience above 10years. Fellow and members of the Nigerian Institute of Quantity Surveyors (NIQS) combined, formed 80% of the respondents. Against this background, the results of this research are factual and reliable in conjunction with reliable extant literature.

Cost of Construction Projects in Nigeria and Some Selected African Countries

Table 1.2: Cost of Construction in Nigeria – The Nigerian Quantity Surveyors' Perception

Quantity Surveyors' Responses	Categories of Respondents			
	(Fellows)	(Members)	(Probationers)	R NR
High	3	18	4	1 st 26

The Dynamics of Cost of Construction Projects in Nigeria

Very High	3	12	4	2 nd	19
Moderate	0	2	2	3 rd	4
Low	0	0	0	0	4 th
Extremely low	0	0	0	4 th	0

Source: Field Survey, 2019

Key: RI=Relative Importance Index, R=Ranking, NR=Number of Respondents

Table 1.3: Nigerian Quantity Surveyors Basis for Submission of Cost of Construction in Nigeria

Quantity Surveyors' Responses	(NR)	(Percentage)	Ranking
Practice	41	82	1 st
Published Research article	4	8	2 nd
Newspaper article	3	6	3 rd
Personal opinion	2	4	4 th

Source: Field Survey, 2019

Key: NR=Number of Respondents



Table 1.4: Cost of Construction Projects in Nigeria and other African Countries Compared

African Countries Average)	Overall Average Cost of Construction/Square Meter in US Dollars (Ranking)	(Total
Nigeria (Lagos)	2,629	1 st
Angola (Luanda)	2,626	2 nd
Senegal (Dakar)	1,772	3 rd
Ghana (Accra)	1,660	4 th
Rwanda (Kigali)	1,600	5 th
Botswana (Gaborone)	1,372	6 th
Mozambique (Maputo)	1,319	7 th
Uganda (Kampala)	1,190	8 th
Zambia (Lusaka)	1,183	9 th
Kenya (Nairobi)	1,053	10 th
Tanzania (Dar es Salaam)	997	11 th
South Africa (Johannesburg)	971	12 th

Source: African Property & Construction Cost Guide (2018)

Tables 1.2, 1.3 and 1.4 show the view of Nigerian Quantity Surveyors on the cost of construction projects in Nigeria and the basis for their various submissions and the scenario in some selected African countries. The projects considered basically were government financed projects which include buildings and infrastructural facilities which was not limited to roads construction. The basis for limiting the research to corporate project is the ease of tracking of the cost record in comparison with the private sector. Conclusion drawn from the tables was that, most of the Quantity Surveyors that responded to the questionnaire practice as consultants which afforded them the opportunity to track the cost of projects from inception to practical completion. Most of them also extend their practice beyond Nigeria border which gave them additional opportunity to have compared cost of construction in Nigeria with other African countries. From their submission, most opined that cost of construction projects in is high compared to other African countries that the study covered. An investigation was also carried out to validate the position of Nigerian Quantity Surveyors by computing the cost per square meter of different projects across some selected African countries as deduced from African Property & Construction Cost Guide, APCCG, (2018) as indicated in Table 1.3. Though the basis of comparison was same, it also has its limitations as there could be inter border factors that could influence cost of construction in various countries such as warfare and so on (Rebosio & Wam, 2011). To further strengthen the reliability of published data from APCCG, the report from World Bank (2018) on comparison of cost construction across nations even beyond Africa countries further reinforced the research findings.

Evaluation of Construction Cost Matrix in Nigeria

Table 1.5: Construction Cost Matrix Nigeria Scenario

Significant Construction Cost Indicator(s)	SA	A	U	D	SD	RII	R	NR
	(6)	(5)	(4)	(3)	(2)	(1)		

The Dynamics of Cost of Construction Projects in Nigeria

High cost of construction materials	34	13	2	0	0	0.94	1 st	50	
Inflation		19	21	8	2	0	0.89	2 nd 50	
Monopolistic market for construction materials	22	22	4	2	0	0.86	3 rd	50	
Deliberate inflation of contract sum		12	25	9	4	0	0.86	4 th 50	
Kick back syndrome		21	16	13	0	0	0.83	5 th 50	
Shoddy practice		21	18	9	2	0	0.83	5 th 50	
Difficulty in accessing loan by contractor	19	21	8	2	0	0.83	5 th	50	
Delay in execution of construction projects	16	26	6	2	0	0.82	8 th	50	
Over dependent of imported materials		27	19	3	1	0	0.82	8 th 50	
Professional Negligence		21	21	8	0	0	0.78	10 th 50	
Unwarranted upward review of contract sum	17	25	9	1	0	0.78	10 th	50	
Construction method		13	15	16	6	0	0.74	12 th	50

Source: Field Survey, 2019

Key: SA=Strongly Agree, A=Agree, U=Uncertain,
D=Disagree, SD=Strongly Disagree,

RII=Relative Importance Index, R=Ranking, NR=Number of Respondents

It appears from table 1.5 that besides high cost of construction materials and inflation that were ranked 1st and 2nd respectively that are economically influenced other factors that influence construction costs in Nigeria are humanly or systemically motivated. Government policy and unfriendly or non-conducive business environment for investors to explore and establish industry or companies has resulted to monopolistic market condition which translates to periodic high cost of construction materials even when inflation rates reduces. Putting construction cost in Nigeria under check is a possibility that is attainable as indicated in factors 4 – 6 on table 1.5.

Probable Synergies to Address Issues Pertaining to Construction Cost in Nigeria.

Table 1.6: Probable Construction Cost Escalator Arresters in Nigeria

Construction Cost Escalator Arresters	SA	A	U	D	SD	RII	R	NR		
						(5)	(4)	(3)	(2)	(1)
Engage only certified and qualified cost experts	33	14	3	0	0	0.92	1 st	50		
Elimination of monopolistic market		29	17	3	1	0	0.90	2 nd	50	
Government should form omnibus entity		29	16	5	0	0	0.90	2 nd	50	
Government should formulate working policies	28	19	3	0	0	0.90	2 nd	50		



Eliminate delays in execution of projects	27	21	2	0	0	0.90	2 nd	50
Loan should be easy to access	27	17	5	1	0	0.88	6 th	50
Government should establish factories	28	15	3	3	1	0.86	7 th	50

Source: Field Survey, 2019

Key: SA=Strongly Agree, A=Agree, U=Uncertain D=Disagree,
 SD=Strongly Disagree,

RII=Relative Importance Index, R=Ranking, NR=Number of Respondents

Engaging only certified and qualified cost experts was identified by the Quantity Surveyors as the most important of all remedies to curb skyrocketing cost of construction projects in Nigeria. It is fundamental to note that erroneous estimation is a product of quackery misleading the clients. It is a common established perception that correct and reliable estimate at pre, construction and post construction stages is a tool for accurate cost forecasting. Elimination of monopolistic market was rated 2nd with government should form omnibus entity, Government should formulate working policies and eliminate delays in execution of projects.

DISCUSSION OF FINDINGS

Cost of Construction Projects in Nigeria

The findings of the research indicate that the common position of the Nigerian cost experts is that cost of construction project in Nigeria is high as indicated in table 1.3. This inference is in consonant with previous submissions of Ajanlekoko (2017) and Oyediran et al (ND) both asserted that cost of construction in Nigeria are relatively high, though acknowledged that there is inadequate research works to substantiate this popular perception. The findings of this work differ from the submission of Idoro (2013) that opined that cost of construction in Nigeria is the highest in the world. The results of this study add to knowledge in this area of concern and could provide remedies to curb escalating cost of construction in Nigeria. The findings of this study provided the intuition for the researcher to compare the construction cost/m² in Nigeria with that of some African countries, the factors that significantly influence cost of construction in Nigeria and how the situation can be put under check through some control measures.

Comparative Cost Analysis of Construction Projects in Nigeria with that of other African Countries.

An x – ray of the research carried out on cost per square meter (cost/m²) of various building types by African Property and Construction Cost Guide, AECOM (2018) covering the mega/capital cities in 12 African countries as indicated in table 1.4 revealed that Nigeria has the highest cost of construction per square meter. The cost/m² of different types of constructions projects were covered by AECOM through their offices in each considered African countries through well trained and experienced construction cost experts. The approach was that, cost/m² was obtained from these countries using their currency and the results were converted to US Dollar to form a uniform basic for cost comparison. The construction projects covered included; residential, commercial, hotel and industrial and the overall average obtained and ranked. Because of the perceived limitations of this approach, to validate or

investigate this submission, Nigerian construction experts of different categories (fellows, members and probationers) were asked to indicate their views of construction cost of projects in Nigeria in the scale of extremely high (5), high (5), uncertain (3), low (2) and extremely low (1) as indicated in table 1.2. Their submission is in agreement with that of AECOM. However, World Bank report as submitted by Rebosio et al (2011) and Turner and Townsend (2018) highlighted the set back of the approach adopted by AECOM and submitted that, any change in the exchange rate makes a huge difference; if a particular currency is strong compared to the base currency, the cost of construction appears to be expensive. It was recommended that a more reliable approach of comparing the cost of construction across countries is using the purchasing power parity (PPP). The supposed advantage of this method is that it leaves exchange rate out of the equation with a caveat that a global firm looking to build overseas, it can be more convenient to look at cost in its home currency.

Evaluation of Construction Cost Matrix

Predominant among factors significantly influencing cost of construction projects in Nigeria are high cost of construction materials (Ranked 1st, RII = 0.94) followed by Inflation (ranked 2nd, RII = 0.89), monopolistic market for construction materials (ranked 3rd, 0.86) and deliberate inflation of contract sum (ranked 4th, 0.85) followed by other factors in the order of importance as indicated in table 1.3. Similar study conducted by Danso and Obeng-Ahenkora (2018) in Ghana, identified cost of construction materials and followed by excessive reliance on imported materials for construction as significant factors that contributes to escalation of cost of construction. Even with different respondents and countries, cost of construction materials tends to be the most significant factor that propelled high cost of construction. This finding mirrors the submission of Emmanuel (2017) that posited that among all factors that contribute to cost of construction, the cost of building materials appears to be the most significant of all.

Synergies to Address Issues Pertaining to Construction Cost in Nigeria.

The findings of this research disclosed that engaging only certified and qualified cost experts , elimination of monopolistic market, formation of omnibus entity whose mandate is to investigate and prosecute construction contract players misdeed by government, formulation of working policies by government, elimination of delays in execution of projects, easy access to loan for contractors and establishment of factories that manufacture construction materials both by government and private investors could address high cost of construction in Nigeria. The findings of this study agree with the submission of Ajanlekoko (2017).

CONCLUSION

The study therefore concludes that the construction cost of projects in Nigeria is high in comparison with contemporary African countries. Significant factors responsible for this are: High cost of construction materials, Inflation, Monopolistic market for construction materials, deliberate inflation of contract sum, Kick back syndrome, Shoddy practice, Difficulty in accessing loan by contractor, delay in



execution of construction projects, Over dependent of imported materials, Professional Negligence, unwarranted upward review of contract sum and construction method. To curb this menace, the study submits that only certified and qualified cost experts, elimination of monopolistic market, formation of omnibus entity, formulation of working policies and elimination of delays in execution of projects by government by removal of bottle neck in process in payments of contractors.

RECOMMENDATIONS

The study recommends that:

- i. Cost of construction can be minimized in Nigeria by eliminating monopoly in the manufacturing industry thereby encouraging many investors to invest and promote healthy competition like telecommunication industry
- ii. Formation of Omnibus government entity to regulate the activities of construction activities is long overdue. The existing Bureau of public procurement seems not to be enough to address high cost of construction in Nigeria and
- iii. All stakeholders in the Nigerian construction industry should learn and adopt the ways of other nations whose cost of construction are relatively low.

REFERENCES

- Abiola, R.O. (2000), Management Implications of Trends in the Construction Cost in Nigeria from 1989-1999. *The Quantity Surveyor*, 1(30), 35-40.
- Abuja-based Centre for Social Justice Report (2018): *Is Nigeria the Costliest Place Roads in the World?*
- Adogbo, K.J. and Kolo, B.A. (2009), "The Perceptions on the use of Indigenous Building Materials by professionals in the Nigeria Building Industry", *Journal of Construction Technology*, 3, 1-4.
- Ajanlekoko, J.O. (2017, August 4). *Why Construction Cost Remains High in Nigeria*. The Property.
- Atolagbe, A.M. (2009), "The third world option in a globalized Building Materials Market: The Nigeria case study", *Ethiopian Journal of Environmental Studies and Management*, 2(21), 84-91.
- Compendium Report on Road Infrastructure & Related Development in Nigeria: Retrieved on the 30th of December, 2019, from: www.works.gov.ng
- Daniel, C. O. and Anny, N. A. (2016), "Causes of High Costs of Construction In Nigeria" *Journal of Construction Engineering and Management* · June 1988 DOI: 10.1061/(ASCE)0733-9364(1988)114:2(233)
- Danso, H. and Obeng-Ahenkora, N.K. (2018), Major Determinants of Prices Increase of Building Materials on Ghanaian Construction Market. *Open Journal of Civil Engineering*, 8, 142-154. <https://doi.org/10.4236/ojce.2018.82012>
- Emmanuel, A. (2017, July 30). *4 Factors Affecting Cost of Building Construction in Nigeria*. The Information Guide in Nigeria.
- Idoro, G. (2013). *Economic Transformation Through Infrastructural Development: The Role of Project Management*, Department's 9th Annual Project Management Lecture.
- International Construction Market Survey (2018): Turner and Townsend.
- Nigerian Institute of Quantity Surveyors' Directory of Members (2019) edition.

- Nigerian Institute of Quantity Surveyors' Directory of Members (2020) edition.
- Ogbuagu, O.G. (2008), *Structural Design of a Duplex Using Theorem of Three Moments Method of Structural Analysis* (Unpublished B.Sc thesis), Department of Building, Abia State University, Uturu, Nigeria.
- OJO, S. M. (2017). *Use of Dispute Resolution Methodology among the Quantity Surveyors in the Nigerian Construction Industry; an Msc Dissertation Submitted to the Department of Quantity Surveying, University of Lagos in fulfillment of an Award of Msc in Quantity Surveying (ND)*.
- Oyediran .O.S., Dada. M.O and Zannou. S.D.H. (ND). *Comparison of Some Aspects of the Construction Industry of Nigeria and the Republic of Benin*.
- Rebosio, M. and P. E. Wam (2011). *Violent conflict and the road sector: Points of interaction*. Technical report, The World Bank.
- Samuel, O., Olatunji, A.E., Oke, D. O., Aghimien, S and S. A. (2016), "Effect of Construction Project Performance on Economic development of Nigeria" *Journal of Economics and Sustainable Development: ISSN 2222-1700 (Paper) ISSN 2222-2866 (Online), Vol.7, No.12, 2016*.



THE ROLES OF HIGH AND LOW ALTITUDES TRAINING ON SPORT PERFORMANCE AMONG TRAINED ATHLETES: A CONCISE REVIEW

Williams, Eke Jacintha; Mohammed, Idris Jika; Abdul, Mohammed Sunday, Jonathan & Dahiru, Abdullahi Danasabe
Department of Human Kinetics and Health Education
Ibrahim Badamasi Babangida University, Lapai, Niger State, Nigeria
Email: danasabedahiru39@gmail.com

ABSTRACT

The effects of altitude (high and low land) on sport performance cannot be overemphasized. This paper reviewed some physiological parameters resulting from altitude training as it affects sport performance among athletes. The paper highlighted that when athletes are exposed to high altitude training there will be an early failure of the respiratory system in response to hypoxia which was perfected by responses in the blood and the cardiovascular system signifying physiological effect of acclimatization. The paper also found that in the ventilation and gas exchange, respiration of both external and internal leads to delivery of oxygen to tissue from atmosphere. It was also highlighted in the paper that there is water loss and decrease in plasma volume which is associated with dry environment and hyperventilation, and the movement of fluid from the intravascular space into the interstitial and intracellular spaces. The review also explained that at high altitude, there is an increase in the metabolic stress and the cellular disturbance in the skeletal muscle. The vital adaptive response to altitude training is a switch from oxidative phosphorylation to anaerobic glycolysis in the energy metabolism and lastly the altitude challenge are some possible consequences or sicknesses an individual or athlete may encounter at high-altitude such as acute mountain sickness (AMS), high-altitude pulmonary edema (HAPE) or high-altitude cerebral edema (HACE). The researcher suggested that, when traveling to high altitude there are preventative measures that can be taken in order to avoid the development of any high altitude sicknesses such as; a slow ascent, pre-acclimatization, avoid moderate exercise within the first two days at altitude, drinking plenty of water, eating an adequate amount, and obtain sufficient sleep.

INTRODUCTION

Mountains are defined as landforms higher than 600 meters as a consequence of the increased altitude, the barometric pressure falls and the environmental partial pressure of inspired oxygen decreases, with consequent ambient hypoxia. This, in combination of low temperature, low humidity, increased solar radiations and presence of wind in association with strong physical activities, imposes the human body important physiological adaptations affecting primarily the cardiovascular and respiratory systems. Physical modifications begin to be significant over 2500 meters. In normal subjects, the variability of this response may be very high and generally it is well tolerated. On the contrary, these adjustments may induce major problems in patients with preexisting cardiovascular diseases in which the functional reserves are already limited (Naeije, 2010).

A high altitude atmosphere produces functional stress in humans. The changes can occur at moderate altitude, between 2,000 and 3,000 m; and high altitude, above 3,000m (Bärtsch, Saltin & Dvorak 2008; Frisancho, 1993). The main factors to this stress are: hypoxia, high solar radiation, low temperature, low humidity, high winds, limited nutritional base and rough terrain (Frisancho 1993). But the most significant is hypoxia, since the others could be existing in different environmental

zones. Hypoxia is defined as a decrease in the oxygen supply to a level insufficient to maintain cellular function (Zauner, Daugherty, Bullock & Warner 2002).

In the life of aerobic organisms, oxygen is a vital element. The fundamental role of oxygen is due to the fact that it is the final acceptor of electrons in the mitochondrial respiratory chain. This allows the ultimate process of oxidative phosphorylation and the generation of cellular energy, in the form of adenosine triphosphate (ATP). ATP is used in most reactions that are necessary to maintain cellular viability. Under normoxia a cell continuously maintains a high and constant ratio of cellular ATP/ADP ratio in order to survive.

The dependence of cells on a high constant ATP/ADP ratio means a dependence on oxygen. Therefore, a reduction of the normal oxygen supply (hypoxia) will have consequences on the cell viability (Lopez-Barneo, Pardo & Ortega-Saenz 2001; Hardie, 2003). Additionally, hypoxia response can be divided in different time scales, including an acute, an intermediate and a chronic response, and in different levels of oxygen concentration, including a moderate (5-8% O₂) and an anoxic level (<1 O₂) (normoxia 21% O₂) (Brahimi-Horn & Pouyssegu 2007; Toescu 2004; Lee, Roth & LaFres 2007). The brain is regarded as the most hypoxia-sensitive organ because of its high oxygen supply, whereas the skeletal system is the most hypoxia-tolerant (Boutilier 2001).

An increase in altitude leads to a proportional fall in the barometric pressure (atmospheric pressure, the pressure on sea level that is caused by the weight of air above sea level), and to a decrease in the pressure of atmospheric oxygen. This produces hypobaric hypoxia (a situation in which the body is deprived of adequate O₂ supply from the air to the body tissue whether in quantity or molecule concentration) that affects, in different degrees, all body organs, systems and functions (Frisancho 1993; West 2005). At high altitude, the body has to develop some adaptations and changes that allows the oxygen transport system to compensate for the hypoxia in order to maintain an adequate tissue oxygen level to support metabolism (Hurtado 1971). The high altitude inhabitant has adapted to the hypoxic environment to improve oxygen delivery and oxygen utilization, by modifying the respiratory, cardiovascular and metabolic systems (Frisancho 1993; Hurtado 1971). It can be scientifically proven whether this level of functional adaptations is inherited, or acquired during growth and development. There is little doubt that being born and raised at altitude leads to a series of metabolic, musculoskeletal and cardio-respiratory adaptations to environmental hypoxia that influence oxygen transport and its utilization. Nevertheless, there is no consensus as to how these changes affect exercise capacity and physical activity of people who live and train at moderate or high altitude, it has been reasoned that exercising in hypoxia could increase the training stimulus (Bailey & Davies, 1997). So, after exposure to altitude, performance at sea level (SL) might be improved owed to the physiological adaptations (Vogt & Hoppeler, 2010).

Many researches have examined how training or living at high altitudes plays a vital role on the performance in athletes. Training methods, such as living high-training high (LH-TH) and living high-training low (LH-TL), among others, have been used to illuminate the mechanisms and physiological adaptations that occur in hypoxia (Hoffman, 2002). This review analyses the literature



related to altitude training focused on the physiological effects of training and living in moderate to high altitude, on how physiological adaptations to hypoxic environments influence performance; and on which are the most often protocols used to train in altitude.

Physiological Effect and Acclimatization

The initial failure of the respiratory system to respond to hypoxia is to some extent ameliorated by responses in the blood and the cardiovascular system. Immediately following exposure to high altitudes, red blood cells which are stored mainly in the spleen are released. This increases the level of haematocrit (the ratio of the volume of red blood cells to the total volume of blood), so producing an immediate increase in the capacity of the blood to carry oxygen. Within 12 hours, the rate at which red blood cells are formed also starts to increase, mediated by the glycoprotein hormone, erythropoietin, which stimulates cell division in haematopoietic stem cells in the bone marrow. Erythropoietin is synthesized in hormone-secreting cells in the inner cortex of the kidney in response to hypoxia. The haematocrit level may not peak until after many months of exposure to high altitude (Black & Tenney, 1980). Another physiological response to high altitude is an increase in heart rate and therefore cardiac output. You have seen how it takes time for respiratory control mechanisms to adapt to hypoxia at high altitude. The amount of oxygen delivered to respiring tissues depends on the rate of blood flow to the tissues as well as the value of PO_2 (partial pressure of O_2 , which reflect the amount of O_2 gas dissolved in the blood) in the blood and tissues. Cardiac output is increased by up to five times the resting level at sea-level. In addition, previously constricted capillaries in the tissues open up so enhancing blood supply to the tissues and reducing blood pressure (Hoppeler & Vogt, 2001).

According to Calbet & Lundby (2009), the body responds and adapt to two different stressors, hypoxia and exercise when exercising at altitude. The magnitude of the response to these stressors is influenced by exercise capacity and performance, and this response is mediated by the altitude level and individual characteristics. Adjustments and acclimatization to altitude involve the central nervous, endocrine, respiratory and cardiovascular systems; the blood oxygen-carrying capacity, and morphologic and functional adaptations in the skeletal muscle (Bärtsch & Saltin 2003; Rusko, Tikkanen & Peltonen 2004). The acclimatization process is aimed to obtain an optimal oxygen tension of the arterial blood and to secure an adequate oxygen supply to the body tissues and organs (Bärtsch & Saltin, 2003). Altitude training or training in hypoxia has been used by endurance athletes motivated by the expected enhancement in aerobic and SL performance (Hoppeler, Klossner & Vogt 2003; Gore, Clark & Saunders, 2007). Some of the mechanisms of altitude acclimatization include increase in erythropoiesis, red blood cell (RBC) mass, blood Hb concentration and VO_{2max} at mitochondrial level, elevated muscle efficiency and buffering capacity, as well as improvements in the structural and biochemical properties of skeletal muscle. At tissue level, hypoxia promotes rapid oxygen sensing and consequent cellular functions (Wenger, 2000 Hoppeler, Klossner & Vogt 2003).

Ventilation and Gas Exchange

Respiration both external and internal leads to delivery of oxygen to tissue from atmosphere. In high altitude due to prevailing hypobaric hypoxic conditions, subjects who are exposed to such an environment have to undergo series of adaptations in various steps of oxygen transportation to overcome tissue hypoxia as a result of less availability of oxygen for gas exchange, oxygenation of blood and cellular oxidative phosphorylation. These adaptations are complementary and are acute (immediate to 5 days), sub-acute (over weeks), chronic (months to years) or lifelong depending on the duration of high altitude exposure (Smith, Dempsey & Hornbein 2001).

Ventilation: On rapid ascent to a height of more than 1500 meters, there is a marked increase in ventilation within few hours of exposure due to hypoxia induced respiratory stimulation via carotid body to minimize fall in alveolar partial pressure of oxygen (PO_2) as a result of fall in barometric pressure (Smith, Dempsey & Hornbein 2001). This hypoxic ventilator response (HVR) results in decrease in alveolar PCO_2 (partial pressure of carbon dioxide, it measures CO_2 and serves as a marker of sufficient alveolar ventilation within the lungs) in order to increase PaO_2 for compensating lower partial pressure of oxygen in the blood (PaO_2). Hyperventilation at a given altitude persists over a period of weeks and tends to normalize after few weeks of de-induction to a lower altitude (West 1988). Over a period of days to weeks of stay in high altitude, oxygen saturation of blood improves due to sustained hyper ventilation after abrupt initial drop on acute high altitude exposure. Lung functions in high altitude subjects show reduced gas exchange, fall in vital capacity increase in residual volume, peak expiratory flow and total lung capacity. Lowlanders exposed to high altitude have lower vital capacity due to changes in pulmonary mechanics due to hypoxia and hypocapnia (a decrease in alveolar and blood CO_2 levels below the normal reference range of 35mm Hg).

Perfusion: Lung perfusion is inhomogeneous in both health and disease. Alveolar hypoxia causes hypoxic pulmonary vasoconstriction to facilitate redistribution of blood in various zones of lung to match ventilation and optimize diffusion of oxygen from alveoli to blood (West, 2012).

Diffusion: Decreases with high altitude due to decrease in pressure gradient across alveolar capillary membrane that cannot be compensated even with a resting transit time of 0.75 seconds. Diffusion further decreases with shortened transit time following exercise (West, 1980). As a result, PaO_2 is lowered and is in the range that falls in to the steep portion of the oxygen dissociation curve. This results in marked decrease in oxygen content of the pulmonary capillary blood even with a small decrease in PaO_2 . Long term residents of high altitude have less alveolar arterial oxygen difference, better diffusing capacity and higher mean PaO_2 compared to lowlanders exposed to high altitude.

Haematological Parameters

Plasma volume decreases due to water loss, related to dry environment and hyperventilation and to fluid shift from the intravascular space into the interstitial and intracellular spaces. This loss of plasma volume, and the increase in erythropoiesis and reticulocytes (immature red blood cell) induced by hypoxia cause the augmentation of total haemoglobin and the RBC mass (Friedmann-Bette 2008; Lundby et al. 2007). As a result, the oxygen-carrying capacity of the blood increases, as well as the



oxygen content of arterial blood, being higher than at SL. A significant increase in the RBC mass may occur after 3 weeks at a minimum altitude of 2,100m, becoming more pronounced as altitude increases (Schmidt & Prommer 2008). After 48 hours at altitude the bone marrow increases its iron uptake to form Hb (Drust & Waterhouse 2010). Evaluation of iron levels and supplementation prior and during the stay at altitude is necessary to secure the proper activity of the bone marrow. Inhibition of complete haematological adaptation to training at altitude has been connected to lack of iron and may account for the studies that have failed to show increase in Hb concentration (Rodriguez, Ventura & Casas 2000).

Skeletal Muscle

Hypoxia has been used to induce adaptation in skeletal muscle. It is believed that exposure to hypoxia during exercise increases the metabolic stress and the cellular disturbance. These stimulus are expected to generate adaptive results in muscle tissue beyond those achieved in normoxia (normal level of oxygen) (Vogt & Hoppeler 2010; Baar 2006). Nevertheless, the response is influenced by the hypoxia level, duration and intensity of training. Skeletal muscle adaptations can also occur during extended periods at high altitude. Hypoxia is the predominant force when discussing changes in skeletal muscle. One of the most prominent changes in muscles are the transport of bicarbonate, hydrogen ions, and lactate and are up regulated when exposed to hypoxic situations. The adaptations made will intensify the capacity of all of those ions and help improve the body's ability to maintain the acid-base balance (Bärtsch & Saltin, 2008). Another adaptation is the down regulation of the sodium-potassium pump; however, the significance of this particular change has not been tested. Hypoxia stimulates glycolysis and can increase the availability of pyruvate. The increased availability of pyruvate can either be used for further oxidation in the mitochondria or increased lactate production. As a result of hypoxia, there is a greater lactate response for a given workload. The muscles energy source gains more energy from carbohydrates than fatty acids (Bärtsch & Saltin, 2008). The main cause of these muscular changes can be attributed to the lack of oxygen.

A switch from aerobic to anaerobic glycolysis decreases the consumption of H^+ due to the lowered production of ATP (by oxidative phosphorylation) on the other hand, and a generation of more H^+ by other metabolic reactions, such as the ATPases reaction ($ATP + H_2O \leftrightarrow ADP + P_i + H^+$) on the other hand (Kristian, 2004). During hypoxia, the cellular pH homeostasis is disturbed (Zauner, Daugherty, Bullock & Warner, 2002). A gradual decrease in both extracellular and intracellular pH is observed (Silver & Erecinska, 1992). Studies have shown an approximately drop of 0.8-1.2 pH units (Yao & Haddad, 2004). It is postulated that acidosis might be protective to hypoxic cells. Acidosis can slow down some of the enzymatic processes, reduce energy consumption and ROS (reactive oxygen species, natural byproducts of cellular oxidative metabolism) production (Zauner, Daugherty, Bullock & Warner, 2002).

Energy Metabolism:

Altitude training has been used extensively to enhance performance. However, the evidence is inconclusive in defining the magnitude of the improvement, and in which the influencing mechanisms

could be. Changes in performance after hypoxia training may be associated with changes in aerobic power components; these are: VO_{2max} the fraction of VO_{2max} that represents exercise intensity, and exercise economy (Gore & Hopkins, 2005). Then, changes in endurance performance may be related to changes in these components, in the physiological parameters previously discussed, and in the contribution of anaerobic power (Bonetti & Hopkins 2009). A key adaptive response to chronic hypoxia is a switch from oxidative phosphorylation to anaerobic glycolysis. Under normoxic conditions, cell energy in the form of ATP is mainly generated through the oxidative metabolism of carbohydrates, fats and amino acids. During hypoxia, ATP generation by oxidative phosphorylation is arrested. This will stimulate glycolysis with an increase in glucose consumption and lactate production (Kristian, 2004; Hochachka, Buc, Doll & Land, 1996). The switch of the respiratory pathway to anaerobic glycolysis leads to a significant reduction of the ATP/ADP ratios. Because of the reduced energy supply, the hypoxic cells will further response by shutting down the non-essential energy consuming mechanisms, such as protein synthesis, and relocate the energy to more critical functions, such as the maintenance of the ion homeostasis and membrane potential (Boutilier, 2001; Erecinska & Silver, 2001). A switch in the metabolic pathway to anaerobic glycolysis leads to an increase in the glucose consumption. The largest store of glucose equivalents is glycogen. Indeed, it is observed that during hypoxia, glycogenolysis is induced (Gruetter, 2003).

Altitude Challenge

The initial cardiovascular response to hypoxia is an increase in heart rate and in cardiac output with no changes in stroke volume, and the arterial blood pressure may temporarily increase. After a few days of acclimatization, cardiac output reduces to normal values, with still increased heart rate, so that stroke volume is decreased. In the same time the systemic vascular resistances increase as a response of the adrenal medullary activity and the systemic arterial pressure increase, too. As a consequence of these adaptations, myocardial workload and oxygen demand increase. Because the coronary oxygen extraction is normally physiologically high already at low altitude, the myocardium to adapt to this increased request may almost exclusively act on coronary vasodilatation enhancing coronary blood flow. Ultimately, global systolic indices of ventricular function are preserved or only slightly depressed, with altered diastolic filling pattern. Even if the relationship between workload, cardiac output and oxygen uptake is preserved, a decrease in maximal oxygen consumption and in maximal cardiac output are observed, which is minimal in acute hypoxia but is more important after acclimatization (Naeije, 2010; Scherrer, Allemann, Jayet, 2010). Despite all these consequences, these adaptations are well tolerated and the high altitude exposure doesn't carry risks of myocardial ischemia in healthy subjects (Naeije, 2010). But there are also intracellular changes that operate to reduce injuries of hypoxia and provide sufficient oxygenation when a subject is exposed to altitude. In hypoxic environment, humans are able to switch on activation of numerous genes to increase oxygen delivery.

Another consequence of high altitude is pulmonary hypertension. The increase pressure in pulmonary artery is caused by the hypoxic vasoconstriction of pulmonary small arteries and veins and this response is very variable among humans. The degree of pulmonary hypertension is generally mild and



does not contribute to the symptoms of acute mountain sickness (AMS). It can occur in tourists, as well as in hikers, skiers, and mountaineers. Interestingly, the increase in pulmonary artery pressure occurs both in individuals with AMS and in those who remain asymptomatic after the climb. Excessive pulmonary vasoconstriction plays a role in the development of early high-altitude pulmonary edema (HAPE) and late within week right heart failure at high altitude (Naeije, 2010; Smith, Robbins & Ratcliff, 2008; Donegani, Hillebrandt, and Windsor, 2014). Lowlanders who ascend to medium or high altitudes may develop some degree of AMS, and the common symptoms are headache, sleep disorders, gastrointestinal disorders and dizziness. The degree of susceptibility to this illness varies and in those with vigorous response it may lead to two potential lethal ones, HAPE and high-altitude cerebral edema (HACE). The main cause is hypoxemia and, thus, the treatment is oxygen administration and, in severe cases, in addition to appropriate pharmacological treatment if available, a return to lower altitudes. Acetazolamide administration is the most widely accepted prophylaxis. Staging the ascent attenuates the symptoms of AMS and, thus, is recommended as a way to prevent the most serious clinical conditions as HAPE and HACE (Naeije, 2010).

A person exposed suddenly to an altitude of 3000 m breathes rapidly because peripheral chemoreceptors have stimulated an increase in breathing rate. Explain why this increase in breathing rate is not maintained for longer than a few minutes. As more carbon dioxide is excreted through the lungs owing to the increased breathing rate, PCO_2 in plasma is decreased and eventually PCO_2 in CSF also decreases, resulting in an increased pH, a signal to reduce the breathing rate. The signal from the central chemoreceptors cancels out the signal from the peripheral ones, resulting in a very small net effect on the ventilation rate of the lungs. This example demonstrates the 'conflict' between peripheral and central chemoreceptors. In contrast with other receptors, peripheral chemoreceptors do not adapt but continue firing as long as there is hypoxia. Their continued generation of neural signals increases ventilation a little, so the CSF becomes slightly alkaline. The initial failure of the respiratory system to respond to hypoxia is to some extent ameliorated by responses in the blood and the cardiovascular system. Immediately following exposure to high altitudes, red blood cells which are stored mainly in the spleen are released. This increases the level of haematocrit so producing an immediate increase in the capacity of the blood to carry oxygen. Within 12 hours, the rate at which red blood cells are formed also starts to increase, mediated by the glycoprotein hormone, erythropoietin, which stimulates cell division in haematopoietic stem cells in the bone marrow. Cardiac output is increased by up to five times the resting level at sea-level. In addition, previously constricted capillaries in the tissues open up so enhancing blood supply to the tissues and reducing blood pressure. The lack of oxygen as a result of the ascent from SL to moderate or high altitude impairs the endurance training and performance in the athletes initially (Frisancho, 1993).

CONCLUSION

From the journey so far, the researchers concluded that:

1. The early physiological response and acclimatization to hypoxia is the failure of the respiratory system which is perfected by response in the blood and cardiovascular system followed by the

release of red blood cells that was stored in the spleen thereby increasing the blood carrying oxygen capacity which helps release more energy for a better sport performance.

2. Also, the noticeable increase in ventilation on rapid ascent to a height of more than 1500 meters within few hours of exposure due to hypoxia made respiratory stimulation via carotid body to minimize fall in alveolar PO_2 (PaO_2) as a result of fall in barometric pressure in the athletes.
3. Lowlanders trainers exposed to high altitude have lower vital capacity due to changes in pulmonary mechanics due to hypoxia and hypocapnia have plasma volume decreased due to water loss, related to dry environment and hyperventilation and to fluid shift from the intravascular space into the interstitial and intracellular spaces.
4. Sport Performance has been enhanced extensively by the used of altitude training. Because of Changes in performance after hypoxia training may be associated with changes in aerobic power components.

RECOMMENDATION

Based on the conclusion reached the researchers recommended that:

1. Athletes' should acclimatize to each level of altitude in order to avoid the development of any high altitude sicknesses using a slow ascent.
2. Athletes should drink plenty of water, eat adequately and obtain sufficient sleep to provide enough energy for physical activities.
3. Athletes

References

- Baar K. (2006). *Training for endurance and strength: lessons from cell signaling*. Med Sci Sports Exerc; 38:1939-44.
- Bailey, D.M., Davies, B. (1997). *Physiological implications of altitude training for endurance performance at sea level: a review*. Br J Sports Med; 31(3):183-90.



- Bärtsch, P. Saltin B. Dvorak, J. (2008). *Federation Internationale de Football Association. Consensus statement on playing football at different altitude. Scand J Med Sci Sports* 2008; 18(S1):96-9.
- Bärtsch, P. P., & Saltin, B. B. (2008). *General introduction to altitude adaptation and mountain sickness. Scandinavian Journal of Medicine & Science in Sports*, 181-10.
- Black, C. P. and Tenney, S. M. (1980). *Oxygen transport during progressive hypoxia in high altitude and sea-level waterfowl. Respiratory Physiology*, 39, 217-239.
- Bonetti, D.L. Hopkins, W.G. (2009). *Sea-level exercise performance following adaptation to hypoxia: a metaanalysis. Sports Med*; 39(2):107-27.
- Boutillier, R. G. (2001). *Mechanisms of cell survival in hypoxia and hypothermia J. Exp. Biol*; 204: 3171-3181.
- Brahimi-Horn M. C & Pouyssegu, J. (2007). *Oxygen, a source of life and stress. FEBS Lett*; 681:3582-3591.
- Calbet, J.A. & Lundby C. (2009). *Air to muscle O₂ delivery during exercise at altitude. High Alt Med Biol*; 10(2):123-4.
- Donegani, E. Hillebrandt, D. Windsor, J. (2014). *Pre existing cardiovascular conditions and high altitude travel. Consensus statement of the UIAA Medical Commission. Trav Med Infect Dis*.12(3):237-252.
- Drust, B. Waterhouse, J. (2010). *Exercise at Altitude. Scott Med J*; 55(2):31-4.
- Erecinska, M. and Silver I. A. *Tissue oxygen tension and brain sensitivity to hypoxia. Respir. Physiol*; 128: 263-276
- Friedmann-Bette B. (2008). *Classical altitude training. Scand J Med Sci Sports*; 18(S1):11-20.
- Frisancho, A.R. Frisancho H.G, Milotich M, (1995). *Developmental, genetic, and environmental components of aerobic capacity at high altitude. Am J Phys Anthropol*; 96:431-42
- Frisancho, A.R. (1993). *Human adaptation and accommodation. The University of Michigan Press*: 220-22.
- Gore, C.J. Clark, S.A. Saunders, P.U. (2007). *Non-hematological mechanisms of improved sea-level performance after hypoxic exposure. Med Sci Sports Exerc*; 39(9):1600-9.
- Gruetter, R. G. (2003). *The forgotten cerebral energy store. J. Neurosci. Res*; 74: 179-183.
- Hardie, D. G. (1996) *Minireview the AMP-activated protein kinase cascade: the key sensor of cellular energy status. Endocrinology* 2003; 144: 5179-5183.
- Hochachka, P. W, Buc, L. T, Doll, C. J and Land, S. C. (1996). *Unifying theory of hypoxia tolerance: molecular/ metabolic defense and rescue mechanisms for surviving oxygen lack. Proc. Natl. Acad. Sci. U.S.A*; 93: 9493- 9498.
- Hoffman, J. (2002) *Physiological aspects of sport training and performance. Human kinetics*:247-58.
- Hoppeler, H. Klossner, S. Vogt, M. (2008) *Training in hypoxia and its effects on skeletal muscle tissue. Scand J Med Sci Sports*; 18(S1):38-49.
- Hoppeler, H. and Vogt, M. (2001) *Muscle tissue adaptations to hypoxia. Journal of Experimental Biology*, 204, 3133-3139.

- Hurtado, A. (1971) The influence of high altitude on physiology. In: Porter R, Knight J, eds. *High altitude physiology: cardiac and respiratory aspects*. A Ciba Foundation Symposium in honor of Professor Alberto Hurtado. Williams & Wilkins, Baltimore: p.1-14.
- Kristian, T. (2004). *Metabolic stages, mitochondria and calcium in hypoxia/ ischemic brain damage*. *Cell Calcium*; 36: 221-233.
- Lee, K, Roth, R. A. and LaPres J. J. (2007). *Hypoxia, drug therapy and toxicity* *Pharmacol.Ther*; 113: 229-246.
- Lopez-Barneo, J. Pardal, R. and Ortega-Saenz, P. (2001). *Cellular mechanism of oxygen sensing*. *Annu.Rev.Physiol*; 63: 259-287.
- Lundby, C. Thomsen, J.J. Boushel, R. Koskolou, M. Warberg, J. Calbet, J.A. (2007). *Erythropoietin treatment elevates haemoglobin concentration by increasing red cell volume and depressing plasma volume*. *Journal of Physiology*; 578:309-14.
- Naeije, R. (2010). *Physiological adaptation of the cardiovascular system to high altitude*.*ProgCardiovasc Di*. 2010;52(6):456-466.
- Rodriguez, F.A., Ventura, J.L. Casas, M. (2000). *Erythropoietin acute reaction and haematological adaptations to short, intermittent hypobaric hypoxia*. *Eur J ApplPhysiol*; 82:170-7.
- Rusko, H.K. Tikkanen, H.O. Peltonen, J.E. (2004). *Altitude and endurance training*. *Journal of Sports Science*; 22:928-44.
- Scherrer U, Allemann Y, Jaquet PY, (2010). *High altitude, a natural research laboratory for the study of cardiovascular physiology and pathophysiology*. *ProgCardiovasc Dis*.;52(6):451-456.
- Schmidt, W. Prommer, N. (2008). *Effects of various training modalities on blood volume*. *Scand J Med Sci Sports*; 18(51):59-71.
- Silver, I. A. and Erecinska, M. J.(1992). *Reported on the ion homeostasis in rat brain hippocampus during recovery from short-term transient*.*Cereb.Blood Flow Metab*; 12: 769-772.
- Smith, C.A. Dempsey, J.A, Hornbein, T.F, (2001). Control of breathing at high altitude In Horbein TF, Schoene(RB(eds):*High altitude: An exploration of human adaptation (Lung Biology in Health and Disease, Vol 161)*. New York Marcel Dekker,; 139-174.
- Smith, T.G. Robbins, P.A, Ratcliff, P.J. (2008). *The human side of hypoxia inducible factor*.*Br J Haematol*.;141(3):326-334.
- Toescu, E. C. (2004). *Hypoxia sensing and pathways of cytosolic ca²⁺ increases*. *Cell Calcium*; 36: 187-199.
- Vogt, M. & Hoppeler, H. (2010). *Is hypoxia training good for muscles and exercise performance?* *Prog Cardiovasc Diseases* 2010; 52(6):526-33.
- Wenger, R. H. (2000). *Mammalian oxygen sensing, signaling and gene regulation*. *J. Exp. Biol*; 203:1253-1263.
- West, J.B, & Wagner P.D (1980). *Predicted gas exchange on the summit of Mt. Everest*. *RespPhysiol*; 42:1-16.
- West, J.B. (2012). *High-altitude medicine*. *Am J RespirCrit Care Med*; 186:1229-1237.
- West, J.B. (1988). *Rate of ventilatory acclimatization to extreme altitude*.*RespPhysiol*; 74:323-333.
- West, J.B. (2006). The atmosphere. In: Horbein TF, Schoene RB, eds. *High Altitude: An Exploration of Human Adaptation*. *Lung Biology in Health and Disease*; 161:30-6.



- Wyatt C. N and Evans R. M. (2007) *AMPactivated protein kinase and chemotransduction in the carotid body*. *Respir. Physiol Neurobiol* 2007; 157: 22-29.
- Yao, H. and Haddad, G. G. (2004) *Calcium and PH homeostasis in neurons during hypoxia and ischemia*. *Cell Calcium* 2004; 36: 247-255.
- Zauner A, Daugherty W.P, Bullock, M.R, Warner DS (2002). *Brain oxygenation and energy metabolism: part-biological function and pathophysiology*. *Neurosurgery* 2002; 51(2): 289-301.



EFFECT OF SOCIAL MEDIA PLATFORMS ON TERTIARY INSTITUTIONS STUDENTS ACADEMIC CONCENTRATION IN SOKOTO STATE

¹Gatawa, Ahmad Usman; ²Muhammad Musa Usman; ³Ahmad Hadiza Gusau & ⁴Ibrahim Mudassir
Gatawa

¹Department of Educational Foundations, Sokoto State University, Sokoto Nigeria

²Department of Educational Foundations; Sokoto State University, Sokoto Nigeria

³Department of Science Education; Sokoto State University, Sokoto Nigeria

⁴Department of Educational Foundations; Sokoto State University, Sokoto Nigeria

ABSTRACT

This paper examined the Effect of Social Media Platforms on Tertiary Institutions Students' Academic Concentration in Sokoto State. Social media platforms are computer-mediated tools that allow people to create, share or exchange information, ideas, pictures, and videos in virtual communities and networks. The population of the study is 66,037 comprising of male and female students of Sokoto State tertiary institutions. A sample of 300 was randomly drawn. "Effect of Social Media Platforms on Tertiary Institutions Students' Academic Concentration Assessment Questionnaire" was used to collect the data. The study found that social media platforms have less effect on tertiary institution students' academic concentration. It was recommended that Students in tertiary institutions should be discouraged by parents and lecturers against wasting their precious time accessing social media to avoid its negative effect on their academic concentration. And effective use of internet service for academic purposes should be encouraged and addiction to accessing social media sites be discouraged and in monitoring the academic activities for the betterment of tertiary institutions students, special attention should be paid against social media sites.

Keywords: Internet Usage, Addiction, Academic Concentration, Tertiary Institutions

INTRODUCTION

The social media platforms are rich multi-layered complex ever-changing context for information dissemination and a medium for collaborative interaction between people or group of people regardless of geographical location or limitation. The internet today, is a world-wide entity and its nature cannot be simply defined. To many, the internet is a large computer network linking together millions of smaller computers at numerous sites in various countries belonging to businesses, public organizations, research institutions, educational institutions and so on. However, to the internet users, the internet is a global community one with a very active life. The internet began as "an experiment by the Department of Defence US, in the 1960s to help scientists and researchers from widely dispersed areas work together by sharing scarce and expensive computer and files. This goal requires the creation of a set of connected networks that would act as a co-ordinate whole (Tarantino 2013). Below is a 2019 statistics of world population, unique mobile phone users, internet users, active social media users and mobile social media users.

Addiction to the use of social media platforms lead our youths today to become used to shorthand while writing, common spelling mistakes, and less attention to reading their books among others are threats confronting students' learning due to the kind of concern they have for social media for charts and watching enjoyable films at the expense of reading and research for academic purposes. The Guardian (2014), in a paper released by United States of America (USA), English Spelling Society

concludes that, the internet has become a threat to the English Language, and made error common among internet users particularly the social media users. As people type at speed online, there is now a 'general attitude' that there is no need to correct mistakes or conform to regular spelling rules. This is a terrible attitude that is generating serious challenge to educational development worldwide. The youths, who are the backbone of every development plan are now exploited by misusing social media networks. They write messages using incorrect spelling and receive messages in incorrect spelling due to their addiction to social media. This is dangerous indicator capable of devastating the standard of education (Adeginka, 2010).

The effects of social media include the following: many students rely heavily on the accessibility of information on social media specifically for solutions to their learning and private life problems. This means a reduce focus on learning and retaining information. These lukewarm attitudes of the youths, could eventually direct a student to engage in examination malpractice either within or outside examination hall. A typical example, is the examination villa on the internet where final year students get answers on examinations before going to the examination hall. This is one of the demurrals faced by students particularly in Nigeria. Students who attempt to multi-task checking social media sites while studying showed reduced academic performance. Their ability to concentrate on the task at hand, significantly reduced by the distractions that are brought about by You Tube, Stumble upon, Facebook, Google+, Twitter, etc. materials can only be read and understood when the learner have absolute rest of mind, but what has been read without rest of mind or paying more attention to the material can never be retained. Chat rooms and social websites encourage wrong spellings of English. Internet also, fosters he believe that there is no need to correct typos or conform to rules that English Spelling Society and finds and impose as writing rules. This effect has grown up to the extent that many Colleges and potential employers in the United States of America do investigate an applicants' social networking profiles before granting acceptance or interviews. Most students do not constantly evaluate the content they are publishing online which bring about negative consequences months or year down the road. (Dunn, 2011).

Ghana declared 60% agreement with the scenario of 2020, education will be very different from the way learning was before. There will be mass adoption of teleconference and distance learning to leverage technology resources, a large number of learning activities will move to individualized, just-in-time, there will be a transition to a 'hybrid' classes that combine components of online learning with the lack of lectures on campus. Requirement for graduation will be significantly shifted to the adjusted results. At this time, the increasingly widespread use of the internet, not only in developed countries but also in many developing countries, including Indonesia, India and China. Although the time spent by people in general to perform online access can be very productive. Compulsive internet use can be a bad influence on the life, work and relationships within the family. If your child or a child feels more comfortable friends online than those in the real world, or cannot be trained from playing online games or unlock your smartphone or other gadget, it is possible that you or your children are already using the internet too much (the term: Internet addiction) (Puspita and Rohedi, 2018).



A former student of Manchester University conducted a research on children born into computer age. He declared that we are now witnessing the effect of these linguistic variations on children born into the computer age with such a high level of access in and out of schools. They did not their existence. The paper surveyed a group of 18 to 24 years old as population of the research. It found that majority of the respondents believe that unconventional spellings are used on the internet because it is fast and has become the norm. More than one in every five of the respondents (22%) said that they would not be confident in writing an important email without referring to a dictionary or spell checker. Despite the widespread use of the so-called 'variant' spelling, almost 31% of those questioned said that alternative non-stand spelling was unacceptable," 66% believed that dictionaries should contain variant spellings. This indicated that students use variant spellings and really affect their learning abilities and they are now for means to include these variant spelling in the dictionary (Jones, 2011). Beside the negative effects of social media on educational development, it equally has some positive effects on educational development as stated by Dunn (2011):

- i. Social networking has increased the rate and quality of collaboration for students. They are better able to communicate meeting times or information quickly.
- ii. Social networking teaches students skills they will need to survive in the business world. Being able to create and maintain connections to many people in many industries.
- iii. By spending so much time working with new technologies, students develop more familiarity with computers and other electronic devices.
- iv. The ease with which the students can customize their profiles make more aware of basic aspects of design and layout that are often taught in schools.
- v. The ease and speed with which users can upload pictures, videos, or stories has resulted in a greater amount of sharing of creative works. Being able to get the instant feedback from friends and family on their creative outlets help students refine and develop their artistic abilities and can provide much needed confidence or help them decide what career path they may want to pursue.

Social media platforms are computer mediated tools that allow people to create, share or exchange information, ideas, pictures and videos in virtual communities and networks Wikipedia (2013). Social media is a group of internet-based application that build on the ideological and technological foundations of web 2.0, and that allow the creation and exchange of user generated content. Furthermore, social media depend on mobile and web-based technologies to create highly interactive platforms through which individuals and communities share, core-create, discuss and modify user generated content. They introduce substantial and pervasive changes to communication between businesses, organizations, communities and individuals. These changes are the focus of the emerging field of tech oneself studies. Social media is different from traditional or industrial media in many ways including quality, frequency, usability, immediacy and performance. Social media operates in a dialogic transmission system (many sources to many receivers). It has been broadly defined to refer to the many relatively inexpensive and widely accessible electronic tools that enable anyone to publish and access information, collaborate on a common effort or build relationships (Wikipedia, 2013). Below is a world statistics of time spent on social media platforms instead of research and other academic youth.

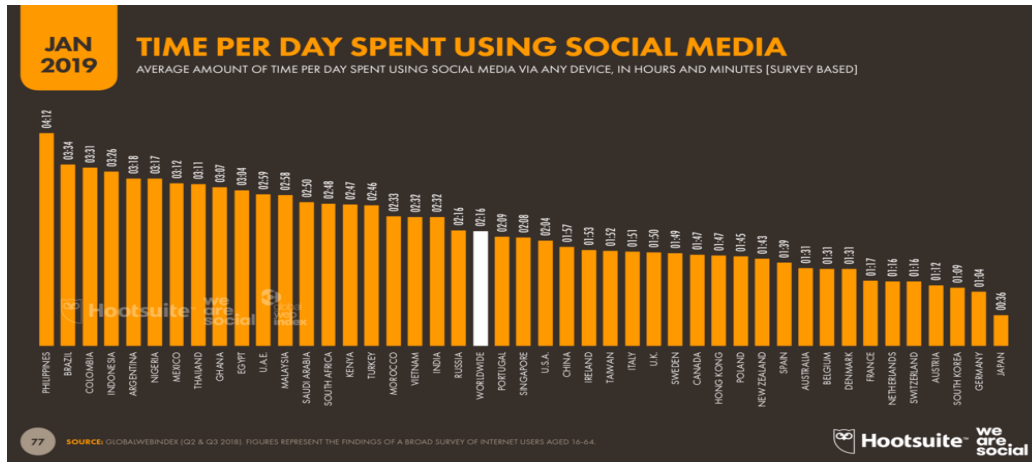

Source: (Kemp 2019)

Other Social Media Platforms include *Instagram*: A photo sharing app that allows users to edit photos and upload them to share with their followers. Users can choose to have a private or a public account. They can share photo directly with a selected few people. This is the equivalent of a private message. *Snapchat*: A message app that allows you to set a timer on the photos and videos the user sends before they disappear. *Tumblr*: A blogging platform but is also similar to twitter in terms of retweeting and sharing others posts. Users can post videos, photos, and writing. *Facebook*: A forum that is used to post pictures, videos, write status updates, articles, and comments. Facebook also contains an option to create pages for different causes and events. *Twitter*: 140 characters microblogging platforms to share ideas, thoughts, and what you had for dinner. (Carini, Kuh & Klein, 2016).



Source: (Kemp 2019)

There is a general consensus amongst teachers that these tools do blur the line between “formal” and “informal” writing but with that being said, in a survey conducted by the National Writing Project (2010), teachers point out that “writing” does not just encompass academic writing done in the classroom. This indicates that more teachers are attuned that writing as a genre is evolving further than essays, reports, and in class writing assignments. However, when teachers and students were asked if they would consider blogging, posting and texting to be writing, both parties did not think so. Writing to teachers and students was confined in the parameters of classroom assignments (Aguilar-Roca, Williams & O’Dowd, 2012). Teachers need to help students see that their blogging, texting, tweeting on social media is real writing. Their writing is real writing because their writing is their voice. Students’ voice needs to be matured and appreciated in the classroom, regardless of the outlet they use to communicate it. When teachers show the important of formal communication to be practiced on social media platforms, students are more inclined to practice good digital citizenship. Students will believe in themselves if we believe in them. We can believe that they produce great thoughts and ideas. We can also believe that social media’s powerful element of connectedness can help to pass on students’ thoughts to drive impactful change in this world (Wang, 2011).

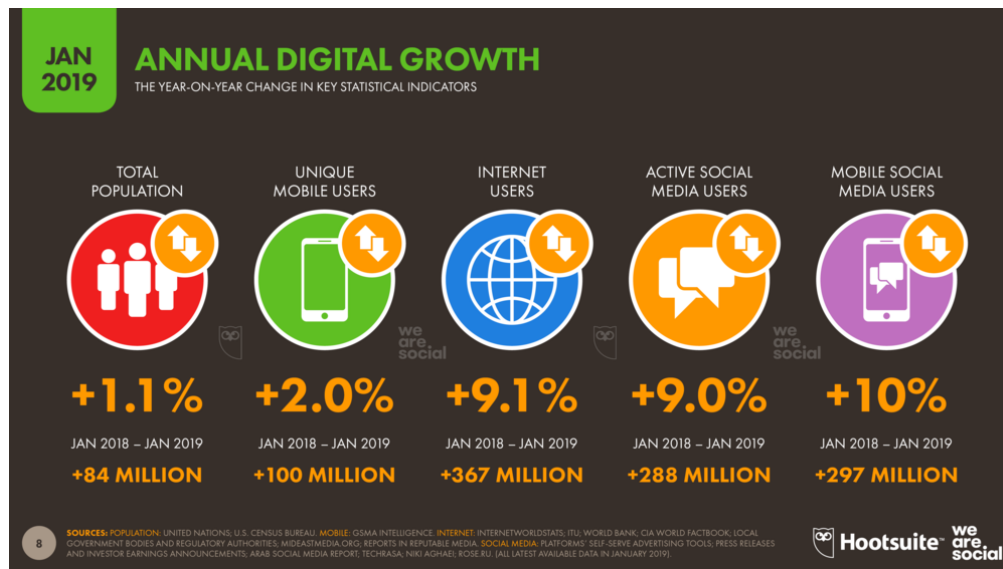

Source: (Kemp 2019)

Adult sites continues to feature strongly in SimilarWeb's rankings too, although Alexa's data tells a slightly different story. All the figures indicated that people spend a lot of time consuming adult video contents. But the amount of time involved may still shock you. Data from SimilarWeb suggest that, in 2019 alone, people spent more than *one billion days* of collective human time on just the top 5 adult sites. The average visit lasts just over 10 minutes. More broadly, video is becoming an increasingly important part of our internet activities. Google searches for the word video increased by 30 percent over the past year, and the query now ranks fourth amongst all global queries, behind Facebook, YouTube, and Google. GlobalWebIndex reports that 92 percent of internet users now watch videos online each month, meaning that more than 4 billion people around the world are consuming online video contents in early 2019. For context, roughly 6 billion people around the world have a television set at home, based on data reported by the ITU. Games have become a huge part of the internet too, from simple mobile games to complex MMORPGs. GlobalWebIndex's data also indicates that more than 1 billion people around the world now stream games over the internet each month, with games like Fortnite becoming global phenomena.

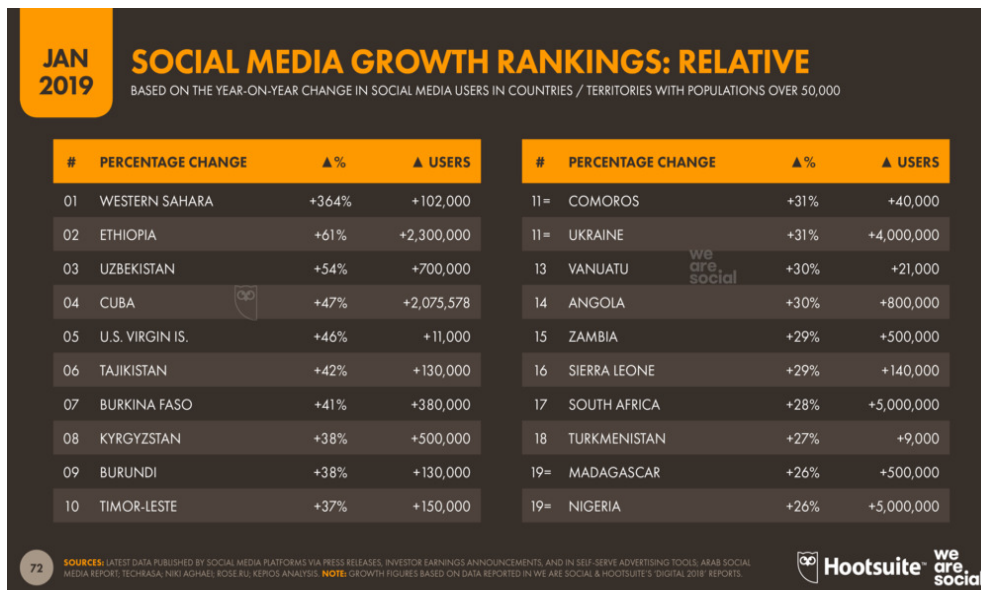

Source: (Kemp 2019)

Global Social Media Behaviours in 2019

The amount of time that people spend on social media has increased again this year, albeit very slightly. GlobalWebIndex reports that the average social media user now spends 2 hours and 16 minutes each day on social platforms – up from 2 hours and 15 minutes last year – which equates to roughly one-third of their total internet time, and one-seventh of their waking lives. As with internet use, this time quickly adds up: if we extend this average daily time across all 3.484 billion people using social media today, we get a combined total of almost 330 million years of human time spent on social platforms during the course of 2019. It's worth noting that the time spent on social media varies considerably across cultures though, with internet users in Japan spending an average of just 36 minutes on social media each day. At the other end of the scale, Filipinos continue to spend the most time on social media, with this year's average of 4 hours and 12 minutes reflecting an increase of 15 minutes per day (6 percent) versus the average that we reported last year. The amount of time that people spend on social media each day has grown considerably over the past 5 years too, with the average user now spending 40 minutes – and 40 percent – longer each day on social compared to this time in 2014.

However, not all of that time is spent 'being sociable. Data from Global

WebIndex shows that 98 percent of internet users in the world's top economies visited a social media platform in the past month, but just 83 percent actively engaged with – or contributed to those platforms. Meanwhile, the average user now has an account on almost nine social media platforms, but they don't necessarily engage with every one of these accounts each month. People are also increasingly using social media for work activities, with almost a quarter of users saying they've done so in the past month. If we extend this average to the total number of social media users around the world, the data suggest that more than 800 million people are using social media for work today.

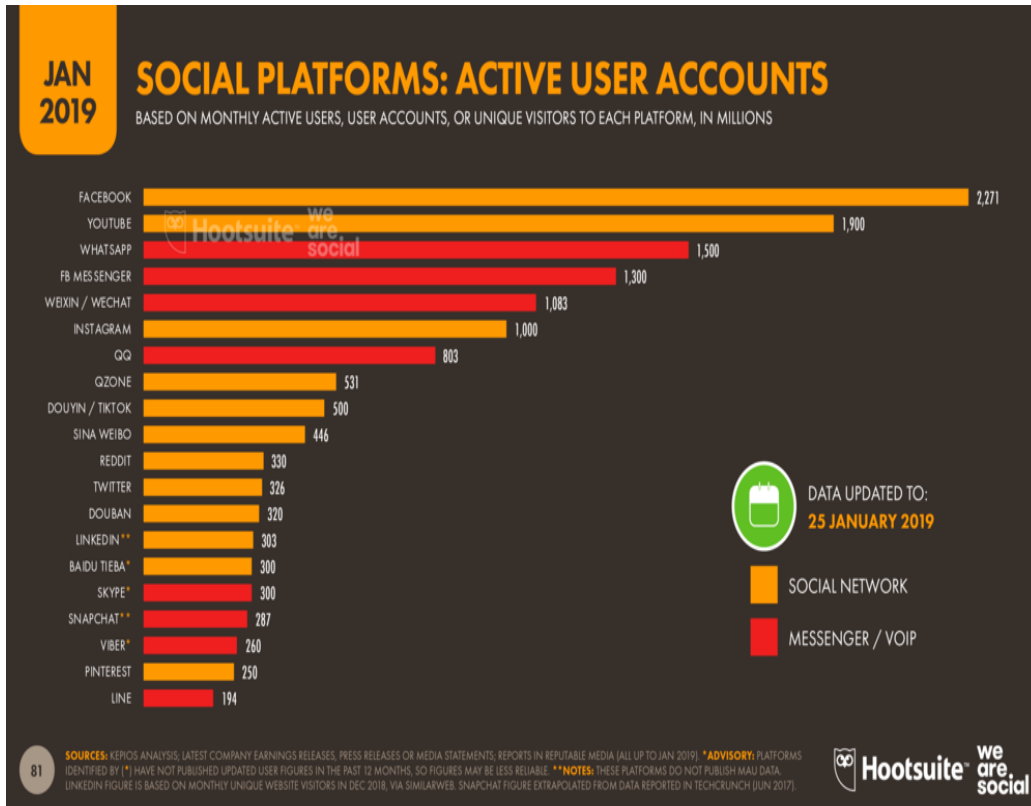



Statement of the Problem

Considering the fast spread and addiction to social media platforms throughout the world and how youths became the most addicted to it as they took it to be a universal hobby for several purposes. Observing the use of shorthand or words abbreviations and spelling mistakes by some students even while writing examinations and how students form social media groups at departmental, Faculty/School, Alumni levels etc... The kind of attention students pay to their phones on the internet, what they are using the internet for has become alarming. Some students in Sokoto State tertiary institutions hide themselves to chat on walking not minding the danger involved, talking chatting, eating chatting, they can't go to bed without visiting social media platforms, to what extent are these students utilizing social media platforms in Sokoto State institutions? It was observed that students now a days give more attention to their phones than their books, are students really concentrating on their studies the way they give time to their social media platforms? This is a common problem occurring on all campuses in Sokoto State progressively. If not address the problem may lead us to a very terrible educational downfall that will affect every aspect and part of the nation educationally, socially, cognitively economically etc. There has been other studies on internet utilization and social media utilization but all their efforts were not able to address the problem. The uniqueness of this study was that it was on the entire social media platforms utilization whereas other studies were on either internet utilization or a particular platform. The goal of this research was to provide lasting solution to the effect of social media platforms utilization on tertiary students' academic concentration in Tertiary Institutions of Sokoto State.

Objectives of the Study

The main aim of the study was to determine the effect of social media platforms utilization in tertiary institutions of Sokoto State. The specific objectives were to:

1. Examine the level of social media platforms utilization among tertiary institution students of Sokoto State.
2. To investigate the purpose of social media platforms utilization among tertiary institution students of Sokoto State.
3. To verify the effect of social media platforms utilization among tertiary institution students of Sokoto State.

Research Questions

The following null hypotheses were raised to guide the study

1. What is the level of social media platforms utilization among tertiary institution students of Sokoto State.
2. For what purposes did tertiary institution students of Sokoto State uses social media platforms.
3. What is the effect of social media platforms utilization among tertiary institution students of Sokoto State.

METHODOLOGY

Survey research design was used to design the research. The population of the study was 66,037 students comprising both male and female. Research Advisor (2006) table for determining sample size was used to take a sample 382 students. The instruments for data collection was adapted from Jones (2013) and titled: Effect of Social Media Platforms Utilization on Tertiary Institutions Students' Academic Concentration Assessment Questionnaire (ESMPUTISACAQ). The questionnaire was validated with the assistance of researcher's colleagues and it was found worthy to collect the expected data for the study. The data was collected by the selected research assistants across all the ten tertiary institutions in the state. The research assistants were trained and directed to target students at social centers, Hostels, Cafeteria and other refreshment points on the campuses. Simple descriptive statistics was used on an SPSS software to analyze the collected data.

Data Presentation and Analysis

Research Question One: What is the level of social media platforms utilization among tertiary institution students of Sokoto State.

Table 4.1. Level of social media platforms utilization among tertiary institution students

S/N	Level of social media platforms utilization among tertiary institution students	SA		A		SD		D	
		F	%	F	%	F	%	F	%
1.	I used the social media platforms less than an hour a day	96	32	96	32	72	24	36	12
2.	I used the social media platforms at least an hour a day	108	36	60	20	60	20	72	24
3.	I used social media platforms more than two hours a day	114	48	66	22	54	18	66	12
4	I used social media platforms more than four hours a day	108	36	36	12	114	48	42	4
6	I have no business with social media platforms at all	24	8	12	4	90	30	174	58
	Average Percentage		32		20		30		18
			62%				48%		

The table above indicated that, tertiary institution students are using social media platforms for various purposes, 64% among the respondents agreed while 36% disagreed that, they used social media platforms less than an hour a day. 56% agreed while 44% disagreed that, they used social media platforms at least an hour a day. 70% agreed and 30% disagreed that they used social media platforms more than two hours a day. 48% agreed and 52 % disagreed that, they used social media platforms more than four hours a day. 12% agreed and 88% disagreed that, they have no business with



social media platforms at all. Conclusively 52% of the respondents agreed and 48% of respondents disagreed with the levels of their social media platforms utilizations.

Research Question Two: For what purposes did tertiary institution students of Sokoto State uses social media platforms.

Table 4.2.: Purposes for using social media platforms by tertiary institution students.

S/N	Purposes for using social media platforms by tertiary institution students	SA		A		SD		D	
		F	%	F	%	F	%	F	%
1.	I used social media platforms for academic purposes only	132	44	64	18	60	20	54	18
2.	I used social media platforms to find friends world wide and get fun	138	46	36	12	60	20	66	22
3.	I used social media platforms for the sake of joining academic forums only	72	24	48	16	102	34	78	26
4	I used social media platforms just for me to know what is going on around the world.	120	40	66	22	36	12	78	26
5	I'm using social media platforms because all my friends are using it and I want to be with them	66	22	24	8	66	22	144	48
Average Percentage			36		16.2		21.6		26
		52.2%				47.6%			

The above table shows that, 44% of the respondents agreed and 56% disagreed that, they used social media platforms for academic purposes. 58% agreed and 42% disagreed that, they used social media platforms for searching friends and catching funs worldwide. 40% agreed and 60% disagreed that, they used social media platforms for the sake of joining academic forums only. 62% agreed and 38% disagreed that, they used social media platforms to know what is going on around the world. Whereas 30% agreed and 70% disagreed that, they used social media platforms because all their friends are using it and they to be with them always. Conclusively 52.2 % of the respondents agreed and 47.6% disagreed with the purposes stated above for using social media platforms.

Research Question Three: What is the effect of social media platforms utilization among tertiary institution students of Sokoto State.

Table 4.3.: Effect of social media platforms utilization

S/N	Effect of social media platforms utilization	SA		A		SD		D	
		F	%	F	%	F	%	F	%
1.	I experienced an encouraging achievement in my academic	18	62	64	18	204	12	24	8

	performance as a result of using social media platforms								
2.	I am contented with the way social media platforms were helping me to concentrate on my studies	144	48	90	30	24	8	42	14
3.	The social media platforms are making good impact on my academic performance	162	64	84	28	36	12	18	6
4	My attention is seriously diverted from my studies due to using social media platforms.	66	22	64	18	72	24	108	36
5	I relied on the social media platforms to resolve most of my academic challenges	96	26	66	22	42	14	96	38
	Average Percentage		42.4		23.2		14		20.4
			65.6%				34.4%		

The table above revealed that, 80% agreed and 20% disagreed that, they are experiencing encouraging achievement in their academic performance as a result of using social media platforms. 78% agreed and 22% disagreed that, they are contented with the way social media platforms are helping them to concentrate on their studies. 82% agreed and 18% disagreed that, the social media platforms are making good impact on their academic performance. 40% agreed and 60% disagreed that, their attentions are seriously diverted from their studies as a result of using social media platforms. 48% agreed and 52% disagreed that they relied on the social media platforms to resolve most of their academic challenges. Conclusively, 65.6% agreed and 34.4% disagreed with the effects of social media platforms utilization mentioned above.

SUMMARY OF THE FINDINGS

The first research question revealed that, all the respondents agreed that they used social media platforms half an hour per day, an hour per day, more than two hours per day and more than four hour a day. The second research question also uncovered that, students are using social media platforms for different purposes ranging from academic purpose, find friends and catching funs, being up to date and joining academic forum. But majority disagreed that, they are using the platforms because their colleagues are using it. The third research question revealed that, majority of the respondents agreed that, utilizing social media platforms has effect on their academic performance.

DISCUSSION OF THE FINDINGS

The first research question found that, all the respondents agreed that, they used social media platforms half an hour per day, an hour per day, more than two hours per day and more than four hour a day this is in line with the work of (Kemp 2019), who work on the rate of growth of social media platforms utilization and annual digital growth worldwide. The second research question found that, students are using social media platforms for different purposes ranging from academic purpose, find friends and catching funs, being up to date and joining academic forum, this is in line with the



work of the third research question agreed with the findings of the Guardian (2014) which found that, social network sites encourage bad spellings and the findings of Dun (2014) which found the 10 Best and worst ways of social media impacts on education. And the findings of (Puspita and Rohedi, 2018) which found that, Ghana declared 60% agreement with the scenario of 2020 that education will be very different from the way learning was before due to the effect of social media utilization.

CONCLUSIONS

Conclusively, the study found that, tertiary institution students of Sokoto state are utilizing social media platforms at different rates, some claimed to use it less than an hour a day, some claimed an hour a day, majority said more than two hours a day, some used it more than four hours a day and few claimed to have no business with social media platforms at all. The study equally found that, students uses social media platforms for different purposes ranging from academic purposes, searching for friends, joining academic forums, getting updates and some use it because all their friends are using it but majority are using it for social activities not academic activities. Majority of the respondents agreed that, social media platforms are making good impact on their academic concentration.

RECOMMENDATIONS

Based on the findings, the following recommendations are made:

- i. Effective use of internet service for academic purposes should be encouraged by tertiary institution administrators, parents and lecturers among tertiary students.
- ii. Students in tertiary institutions should be discouraged by parents and lecturers against wasting their precious times accessing social media to avoid it's negative effect on their academic concentration.
- iii. In monitoring the academic activities for the betterment of tertiary institutions students, special attention should be paid against addiction to social mediaplatforms utilization.

REFERENCES

- TheGuardian (2014). Social Network Sites Encourage Bad Spelling retrieved on 27-5-2016 from www.theguardian.com/technology/internet
- Adeginka, A. A. (2010). Current problems of Educational Development in Nigeria, paper presented at University of Ilorin. Retrieved on 25-5-2016 from www.unilorin.edu.ng/journals/educat...
- Agbonna, S.A., Yusuf, A. & Yusuf, H.T. (2009). Institutional Discrimination and Optimism of Nigerian Fresh Graduates About Choices of Employment. *Nigerian Journal of Social Studies*, Vol. XII(1), PP.197-206.
- Aguiar -Roca, N.M., Williams, A.E., & O'Dowd, D.K. (2012). The impact of laptop-free zones on student performance and attitudes in large lectures. *Computer & Education*, 59, 1300-1308. Retrieved on 11/3/2016 from <http://www.doi:10.1016/j.compedu.2012.06.002>.
- Armstrong, S. (2012) Negative Effect of Social Networking Sites for Students. Retrieved on 12/03/16 from www.businesscommunity.com/socialmedia/negative-effectofsocial-n

- Carini, R.M., Juh, G.D., & Klein, S.P. (2015). Student engagement and student learning: Testing the linkages. *Research in Higher Education*, 47(1), 1-32. Retrieved on 11/3/2016 from <https://www.doi:10.1007/s11162-005-8150-9>.
- Kemp, S. (2019) Global Digital Overview. Retrieved on 21/07/2021 from <https://datareportal.com/reports/digital-2019-global-digital-overview>
- Dunn, J. (2011). The 10 Best and worst ways Social Media Impacts Education. Retrieved on 22/5/2015 from www.edudemiz.com?home>updates.
- Fraenkel, R.J and Wallen, E.N. (1993). *How to Design and Evaluate research*, 4th edn. Illinois: F.E. Peacock publishers Inc.
- Grinnel, M.R.J. (1993). *Social Work Research and evaluation*. 4th edn. Illinois: F.E Peacock publishers Inc.
- Hordle, J. (2014). *Rex Features Press Association*. Retrieved on 20/5/2015 www.edumedic.com>home>updates.
- Jibrin, M.A., Musa, M.N. and Shitu, T. (2017). Effects of internet on the Academic Performance of Tertiary institutions Students in Niger State, Nigeria. *International Journal of Education, learning and training, vol.2 (No.2)* Retrieved on 27/ 07/2018 from www.ftms.edu.my/journals/index.php/journals/ijelt.
- Jones, L. (2013). The effect of linguistic Variations on Children. Report presented at Manchester University, Retrieved on 20/5/2015.
- Krejcie, R.V and Morgan, D.W. (1970). Determining Sample Size for Research activities. *Education and psychological measurement*.
- Puspita, R.V. and Rohedi, D. (2018) the impact of internet Use for Students. *IOP Conference Series: materials Science and engineering*. Retrieved on 27/07/2018 from iopscience.iop.org/article/10.1088/1757-899x/306/1/012106.
- Tarantino, K., McDonough, J., Hua, M. (2013) effect of Students Engagement with Social Media on Student Learning: A Review of literature. *The journal of technology in Students Affairs*. Retrieved on 12-3-2016 from [www.studentsaffaires .com/...effect of stuents engagement with social media](http://www.studentsaffaires.com/...effect of stuents engagement with social media).
- Tukur, A. (2013), *State of Digital Media in Nigeria*. Retrieved 9-12-2013 from [http://twinpinetwork.com/publications/ Nigeria%20state%200f%20digita%20media.pdf](http://twinpinetwork.com/publications/Nigeria%20state%200f%20digita%20media.pdf).
- Wang, D. (2011). *Social Media and Stuent's Communication Skills*. Retrieved on 11-3-2016 from www.edutopia.org/...social-media-students-communicationskills
- Wikipedia, *The Free Encyclopedia* (2013). *Social Media Definition*. Retrieved on 27-5-2015 from en.wikipedia.org/wiki/social-media.
- Wikipedia, *The Free Encyclopedia* (2015). Retrieved on 3-6-2015 from en.wikipedia.org/wiki/edu



ASSESSMENT OF AVAILABILITY AND UTILIZATION OF NATIONAL HEALTH INSURANCE SCHEME HEALTH CARE SERVICES BY WORKERS IN TERTIARY INSTITUTIONS IN NIGER STATE

Audu Ali¹ & Yusuf Abubakar²

¹Department of Physical and Health Education F.C.E Minna, Niger State,

²Department of Human Kinetics and Health Education A.B.U Zaria, Nigeria

E-mail: gakgez337@gmail.com

ABSTRACT

This concern over the years about the health of workers led to the introduction of the National Health Insurance Scheme (NHIS) in Nigeria. This study aimed at assessing the availability and utilization of National Health Insurance Scheme among workers of Tertiary Institutions in Niger State. An Ex-Post Facto design was used for the study. The study population comprised all workers of tertiary institutions in Niger State (male, female, Academics and non-Academics). The sample size used for the study was 400 respondents using the Yamane sample size selection formula. Stratified and proportionate sampling techniques were used to select the respondents based on their total numbers. The instrument used for data collection was 4-point modified Likert rating scale questionnaire. Four hundred (400) copies of questionnaire copies were administered and all were retrieved. The data collected was analyzed using one-way analysis of variance (ANOVA) and Duncan Multiple Range test and two-way independent T-test at 0.05 level of significance. A mean of 2.6 was rated as decision point between the two extremes of agreed and disagreed. The results of the study show that NHIS are not available in most of the tertiary institutions, as such are not been utilized in Niger State at $p < 0.05$. It was therefore recommended that NHIS services should be made available to workers of tertiary institutions in Niger State, so that workers in other establishments within the state will also benefit from the scheme by judiciously utilizing them.

Keywords: Availability, Utilization, NHIS services Workers, Tertiary Institutions

INTRODUCTION

The challenges in providing accessible and affordable healthcare services in developing countries including Nigeria have continually been of concern to international agencies (World Health Organisation, 2007). This is so because health facilities and nutritional requirements are deficient (Owumi, 2002). Living healthy remains a fundamental problem and a number of other problems still prevail including lack of access to affordable healthcare services, poor distribution of healthcare facilities, shortage of drugs, poor attitude of health workers, the enormous cost of health services which is sometimes out of the reach of the poor, poor infrastructure and poor health education strategy (Jegede, 2004). Health insurance scheme as a means of promoting universal health coverage has attracted considerable interest in the past. Yet, the multi-dimensional nature of health insurance makes more studies on health insurance- knowledge or awareness, perception, coverage access and impacts necessary. Therefore, health insurance is defined as a social security arrangement that guarantees the provision of the needed health care services to a person on the contribution of a token to provide financial protection to the participants. Health insurance scheme is a mechanism for protecting families against the unexpected high cost of illness by sharing risks of future cost among healthy and sick populations in the form of regular predictable payments.

Agba (2010), defined health insurance scheme as a contract between an insurance provider with an insurance company or a government, and an individual or his sponsor with an employer or a

community organization. The contract can be renewable monthly, annually or lifelong in the case of private sector insurance, or be even mandatory for all citizen in the case of national health plan. It involves resources mobilization (generation and collection), pooling, allocation and purchasing. A health insurance scheme should provide quality, equitable, accessible, affordable and efficient health care. It should ensure a significant reduction in out-of-pocket expenditure and it should provide universal coverage. It should also provide a comprehensive good quality and cost effective of health services to entitled and insured persons and their dependents in the formal sector, self-employed, rural communities, poor and vulnerable groups the benefit prescribed. Therefore, social health insurance is a social security system that guarantees the provision of a benefit package of health care services paid from fund created by pooling the contribution of participants.

In terms of benefits, health insurance scheme was discovered to have two side of its coin; Empirical studies suggested that workers in jobs with health insurance coverage had higher productivity and lower turnover than workers without health insurance benefits (O'Brien, 2003; Collins, Davis, Doty, Kriss & Holmgren, 2006). On the other hand, other studies suggested that offering health insurance has very little or no effect on job turnover (Collins, White & Kriss, 2007). However, it is generally believed that people without health insurance are more likely to be in worse health condition and have higher death rates than those people with health insurance coverage because they are less likely to seek medical care. The need for effective healthcare services became paramount after the Second World War, when there was rapid development of healthcare systems in Europe and America. The World Health Organization (WHO) stimulated changes in national health policies and greater emphasis was placed on basic health services especially in the developed nations of the world. Dispensaries and health centres were built and a network of rural health facilities were established to cater for the growing need for health services in the world, Nigeria inclusive (Campbell, 2007). The provision of health services for the people at the grass root level was seen as a step that can be used to tackle health problems in communities across the globe, which led to the launching of Primary Health Care as a key to the attainment of health provision to all by the year 2000 and beyond (Yusuf, 2002; Federal Ministry of Health, 2008; & Ajagi, 2004).

The National Health Insurance Scheme (NHIS) in Nigeria which has been in existence over the years has served employees in the formal sector. In this scheme, the health care of the employee is paid for with funds created by pooling together the contributions of employees and employers. The employees pay 10% while the employers pay 5% representing 15% of the employee's basic salary (NHIS, 2010). This contribution covers health care benefit package for the employee, a spouse and four (4) biological children below the ages of 18 years. The scheme as at February, 2009 had registered over 4 million federal civil servants and their dependants (Agba, 2010). Health Insurance Serves as a means of promoting Universal Health Coverage which has attracted considerable interest in the past (WHO, 2007). Yet, the Multi-dimensional nature of health insurance generally makes more studies on different areas such as its coverage and access a necessity.



Availability and utilization of healthcare services in every community in Nigeria is very essential. This is because without knowledge and adequate healthcare services and proper utilization of same, the health of the people will be in jeopardy and will no doubt affect gross productivity and national income. Availability and utilization of healthcare services promote and protect the health of the individual, as well as prevent the spread of diseases and other ailments that may affect the people. Availability of good healthcare services and utilization are the basis for all human development. When there is awareness of healthcare services, and they are adequately available and utilized by the people, it will help in improving their health status, thereby reducing ill-health among the people, and improve efficiency and productivity. It is not yet ascertained whether health service under NHIS are available and been utilized. Also various studies were done on the effectiveness of NHIS service among civil servants in the state neglecting its availability and level of utilization by workers in tertiary institutions in Niger State. As such, the researchers become motivated to conduct this study purposely to assess availability and utilization of health care services by staff of tertiary institutions in Niger state, Nigeria.

Research Questions

1. Are the healthcare services provided by National Health Insurance Scheme available for workers of tertiary institutions Niger State?
2. Do workers of tertiary institutions in Niger State utilize the available healthcare services under the National Health Insurance Scheme?

Hypotheses

1. The availability of the services provided by National Health Insurance Scheme for workers of tertiary institutions is not significantly different.
2. The utilization of the available health care services provided by National Health Insurance Scheme for workers of tertiary institutions is not significantly different.

METHODOLOGY

Ex-Post-Facto research design was used in this study. The population in focus consisted of all academic and non-academic staff of tertiary institutions in Niger State amounting to eight thousand eight hundred and three (8,803) (Niger State Owned Tertiary Institutions and Management Board, 2015). A total 404 respondents were proportionately selected for the study. The entire population was divided into homogeneous groups called strata, and then the items were selected from each stratum using simple random sampling without replacement. Niger State was stratified into three senatorial zones namely, North West, North East and North South. The research instrument used in this study was a four point modified Likert rating scale developed by the researcher. To ensure face and content validity of the instrument, a draft copy of the researcher-structured questionnaire was submitted to five (5) professional experts in Faculty of Medicine and Department of Physical and Health Education, Ahmadu Bello University, Zaria, Nigeria for vetting. The comments and suggestions of the experts were taken into consideration and reflected in the final copies that were distributed to the respondents. The researcher employed the services of three research assistants (one from each of

the sampled senatorial zones) at their various working places. The respondents were required to complete the questionnaire and return them later the same day. Four hundred 400 (100%) copies were retrieved upon which the data analysis was conducted. The statistical techniques used in analyzing the data collected for this study was inferential statistics of ANOVA and Duncan multiple range test to test the variation of respondents' availability and utilization of National Health Insurance Scheme in their various tertiary institutions at 0.05 level of significance.

Answering Research Question

Research Question 1

Are the healthcare services provided by National Health Insurance Scheme available for workers of tertiary institutions in Niger State?

Table 2: Descriptive Statistics of the Availability of National Health Insurance Scheme Healthcare Services

S/No.	Items	Mean	Standard Deviation
1.	All the prescribed essential drugs are available in the NHIS pharmacies	1.54	0.97
2.	Restorative and rehabilitative services for physiotherapy are available in NHIS partner hospitals/ clinics	1.26	0.66
3.	There are radiology/ medical imaging and diagnostics laboratory services in NHIS partner hospitals/ clinics	2.16	1.14
4.	There are maternal and child care services in NHIS partner hospitals/ clinics	1.26	0.69
5.	There are accident and emergency services in NHIS partner hospitals// clinics	1.27	0.71
6.	There are curative services for common ailment including consumables for out of patient care in NHIS partner hospitals/ clinics	1.29	0.77
7.	There are hospitalization facility in general wards for a maximum of fifteen days in a year in NHIS partner hospitals and clinics.	2.06	1.18
8.	There are diagnostic laboratory services in NHIS partner hospitals and clinic.	1.34	0.80
9.	There preventive and controlled health problems as health counseling and testing services in NHIS partner hospitals and clinic.	1.34	0.80
10.	There are surgical services in NHIS partner hospitals in clinics.	1.61	2.77
	Aggregate mean	1.61	0.63



Table 2 above shows that item number 3 had the highest mean score (2.15), which indicates that the respondents agreed that there are radiology/ medical imaging and diagnostics laboratory services in NHIS partner hospitals/ clinics . Item 3 is closely followed by item number 7, with a mean score of 2.06, which indicates that there are hospitalization facility in general wards for a maximum of fifteen days in a year in NHIS partner hospitals and clinics. Responses to other items were not in the infirmity, that is, respondents did not agree to all other opinions contained in the table except items number 3 and 7 as interpreted above. The relative mean scores of these items were less than the criteria of 2.0 which imply that the respondents disagreed with the suggested items. These include item number 1,2,4,5 6, 8, 9 and 10. The aggregate mean score of 1.61 indicates that National Health Insurance Scheme Services are not available in tertiary institutions in Niger State.

Research Question 2

Do the workers of tertiary institutions in Niger state utilize the available healthcare services under the National Health insurance Scheme?

Table 3. Descriptive Statistics of the Utilization of National Health Insurance Scheme Healthcare Services

S/No.	Items	Mean	Standard Deviation
1.	I patronize NHIS pharmacies for all my prescribed drugs	1.20	0.67
2.	My family healthcare needs are taken care better by NHIS partner hospitals/ clinics	1.26	0.71
3.	I always go for primary eye care, dental and mental care in NHIS partner hospitals/ clinics	1.39	0.80
4.	My families always go for routine laboratory investigations in NHIS partner hospitals/ clinics	1.26	0.70
6.	My family always go for preventive and controlled health problems such as health counseling and testing services in NHIS partner hospitals/ clinics	1.49	0.89
6.	I do take my children to NHIS partner hospitals/ clinics for all medicare	1.42	0.88
7.	My family always go for maternal and child care services in NHIS partner hospitals and clinics.	2.75	1.09
8.	My family go for specialized healthcare for medical and gynecology internal medicine services in NHIS partner hospitals and clinics.	2.54	0.98
9.	My family go for out-patient department of accident and emergency wards in NHIS partner hospitals and clinics.	2.54	0.99
10.	My family go for consultant and health personnel in NHIS partner hospitals and clinics.	1.38	0.84
	Aggregate mean	1.72	0.14

Table 3 above shows that item number 7 had the highest mean score (2.75), which indicates that the respondents family always go for maternal and child care services in NHIS partner hospitals and clinics. Next to the item 7 is item number 8, with a mean score of 2.54, indicating that the respondent's family go for specialized healthcare for medical and gynaecology, internal medicine services in NHIS partner hospitals and clinics. Next to the item 8 is item number 9, with a mean score

of 2.59, indicating that the respondent's family go for out-patient department of accident and emergency wards in NHIS partner hospitals and clinics. More so, the table shows that respondents disagree with all other items listed in the table, this include items number 1, 2, 3, 4, 5, 6 and 10 (1.20, 1.26, 1.39, 1.26, 1.49 and 1.38) respectively. The aggregate mean score of 1.72 indicates that the workers in tertiary institutions in Niger State do not utilize the services of National Health Insurance Scheme.

Hypothesis Testing

H₀, The availability of health care services provided by NHIS for workers of tertiary institutions in Niger State is not significantly different.

Table 4: One-Way Analysis Of Variance for Variation in the Availability of NHIS Services among Workers Of Tertiary Institutions in Niger State

	Sum of Squares	Df	Mean Square	F	F-critical	P-value
Between Groups	217.734	11	19.794	.704	1.75	.735
Within Groups	10904.704	388	28.105			
Total	11122.438	399				

F (399); 1.75 = p>.0.05

Table 4 indicates that the availability of National Health Insurance Scheme Services differ significantly among workers of tertiary institution in Niger State. The F-test in the table which equal .704 is a ratio of between- group estimate and within- group estimate. Since the p-value in the ANOVA table is greater than 0.05 (P>0.05), there is no statistically significant difference between the mean of respondents on availability of health care services by NHIS. In this case, the null hypothesis is therefore accepted at the 95% confidence level. Though significant difference did not exist among the variables, the researcher feel that the insignificant difference may present an inside insignificant differences among them. This thought made the researcher to run Duncan multiple range test to further reveal the insignificant differences among the variables.

Post Hoc Tests

Table 5: Multiple Range Tests on the Variation in the Availability of NHIS Services among Tertiary Institutions Workers in Niger State.

Duncan^{ab}

Name of Tertiary Institution you are working	N	Subset for alpha = 0.05
		1
IBB University, Lapai	83	34.4699
School of Nursing, Bida	3	34.6667
School of Midwifery, Minna	4	34.7500
Niger State Polytechnic, Zungeru	38	35.3168



Federal Poly, Bida	71	36.6362
Federal College of Education, Kontagora	31	36.6462
F.U.T. Minna	109	36.8632
College Agric. Mokwa	11	36.3636
College of Education, Minna	36	36.6714
JAFIA, Minna	8	37.3760
School of Health Tech. Minna	4	37.6000
School of Health Tech. T/Magajija	3	38.0000
Sig.		.284

Table 6 above is a Duncan multiple range test table to compare the variability in availability of NHIS services among workers of tertiary institution in Niger State. From the table, the means differ significantly from each other.

Table 6 One-Way Analysis of Variance for Variation in the Utilization of NHIS Services among Workers of Tertiary Institutions in Niger State.

	Sum of Squares	Df	Mean Square	F	F-critical	P-value
Between Groups	346.789	11	31.436	1.766	1.76	.058
Within Groups	6906.288	388	17.800			
Total	7252.077	399				

$F(399); 1.76 = p > 0.05$.

Table 6 above is to test the significant difference in the utilization of National Health Insurance Scheme services by workers of tertiary institution in Niger State. Since the p-value in the ANOVA table is more than 0.05, therefore the null hypothesis is accepted and concluded that, there is no statistical significant difference in the utilization of National Health Insurance Scheme health care services among workers of tertiary institutions in Niger State at 95% or higher confidence level ($P < 0.05$). Though significant difference does not exist among the variables, the researcher feel that the insignificant difference may present an inside insignificant differences among them. This thought made the researcher to run Duncan multiple range test to further reveal the insignificant difference among the variables.

Table 7: Multiple Range Tests on the utilization of NHIS services among workers of tertiary institutions in Niger State
 Duncan^{ab}

Name of Tertiary Institution you are working	N	Subset for alpha = 0.05	
		1	2
School of Health Tech. T/Magajija	3	32.0000a	
IBB University, Lapai	83	34.6266ab	34.6266ab
School of Midwifery, Minna	4	34.7600ab	34.7600ab
F.U.T. Minna	109	36.7064ab	36.7064ab
Federal Poly, Bida	71	36.7746ab	36.7746ab

College Agric. Mokwa	11	36.9091ab	36.9091ab
Niger State Polytechnic, Zungeru	38	36.0263ab	36.0263ab
JAFIA, Minna	8	36.2500ab	36.2500ab
School of Health Tech. Minna	4	36.2500ab	36.2500ab
School of Nursing, Bida	3	36.6667ab	36.6667ab
Federal College of Education, Kontagora	31	36.6774ab	36.6774ab
College of Education, Minna	36		37.8857bc
Sig.		.066	.209

Table 7 above is a Duncan multiple range test table to compare the variability in the respondent's utilization of NHIS services. From the table, means with same superscript do not differ significantly from each other. As such the hypothesis is retained.

DISCUSSION

The finding for this study revealed that, the summated mean for availability and utilization is 1.61 and 1.72 respectively. This result is worrisome due to the fact that it is expected of tertiary institutions employees to be aware and utilize all the available services of the government but that was not the case with NHIS. This situation is pathetic as one wonders what the situation will be in other formal sectors where the employees are less learned and enlightened, worst still in informal sectors. Therefore significant variation in the availability and utilization of the scheme can be attributed to major factor of location of the institutions. For some institutions are located in the urban areas while others in the semi urban areas. This finding is in agreement with Umar (1999) and Andrew (2007). According to Umar (1999), reasons for the differences are related to difference in type of Health Care facility, the availability of professional personnel, functional equipment, and hours of service delivery. In line with the postulates of the central place theory, health care delivery facilities in Nigeria which are of three grades (primary, secondary and tertiary) can be conceived as constituting a hierarchical system with the tertiary facilities at the top, the secondary facilities in the middle and the primary facilities below. This hierarchical system is reflected in space by the geographical arrangements of service outlet in which a particular area tend to have numerous primary health facilities, much fewer secondary facilities and very few tertiary facilities if at all.

CONCLUSION

The researchers therefore concluded that there are radiology/ medical imaging and diagnostics laboratory services in NHIS partner hospitals/ clinics and that there is hospitalization facility in general wards for a maximum of fifteen days in a year in NHIS partner hospitals and clinics in Niger State which indicates the availability of the NHIS services. Also, families of workers in tertiary institutions in Niger State always go for maternal and child care services in NHIS partner hospitals and clinics. They also go for specialized healthcare for medical and gynecology internal medicine



services in NHIS partner hospitals and clinics which indicated a reasonable level of utilization of health care services.

RECOMMENDATION

The researchers recommend that NHIS services should be made available to workers of tertiary institutions in Niger State, so that workers in other establishments within the state will also benefit from the scheme by judiciously utilizing them.

REFERENCES.

- Agba, M. S. (2010). *The Impact of Monetization of Fringe Benefits on the Productivity of Nigeria workers: The case of Federal Polytechnic, Idah Kogi States* Unpublished M.Sc. Thesis Submitted to the Department of Public Administration and Local Government, University of Nigeria, Nsuka, 1 – 100
- Ajayi, F. T. (2004). *A guide to PHC practice in developing countries 4th edition*, Akure Rotimi Excels Production.
- Andrew, L. C. (2007). "User charges for health care: a review experience" *Health Policy and Planning* 6(4) 309-319.
- Campbell, C. (2007). *Essentials of health management planning and policy*. Yaba, Lagos. University of Lagos Press.
- Collins, S.R, White, C. Kriss, J. (2007). *Whither employer based health insurance? The current and Future Role of United States Companies in the Provision and Framing of Health Insurance*. The Commonwealth Fund Publication Number 1059.2007. Available at www.commonwealthfund.org.
- Collins, S.R., Davis, K. Doty, M.M., Kriss, J.C. & Holingren, A.C. (2006). *Gaps in wealth insurance: An all-American Problem*. The Commonwealth fund Publication Number 920. www.commonwealthfund.org.
- FMOH (2008): *Training manual for management of malaria in Nigeria*. National malaria and vector control programme. Nigeria.
- Jegede. A. (2004). *Problems and prospects of health care delivery in Nigeria: Issues in Political Economy and Social in Equality In Currents and Perspective in Sociology*. Isiugo-Abanihe U.C. Isamah A.N. and Adesina J.O. (eds) Ibadan Malt house press limited, 212-226.
- Krejcie R. V. & Morgan (1970). *Determining Sample Size for Research Activities*. Educational and Psychological Measurement. Retrieved from <http://opauprrp.edu/invisdocs/krejcieandmorgan> on 30- 06 2007.
- National Health Insurance Scheme (2010). *NHIS – News–State Partners with NHIS Online* Available at: <http://www.nhis.gov.ng/index.Php?> Retrieved October 3, 2010.
- Niger State Owned Tertiary Institutions and Boards (2015). *Fact sheet*
- O' Brien, E. (2003), *Employers Benefits from workers Health Insurance*. The Mil. Quart: AJ. Pub. Health Care Poly 81 (1), <http://www.malbonk.org/quarterly/8101 feat.html>

- Owumi, B.E. (2002). *The political economy of maternal and child health in Africa* in Isiugo-Abanine U.C; Isamah A.N., Adesina, J. O. (eds) *Currents and perspectives in sociology*. Malthouse Press Limited, P.227-239.
- Umar, U. (1999). Shortage of Registered Nurses and its effect on Health care Delivery in Sierra-leonc: a case study of freetown *West African Journal of Nursing*. 20(1).19-26.
- World Health Organization (2007). *Roundtable discussion on in efficiency and wastage in the health sector*. WHO. Genera Plateau State Website. www.plateaustategov.org.
- Yusuf, U. (2002). *Primary health care. Introduction to public health for beginners in community health*. Ibadan University Press.



FEEDING TRIAL AND ECONOMIC OF BROILER FINISHER FED VITAL FEED AND SOME AGRO-BY PRODUCTS

Danwe A.B, Christopher G, Adamu F, Liman A.A, Aishatu F, Elizabeth F. and Aji A.
Department of Animal Production,
College of Agriculture Jalingo, Taraba State Nigeria.
Email: danweaugustine@gmail.com

ABSTRACT

The research was experimented to study the economic and performance of broiler finisher on vital feed and graded levels of some agro-by products. The experimental birds used were sixty (60) in number aged five weeks, were assigned to four treatments in a completely randomized design replicated thrice with fifteen (15) birds per treatment. Diet T_1 , was a control diet of 100% VF while diets T_2 , T_3 and T_4 were mixed with some agro-by products of 40% SC, 40% CHP and 40% CH respectively. The findings shows that the total final, average and total daily body weight were significant at ($p > 0.01$). While average daily body weights, total daily feed intake average daily feed intake, and feed conversion ratio were significant at ($p > 0.05$). Then the cost savings (₦/kg) in which the Economic analysis was purposely experimented was best on T_4 , T_3 and T_2 with (₦330/kg), (₦290/kg) and (₦250/kg) respectively, and poorest on control diet with (₦0.00/kg). The carcass characteristics were significant ($p > 0.05$) on carcass weight, heads weight, sharisk weight and gizzards weight while other are not significant ($p > 0.05\%$). Agro-by products such as cowpea husk and sorghum chaff could be incorporated into poultry feeds to reduce cost of poultry feeds.

Keywords: Effective broiler production, bridging animal protein, maximize profit, self-employment, agro-by products

INTRODUCTION

The problem of malnutrition particularly animal protein malnutrition is clear in Nigeria (Ekumankama 2000). The level of animal protein in the diet of an average Nigerian has not reached the level recommended for good health and development (Aitsu 2002). This is partly due to poverty, high cost of animal products (meat, milk and eggs) coupled with current economic insecurity and instability (Ani et.al, 2006) which have affected the price of the available conventional ingredients; this tends to increase the cost of production as a result of competition for these scarce conventional feed ingredients between man and animals (Ekengem and Onyeagoro 2006) stated that an alternative source of feed ingredients worth exploiting as a better feed supplement with little cost (Madubuike et al, 2001) include some of these agricultural by-products such as cowpea husk (*vignaanguiculata*) and sorghum chaff. Thereby reducing present challenges to farmers and nutritionists in Nigeria (Etuk, etal, 2000) regarding feeding of poultry to maximize profit in broilers production which is a type of chicken raised specifically for meat production typically known as Cornish crosses or Cornish rocks specially bred for large scale efficient meat production and grow faster than egg or traditional dual purpose breeds (Beyer,2002)

MATERIALS AND METHODS

The study Area

The experiment was conducted at the poultry unit of Taraba State College of Agriculture Jalingo. The site of the experiment is located at latitude $8^{\circ}53''$ North and longitude $11^{\circ}33'$ East. It has an annual

[]

rainfall range from 1,000 to 1,500mm and mostly falls between May to October with an ambient temperature of 30–38°C (Taraba State Diary 2010)

Pre-Experimental Design

Cornish crosses broiler chicks of three weeks figured sixty (60) were purchased from a certified poultry farm and were fed the experimental diet twice daily in the morning and in the evening, the birds were observed to ensure that feed were available and water offered *ad-lib-tum*. Sanitation was adhered strictly throughout the experimental period. The birds were given experimental diets for two weeks to accustom to the experimental diets before the commencement of the experiment proper. The experiment was continued after the adjustment period.

Proper-Experimental Design

Cornish crosses broiler chicks of three weeks numbered sixty (60) were purchased from a certified poultry farm and were fed the experimental diet twice daily in the morning and evening, the birds were randomly allocated to four (4) treatments of fifteen (15) birds per treatments, each treatment was replicated thrice (3x) with five (5) birds per replicate. The birds from each replicate and treatments were weighted once a week and the experiment lasted for four weeks.

Experimental Diets

Three experimental diets were used for the finisher period with vital feed as basal diet, while cowpea husk and sorghum chaff were used as the test ingredients of the experiments. The basal feed (control) was used as T_1 , 100%, T_2 60%, T_3 60% and T_4 60%. Cowpea husk without potash as T_1 0%, T_2 0%, T_3 0% and T_4 40%. Cowpea husk with potash as T_1 0%, T_2 0%, T_3 40% and T_4 0%. Then sorghum chaff as T_1 0%, T_2 40%, T_3 0% and T_4 0% of the broiler finisher portion of the experimental diets of T_1 , T_2 , T_3 and T_4 respectively.

PROCESSING OF EXPERIMENTAL DIETS

Cowpea husk and sorghum chaff were used as the test diets. The cowpea husk with and without potash were per boiled for 30 minutes sundry and mill separately. Then sorghum chaff was also per boiled for 30 minutes, sundry and mill. While treatment one (T_1) as basal or control diet was the vital feed with T_1 100%, T_2 60%, T_3 60% and T_4 60% respectively.

Animal Management

The birds were assigned to each pen, the initial weight of individual bird was taken and the average weight of each treatment was also taken to ensure that the differences among the treatments were negligible (insignificant). Adjustment period of two (2) weeks was allowed to enable the birds to pass out the previous feed eaten and get accustomed to the feed and the environment. After the adjustment period, the experiment proper started. The birds were fed twice a day (morning and evening) and water was offered freely.



Data Collection

The feeds supplied and refusal was weighted every morning and evening to compute daily feed intake before the commencement of the next feeding.

Weight gain and measurement (g)

The initial weight of each bird and the total initial weight of each treatment were taken while the initial average weight of treatment were also taken and later at weekly intervals for the final live weight of the birds and weight gain. The experiment lasted for four weeks.

Economic Analysis

The cost per kg feed and cost of feed per unit weight gain were also computed. Subsequently, cost savings (₦/kg) were analyzed to indicate which among the treatments had the highest and lowest cost savings (₦/kg)

Carcass Characteristics

At the end of nine weeks of the experiment, three (3) birds from each treatment were randomly selected and starved overnight to clear the guts. The live weights of the birds were recorded before bleeding by cutting the jugular veins. Eviscerations of the birds were also done. The initial organs, heads and feet were weighted separately. The lengths of the large intestine, small intestines and caecum of the birds were measured to know the differences in length

Chemical Analysis

The proximate analysis of the diets were determined by association of official analysis chemists (A.O.A.C, 1990) to evaluate the feed sample components such as Dry Matter, Crude Protein, Crude Fibre, Ether Extract, Ash and Nitrogen Free Extract Metabolizable Energy (ME) was estimated according to pazenga (1985) method

Statistics Analysis

The performance and carcass characteristics data obtained were subjected to analysis of variance (ANOVA) (Steel and Torrie, 1980), significant means were compare using least significant difference (LSD) to determine which means were different from others.

RESULT AND DISCUSSION

The experiment was conducted with vital feed (basal diet) and some agro-by products in Taraba State College of Agriculture Jalingo, the subsequent results obtained were discussed alongside with the tables indicated below:

Table 1: proximate composition and energy values

Nutrients %	T ₁ 100% VF	T ₂ 40% SC	T ₃ 40% CHP	T ₄ 40% CH
Dry matter	96.60	96.70	96.90	96.80
Crude protein	19.20	18.20	18.00	17.80
Crude fibre	5.40	20.40	19.20	19.00
Ether extract	8.48	7.60	6.50	7.20
Ash	2.30	6.60	10.30	7.20
Nitrogen free extract	50.23	51.5	52.99	54.12
ME (Kcal/kg)	3146	3146	3200	3060

ME = Metabolizable energy, estimated according to Puzenga (1985) method as follows:

$$ME = (\text{Kcal/kg}) = 36 \times CP\% + 81.8 \times EE\% + 36.6 \times NFE\%$$

VF = Vital feed

SC = Sorghum chaff

CHP = Cowpea Husk with potash

CH = Cowpea Husk without potash



Table 2: Performance of Broiler Finisher Fed some graded levels of Cowpea Husk and Sorghum Chaff

Parameters	T ₁ 100% VF	T ₂ 40% SC	T ₃ 40% CHP	T ₄ 40% CH	LSD
Total initial wt (g)	22530	22540	22538	22536	NS
Average initial wt (g)	7510	7513	7512	7511	NS
Total final wt (g)	44504 ^a	30306 ^d	35625 ^c	3826 ^b	11.12**
Average final wt (g)	14835 ^a	10102 ^d	11875 ^c	12753 ^b	5.13**
Total daily body wt (g)	628 ^a	222 ^d	374 ^c	449 ^b	6.20**
Average daily body wt (g)	209 ^a	74 ^d	125 ^c	147 ^b	7.10*
Total daily feed intake (g)	3686	2143	2700	2914	15.14*
Average daily feed intake (g)	1229 ^a	714 ^d	900 ^c	971 ^b	3.10*
Feed conversion ratio	2.36 ^a	3.40 ^d	3.20 ^c	3.04 ^b	5.04*

a,b,c,d = with different superscript on the same rows are significantly different

** = P>0.01 (means significant at 0.01%)

* = P>0.05 (means significant at 0.05%)

NS = P<0.05 (Means not significant at 0.05%)

LSD = Least significant different

VF = Vital feed

SC = Sorghum Chaff

CH = Cowpea husk boiled without potash

CHP = Cowpea Husk boiled with potash

Average Daily Weight Gain

All the birds in the four dietary treatments increased in weight, but at different levels as indicated by the superscripts. Diets with superscripts a, b, c and d respectively were more digestible (useful) by the birds in that order.

Average Final Weight Gain

Diet 1 been the control diet was fully accepted by the birds and the chronological preferability of the test diets were diets 4, 3 and 2 respectively. As the birds weight were increased based on the preference of the diets.

Average Daily Feed Intake

The average daily feed intake was best in the control diet 1, as diet 4 progressive to match with diet 1 bud at distance level, likewise diet 3 and the least was diet 2.

Table 3: Economic Analysis of Broiler Finisher Feed Some Graded Levels of Cowpea Husk and Sorghum Chaff

Parameters	T ₁ 100% VF	T ₂ 40% SC	T ₃ 40% CHP	T ₄ 40% CH
Total feed intake (g)	3686	2143	2700	2914
Total feed intake (kg)	3.69	2.14	2.70	2.91
Feed cost (Nkg)	300	50	70	70
Total feed cost (Nkg)	998.91	1001.40	1000.00	1001.37
Total weight gain (Nkg)	44.50	30.30	35.62	38.26
Feed cost (Nkg) gain	22.45	33.05	28.07	26.17
Cost savings (Nkg)	-	250	290	330

Economic Analysis

The analysis disclosed that the cost per kg feed and cost of feed per unit weight gain were reduced on T₂ 40% SC but with less weight gain than T₃ 40% CH and T₄ 40% CHP that had an increased weight gain (N50.00k/kg and N70.00k/kg. treatment 4 was the best test diet in preference which was the cowpea husk parboiled with 5g of potash

Table 4: Carcass Analysis of broiler finisher feed same graded level of Cowpea Husk and Sorghum Chaff

Parameters	T ₁ 100% VF	T ₂ 40% SC	T ₃ 40% CHP	T ₄ 40% CH	LSD
No of birds slaughtered	3	3	3	3	
Final weight (g)	8900	7800	8000	8200	NS
Weight of bled birds (g)	8800	7700	7800	7900	NS
Weight of feathered birds (g)	8850	7640	7700	7800	NS
Carcass weight (g)	8200	6950	7050	7150	14.60*
Dressing percentage (%)	96.88	65.65	76.40	80.60	17.62*
Heads weight (g)	85.00	57.24	61.00	72.01	13.65*
Shanks weight (g)	370.20	270.00	230	250	14.43*
Liver weight (g)	120	95.00	102	105	NS
Gizzard weight (g)	50	60	70	72	15.75*
Length of small intestine (cm)	120	110	115	116	NS
Length of large intestine (cm)	98	70	80	85	NS
Length of caecum (cm)	60	48.30	55	56.0	NS

A,b,c,d means with different superscript on the same rows are significant different

* P<0.05 (means significant at 0.05%)

NS= P>0.05 (means not significant at 0.05%)

VF=Vital feed

SC= Sorghum chaff

CH=Cowpea Husk without potash

CHP = Cowpea Husk with potash

Carcass Analysis

The carcass characteristics revelation differs at significant level of P>0.05% in carcasses heads, shanks, gizzards and dressing% weights to that of intestines, caecum, liver, final weight, among other P>0.05% level

CONCLUSION

In conclusion of the experimental test diets (cowpea husk and sorghum chaff), could be incorporated up to 40% level without adverse effects on the performance and economic analysis of broiler finishers which could equally reduce the cost of feeds as the test diets were cheaper, less competitive compared to conventional feed stuffs.

REFERENCES



- Ani, A.O; Adjegwu L.I. and Adeginka, J.A. (2005). The feeding value of velvet beans (*Macuna prunens*) to weaner Rabbit Proc-30th Annual confress of Nig. Sco. For Anim prod (N.S.A.P) March 20th-24th 2005. University of Nigeria Nsuka Nigeria 186-189
- Atsu, D.W (2002). Contributory role of animal production in Nigeria pp 39-46
- Beyer, R.S (2002). Frequent questions asked about poultry extension specialists, poultry science department of animal science, Kansas state university.
- Ekumanrikama, O.O (2000). Promoting micro-livestock in the new millennium. The proceedings of 25th NSAP Conference, Umudike, Nig. Pp 330-336
- Etuk, P.O (2002). Replacement value of pigeon pea (*cajanus cajan*) seed meal and maize in broiler finisher diet proc. 7th annual conference Animal Sci. Ass. Of Nigeria (ASAN) Abeokuta, Nigeria Pp. 157 – 160
- Madubuike, F.N. and Ekengem B.U. (2001). Non ruminant livestock production in the tropics guest chucks graphics, Owerri Nigeria pp. 185-202
- Steel, R.G.S. and Torrie J.A. (1980). Principles and procedures of statistics: A. Biometric approach 2nd edition Mc Grain-Hill, Kogakusha Ltd Tokyo



FEEDING TRIAL AND ECONOMIC OF BROILER FINISHER FED VITAL FEED AND SOME AGRO-BY PRODUCTS

Danwe A.B, Christopher G, Adamu F, Liman A.A, Aishatu F, Elizabeth F. and Aji A.
Department of Animal Production,
College of Agriculture Jalingo, Taraba State Nigeria.
Email: danweaugustine@gmail.com

ABSTRACT

The research was experimented to study the economic and performance of broiler finisher on vital feed and graded levels of some agro-by products. The experimental birds used were sixty (60) in number aged five weeks, were assigned to four treatments in a completely randomized design replicated thrice with fifteen (15) birds per treatment. Diet T_1 , was a control diet of 100% VF while diets T_2 , T_3 and T_4 were mixed with some agro-by products of 40% SC, 40% CHP and 40% CH respectively. The findings shows that the total final, average and total daily body weight were significant at ($p > 0.01$). While average daily body weights, total daily feed intake average daily feed intake, and feed conversion ratio were significant at ($p > 0.05$). Then the cost savings (₦/kg) in which the Economic analysis was purposely experimented was best on T_4 , T_3 and T_2 with (₦330/kg), (₦290/kg) and (₦250/kg) respectively, and poorest on control diet with (₦0.00/kg). The carcass characteristics were significant ($p > 0.05$) on carcass weight, heads weight, sharisk weight and gizzards weight while other are not significant ($p > 0.05\%$). Agro-by products such as cowpea husk and sorghum chaff could be incorporated into poultry feeds to reduce cost of poultry feeds.

Keywords: Effective broiler production, bridging animal protein, maximize profit, self-employment, agro-by products

INTRODUCTION

The problem of malnutrition particularly animal protein malnutrition is clear in Nigeria (Ekumankama 2000). The level of animal protein in the diet of an average Nigerian has not reached the level recommended for good health and development (Aitsu 2002). This is partly due to poverty, high cost of animal products (meat, milk and eggs) coupled with current economic insecurity and instability (Ani et.al, 2006) which have affected the price of the available conventional ingredients; this tends to increase the cost of production as a result of competition for these scarce conventional feed ingredients between man and animals (Ekengem and Onyeagoro 2006) stated that an alternative source of feed ingredients worth exploiting as a better feed supplement with little cost (Madubuike et al, 2001) include some of these agricultural by-products such as cowpea husk (*vignaanguiculata*) and sorghum chaff. Thereby reducing present challenges to farmers and nutritionists in Nigeria (Etuk, etal, 2000) regarding feeding of poultry to maximize profit in broilers production which is a type of chicken raised specifically for meat production typically known as Cornish crosses or Cornish rocks specially bred for large scale efficient meat production and grow faster than egg or traditional dual purpose breeds (Beyer, 2002)

MATERIALS AND METHODS

The study Area

The experiment was conducted at the poultry unit of Taraba State College of Agriculture Jalingo. The site of the experiment is located at latitude $8^{\circ}53''$ North and longitude $11^{\circ}33'$ East. It has an annual

[]

rainfall range from 1,000 to 1,500mm and mostly falls between May to October with an ambient temperature of 30–38°C (Taraba State Diary 2010)

Pre-Experimental Design

Cornish crosses broiler chicks of three weeks figured sixty (60) were purchased from a certified poultry farm and were fed the experimental diet twice daily in the morning and in the evening, the birds were observed to ensure that feed were available and water offered *ad-lib-tum*. Sanitation was adhered strictly throughout the experimental period. The birds were given experimental diets for two weeks to accustom to the experimental diets before the commencement of the experiment proper. The experiment was continued after the adjustment period.

Proper-Experimental Design

Cornish crosses broiler chicks of three weeks numbered sixty (60) were purchased from a certified poultry farm and were fed the experimental diet twice daily in the morning and evening, the birds were randomly allocated to four (4) treatments of fifteen (15) birds per treatments, each treatment was replicated thrice (3x) with five (5) birds per replicate. The birds from each replicate and treatments were weighted once a week and the experiment lasted for four weeks.

Experimental Diets

Three experimental diets were sued for the finisher period with vital feed as basal diet, while cowpea husk and sorghum chaff were sued as the test ingredients of the experiments. The basal feed (control) was used as T_1 , 100%, T_2 60%, T_3 60% and T_4 60%. Cowpea husk without potash as T_1 0%, T_2 0%, T_3 0% and T_4 40%. Cowpea husk with potash as T_1 0%, T_2 0%, T_3 40% and T_4 0%. Then sorghum chaff as T_1 0%, T_2 40%, T_3 0% and T_4 0% of the broiler finisher portion of the experimental diets of T_1 , T_2 , T_3 and T_4 respectively.

PROCESSING OF EXPERIMENTAL DIETS

Cowpea husk and sorghum chaff were used as the test diets. The cowpea husk with and without potash were per boiled for 30 minutes sundry and mill separately. Then sorghum chaff was also per boiled for 30 minutes, sundry and mill. While treatment one (T_1) as basal or control diet was the vital feed with T_1 100%, T_2 60%, T_3 60% and T_4 60% respectively.

Animal Management

The birds were assigned to each pen, the initial weight of individual bird was taken and the average weight of each treatment was also taken to ensure that the differences among the treatments were negligible (insignificant). Adjustment period of two (2) weeks was allowed to enable the birds to pass out the previous feed eaten and get accustomed to the feed and the environment. After the adjustment period, the experiment proper started. The birds were fed twice a day (morning and evening) and water was offered freely.



Data Collection

The feeds supplied and refusal was weighted every morning and evening to compute daily feed intake before the commencement of the next feeding.

Weight gain and measurement (g)

The initial weight of each bird and the total initial weight of each treatment were taken while the initial average weight of treatment were also taken and later at weekly intervals for the final live weight of the birds and weight gain. The experiment lasted for four weeks.

Economic Analysis

The cost per kg feed and cost of feed per unit weight gain were also computed. Subsequently, cost savings (₦/kg) were analyzed to indicate which among the treatments had the highest and lowest cost savings (₦/kg)

Carcass Characteristics

At the end of nine weeks of the experiment, three (3) birds from each treatment were randomly selected and starved overnight to clear the guts. The live weights of the birds were recorded before bleeding by cutting the jugular veins. Eviscerations of the birds were also done. The initial organs, heads and feet were weighted separately. The lengths of the large intestine, small intestines and caecum of the birds were measured to know the differences in length

Chemical Analysis

The proximate analysis of the diets were determined by association of official analysis chemists (A.O.A.C, 1990) to evaluate the feed sample components such as Dry Matter, Crude Protein, Crude Fibre, Ether Extract, Ash and Nitrogen Free Extract Metabolizable Energy (ME) was estimated according to pazengra (1985) method

Statistics Analysis

The performance and carcass characteristics data obtained were subjected to analysis of variance (ANOVA) (Steel and Torrie, 1980), significant means were compare using least significant difference (LSD) to determine which means were different from others.

RESULT AND DISCUSSION

The experiment was conducted with vital feed (basal diet) and some agro-by products in Taraba State College of Agriculture Jalingo, the subsequent results obtained were discussed alongside with the tables indicated below:

Table 1: proximate composition and energy values

Nutrients %	T ₁ 100% VF	T ₂ 40% SC	T ₃ 40% CHP	T ₄ 40% CH
Dry matter	96.60	96.70	96.90	96.80
Crude protein	19.20	18.20	18.00	17.80
Crude fibre	5.40	20.40	19.20	19.00
Ether extract	8.48	7.60	6.50	7.20
Ash	2.30	6.60	10.30	7.20
Nitrogen free extract	50.23	51.5	52.99	54.12
ME (Kcal/kg)	3146	3146	3200	3060

ME = Metabolizable energy, estimated according to puzenga (1985) method as follows:

$$ME = (\text{Kcal/kg}) = 36 \times CP\% + 81.8 \times EE\% + 36.6 \times NFE\%$$

VF = Vital feed

SC = Sorghum chaff

CHP = Cowpea Husk with potash

CH = Cowpea Husk without potash



Table 2: Performance of Broiler Finisher Fed some graded levels of Cowpea Husk and Sorghum Chaff

Parameters	T ₁ 100% VF	T ₂ 40% SC	T ₃ 40% CHP	T ₄ 40% CH	LSD
Total initial wt (g)	22530	22540	22538	22536	NS
Average initial wt (g)	7510	7513	7512	7511	NS
Total final wt (g)	44504 ^a	30306 ^d	35625 ^c	3826 ^b	11.12**
Average final wt (g)	14835 ^a	10102 ^d	11875 ^c	12753 ^b	5.13**
Total daily body wt (g)	628 ^a	222 ^d	374 ^c	449 ^b	6.20**
Average daily body wt (g)	209 ^a	74 ^d	125 ^c	147 ^b	7.10*
Total daily feed intake (g)	3686	2143	2700	2914	15.14*
Average daily feed intake (g)	1229 ^a	714 ^d	900 ^c	971 ^b	3.10*
Feed conversion ratio	2.36 ^a	3.40 ^d	3.20 ^c	3.04 ^b	5.04*

a,b,c,d = with different superscript on the same rows are significantly different

** = P>0.01 (means significant at 0.01%)

* = P>0.05 (means significant at 0.05%)

NS = P<0.05 (Means not significant at 0.05%)

LSD = Least significant different

VF = Vital feed

SC = Sorghum Chaff

CH = Cowpea husk boiled without potash

CHP = Cowpea Husk boiled with potash

Average Daily Weight Gain

All the birds in the four dietary treatments increased in weight, but at different levels as indicated by the superscripts. Diets with superscripts a, b, c and d respectively were more digestible (useful) by the birds in that order.

Average Final Weight Gain

Diet 1 been the control diet was fully accepted by the birds and the chronological preferability of the test diets were diets 4, 3 and 2 respectively. As the birds weight were increased based on the preference of the diets.

Average Daily Feed Intake

The average daily feed intake was best in the control diet 1, as diet 4 progressive to match with diet 1 bud at distance level, likewise diet 3 and the least was diet 2.

Table 3: Economic Analysis of Broiler Finisher Feed Some Graded Levels of Cowpea Husk and Sorghum Chaff

Parameters	T ₁ 100% VF	T ₂ 40% SC	T ₃ 40% CHP	T ₄ 40% CH
Total feed intake (g)	3686	2143	2700	2914
Total feed intake (kg)	3.69	2.14	2.70	2.91
Feed cost (Nkg)	300	50	70	70
Total feed cost (Nkg)	998.91	1001.40	1000.00	1001.37
Total weight gain (Nkg)	44.50	30.30	35.62	38.26
Feed cost (Nkg) gain	22.45	33.05	28.07	26.17
Cost savings (Nkg)	-	250	290	330

Economic Analysis

The analysis disclosed that the cost per kg feed and cost of feed per unit weight gain were reduced on T₂ 40% SC but with less weight gain than T₃ 40% CH and T₄ 40% CHP that had an increased weight gain (N50.00k/kg and N70.00k/kg. treatment 4 was the best test diet in preference which was the cowpea husk parboiled with 5g of potash

Table 4: Carcass Analysis of broiler finisher feed same graded level of Cowpea Husk and Sorghum Chaff

Parameters	T ₁ 100% VF	T ₂ 40% SC	T ₃ 40% CHP	T ₄ 40% CH	LSD
No of birds slaughtered	3	3	3	3	
Final weight (g)	8900	7800	8000	8200	NS
Weight of bled birds (g)	8800	7700	7800	7900	NS
Weight of feathered birds (g)	8850	7640	7700	7800	NS
Carcass weight (g)	8,200	6950	7050	7150	14.60*
Dressing percentage (%)	96.88	65.65	76.40	80.60	17.62*
Heads weight (g)	85.00	57.24	61.00	72.01	13.65*
Shanks weight (g)	370.20	270.00	230	250	14.43*
Liver weight (g)	120	95.00	102	105	NS
Gizzard weight (g)	50	60	70	72	15.75*
Length of small intestine (cm)	120	110	115	116	NS
Length of large intestine (cm)	98	70	80	85	NS
Length of caecum (cm)	60	48.30	55	56.0	NS

A,b,c,d means with different superscript on the same rows are significant different

* P<0.05 (means significant at 0.05%)

NS= P>0.05 (means not significant at 0.05%)

VF=Vital feed

SC= Sorghum chaff

CH=Cowpea Husk without potash

CHP = Cowpea Husk with potash

Carcass Analysis

The carcass characteristics revelation differs at significant level of P>0.05% in carcasses heads, shanks, gizzards and dressing% weights to that of intestines, caecum, liver, final weight, among other P>0.05% level

CONCLUSION

In conclusion of the experimental test diets (cowpea husk and sorghum chaff), could be incorporated up to 40% level without adverse effects on the performance and economic analysis of broiler finishers which could equally reduce the cost of feeds as the test diets were cheaper, less competitive compared to conventional feed stuffs.

REFERENCES



- Ani, A.O; Adjegwu L.I. and Adeginka, J.A. (2006). The feeding value of velvet beans (*Macuna prunens*) to weaner Rabbit Proc-30th Annual confress of Nig. Sco. For Anim prod (N.S.A.P) March 20th-24th 2006. University of Nigeria Nsuka Nigeria 186-189
- Atsu, D.W (2002). Contributory role of animal production in Nigeria pp 39-46
- Beyer, R.S (2002). Frequent questions asked about poultry extension specialists, poultry science department of animal science, Kansas state university.
- Ekumanrikama, O.O (2000). Promoting micro-livestock in the new millennium. The proceedings of 25th NSAP Conference, Umudike, Nig. Pp 330-336
- Etuk, P.O (2002). Replacement value of pigeon pea (*cajanus cajan*) seed meal and maize in broiler finisher diet proc. 7th annual conference Animal Sci. Ass. Of Nigeria (ASAN) Abeokuta, Nigeria Pp. 157 – 160
- Madubuike, F.N. and Ekengem B.U. (2001). Non ruminant livestock production in the tropics guest chucks graphics, Owerri Nigeria pp. 186-202
- Steel, R.G.S. and Torrie J.A. (1980). Principles and procedures of statistics: A. Biometric approach 2nd edition Mc Grain-Hill, Kogakusha Ltd Tokyo



EFFECT OF SOWING DATES ON SOME GROWTH AND YIELD PARAMETERS OF BENNISEED (*Sesamum indicum*) AS PRODUCED IN BAUCHI, BAUCHI STATE, NIGERIA

Nangi J. I. Dutse, A. Garba, & A.S.Fagam

¹Department of Crop Production Technology, Bauchi State College of Agriculture, Bauchi, Bauchi State, Nigeria.

^{2,3}Crop Production Programme, AbubakarTafawa Balewa University, Bauchi

ABSTRACT

A field experiment was carried out during the rainy seasons of 2005, 2006 and 2007 at the Abubakar Tafawa Balewa University Teaching and Research Farm, Bauchi, to study sowing date on the growth and yield of sesame (*Sesamum indicum* L.). The treatments consisted of three sowing dates which were, 30/6¹, 15/7 and 30/7. These treatments were laid out into a Randomized Complete Block Design (RCBD). From results obtained and analysed it indicated Sowing sesame on 15th and 30th July produced heavier seeds than when the crops are sown on 30th June, there was no clear distinction among the different sowing dates on number of capsules per plant. Effect of Sowing date sesame yield and yield related characters revealed sowing date having significant effect on sesame number of capsules per plant throughout the period of the investigation Significantly heaviest 1000(g) seed weight was observed in crops sown on July 15 & 30 (2.03, 2.03), while significantly highest seed yield(kg/ga) was observed in crops sown on 30-6, in 2006. Cropping season, hence sesame producers in the study area advised to sesame their sesame early as soon as the rain establishes.

INTRODUCTION

Sesame (*Sesamum indicum* L.) also referred to as benniseed belongs to the family Pedaliaceae and genus *Sesamum*. In Nigeria the crop is often referred to as benniseed. The name of the crop in some Nigerian local dialects are Ridi in Hausa, Ishawa in Tiv, Yamatior Eeko in Yoruba, Igorigo in Igbira and Doo in Lukun. It consists of 36 species of which the most commonly recognised is *Sesamum indicum*. Sesame is one of the oldest cultivated oil crops known and used by man, even though its domestication has been lost in antiquity. The crop is said to have originated in Africa, probably in West and Central parts of the continent. Sesame is very popular in parts of central north- western and north eastern zones of the country where it is grown.

Sesame production in Nigeria probably began in the middle belt region of the country and later spread out to other parts. It is cultivated between latitude 6° and 10°. It is basically considered a crop of the tropics; it is commonly grown by small holder farmers and the major producing states in Nigeria include Nasarawa, Jigawaa and Benue states. The other important sesame producing areas are Yobe, Kano, Katsina, Kogi, Gombe and Plateau states (Chemonics, 2002). Sesame is a short day plant but certain cultivars have become adapted to different photoperiods, with 10-hour days it will normally flower in 42-45 days after sowing. Temperature and moisture have major modifying effects on the number of days to flowering. Temperatures around 30°C encourages germination, initial growth and flower formation, up to 40 °c will be tolerated by specific varieties. Temperatures below 20 °c normally delay germination and seedling growth and temperatures below 10 °c inhibits germination:

Sesame produces an excellent crop with a rainfall of 500-650 mm p.a. This amount should be evenly distributed during the crop growing season. Ideally, 35% of rain should fall during germination until first bud formation, 45% until main flowering and 20% at seed filling. Rain should cease as first capsules begin ripen. Heavy rain at flowering drastically reduces yield. Sesame is very susceptible to water logging. After elongation sesame is susceptible to wind damage It does well on well drained soils with PH of 6.5 to 8.0. Most varieties are sensitive to soil salinity.(Protabase, 2011). Planting of sesame must be done as early in the rains as establishes. (Nature land 2002) In a research conducted by Oluwe (2007) in the forest savannah transition zone of south western Nigeria revealed that sesame sown in early July were taller than those sown in late August and late July which were shorter all through the period of his work. This was attributed to adequate moisture in the soil during establishment and vegetative periods of early July sown sesame crop. Delay in sowing sesame into late August significantly reduced number of branches per plant

**Effect of Sowing Dates on some Growth and Yield Parameters of Benniseed
(*Sesamum indicum*) as Produced in Bauchi, Bauchi State, Nigeria**

Sesame seeds from which half of their weight is oil are most commonly used in soup vegetables. Various parts of the plant are used for native medicine, the stems are usually burned as fuel where fire wood is scarce and the wood ash is commonly used for local soap production. The processed cake remaining after oil is removed is a rich source of protein for farm animals. Sesame therefore might have developed from being a crop of negligible importance to being one the major cash crops in the areas of production in Nigeria (Salako and Falusi, 2004)

Sesame one of the major oil crops in Nigeria production has generally been on a small scale when compared to that of groundnut. This may not be unconnected with the low level of awareness among Nigerian farmers on the agronomy of the crop and possibly, areas that are suitable for its production. Time of sowing the crop could be a critical factor for optimum production especially in Bauchi state where most of the farmers sow their sesame late because of the little importance attached to the crop when compared with food crops being cultivated in the same area such as millet, guinea corn, maize, rice or cowpea. Sesame producer in the state generally cultivate different varieties without giving much attention to their yield potentials.

Sesame producers in Bauchi state, especially the southern zone, where this research was conducted sow their crops as late as the month of August, of which may not be profitable in terms of yield potential especially with the erratic nature of rain being experienced in the region of recent. Hence the core objective of this research was to "Investigate the Effect of Sowing Dates on some Growth and Yield Components of sesame varieties in Bauchi, Bauchi State, Nigeria".

MATERIALS AND METHODS

A field experiment was conducted during the wet seasons of 2005, 2006 and 2007 at the Teaching and Research Farm of Abubakar Tafawa Balewa University Bauchi, Nigeria. Bauchi is located on Longitude, 10° 17', Latitude, 9° 49' E and 609.3m above sea level in the northern guinea savannah ecological zone of Nigeria. The treatments were three sowing dates which were; 30th June, 15th July and 30th July. These treatments were laid out in a randomized complete block design and replicated three times. The treatments were allocated to individual plots giving a total of nine plots of 2.25m² x 2.25m² sizes each. Between plots, a distance of 0.5m was left for each across and work way for observation and data collection. Before sowing the crop, soil samples were collected at a depth of 0-30cm, and 30-60 using a tabular auger. The samples collected were then taken for analysis to determine the physico-chemical properties of the research area. The soil sampling and analysis were carried out three times at the beginning of every planting season before sowing the crop. The samples taken were analysed for, soil properties, textural class, organic carbon, total N and exchangeable cations. The method used for the analysis was that of Black (1965).

As for sowing clean and treated seeds of three varieties which were used.

Each was weighed out to a volume of 1.4g per 2.25m² and mixed with dry sand at a ratio of 1:3 seed to sand. The mixture was then applied carefully observing the planting periods as stated above. A uniform inter row spacing of 30cm was adopted however no specific intra row spacing was used since spacing here may be controlled. The first weeding was carried out at 2 weeks after emergence (WAE) as when the crops became fully established and are distinguishable from weeds. Subsequently weeds were removed as at when due until the crops had fully developed leaf canopies to be able to cover and suppress further weed development. Black ants (*Messor Barbara L.*) were observed to be picking seeds not properly covered at sowing time. As a remedy to this, each plot was treated with an insecticide: Permethrin (0.60%) locally referred to as pit puff

The crop was harvested at physiological maturity. Maturity here was observed as the stem, leaves and pods turned yellow. The crops were harvested as soon as half of the plant population was matured. The remaining plants however were subsequently harvested as they became matured later. Sharp sickle was used to cut mature plants at about some few centimetres above the ground level. The mature harvested plants were carefully bundled and put on a clean dry



sack where it was left to dry under the sun immediately after harvest. After sun drying, the pods were then carefully threshed in a clean semi airtight sack to avoid seed scattering. Threshed seeds were winnowed to obtain clean seeds?

Parameters that were taken in the course of the research were: Percentage seed emergence, Plant height (cm), Leaf area (cm²), Number of branches per plant, Number of capsules per plant, Evenness of crop maturity per plot, 1000 seed weight and final seed yield per treatment.

RESULTS AND DISCUSSIONS

Table 1: Physico- chemical properties of soil collected at 0-30 cm depth of the experimental site in Bauchi, during 2005, 2006 and 2007 rainy seasons.

Soil properties.	Year		
	2005	2006	2007
Sand %	61.9	68.24	71.6
Silt %	13.42	15.12	11.6
Clay %	24.68	16.64	16.72
Textural class	Sandy loam	Sandy loam	Sandy loam.
PH:w(1=1)	5.86	5.86	6.41
PH:c(1=1)	5.14	5.29	5.71
Organic carbon(g/kg)	12.65	10.51	5.71
Total N. (g/kg)	0.98	0.7	0.28
Exchangeable cations (emol)	10.03	8.36	9.13

Table 2: Effect of Sowing Date on percentage (%) sesame seed emergence in Bauchi, during 2005, 2006, 2007 rainy seasons.

Treatments.	Years.		
	2005	2006	2007
Sowing Date (SD)			
30th June		96.66	96.88
15th July		96.77	96.44
30th July		96.33	97.33
LS		NS	NS
SE ±		0.48	0-37

The results presented above on the effect of sowing date on sesame seed emergence clearly showed that sowing date had no significant effect on sesame seed emergence all through the period of the investigation.

Table 3: Effect of Sowing Date on the Plant Height (cm) of Sesame at 4, 6, 8 and 10 weeks after emergence (WAE) at Bauchi during 2005 rainy season

Treatments	Weeks after emergence (WAE).			
	4	6	8	10
Sowing Date (SD)				
30th June	15.91	46.57	79.34a	111.0a

**Effect of Sowing Dates on some Growth and Yield Parameters of Benniseed
(*Sesamum indicum*) as Produced in Bauchi, Bauchi State, Nigeria**

16th July	13.24	46.22	87.64a	101.70ab
30th July		12.16	37.71	71.38b
LS	NS	NS	*	**
SE ±	1.49	3.38		

The analyzed results obtained from the Effect of Sowing Date on Sesame plant height (cm) during the 2005 cropping season, showed sowing date having significant on plant height only at 8 and 10 weeks after emergence of the study period.

Table 4: Effect of Sowing Date on the Plant Height (cm) of sesame at 4, 6, 8 and 10 weeks after emergence (WAE) at Bauchi, during 2006 rainy season

Treatments	Weeks after emergence (WAE)			
	4	6	8	10
Sowing Date (SD)				
30th June		28.02b	67.14b	103.16
16th July	36.76a	86.26a	91.38	127.71a
30th July		36.98a	61.47b	78.57
LS		**	**	NS
SE ±				11.63

The results obtained and analyzed as per the effect of sowing date on sesame plant height (cm) in 2006 cropping season showed sowing date having statistically significant effect at 4, 6 and 10 weeks after emergence period of the study.

Table 5: Effect of Sowing Date on the Plant Height of Sesame at 4, 6, 8 and 10 weeks after emergence (WAE) in Bauchi during 2007 rainy season

Treatment	Weeks after emergence (WAE).			
	4	6	8	10
Sowing Date (SD)				
30th June		11.39	27.70	53.18b
16th July	11.77		26.27	48.82b
30th July		12.72	31.72	73.06a
LS	NS	NS	*	NS
SE ±	1.71	3.84		6.63

Results obtained and analyzed from the effect of sowing date on sesame plant height (cm) in 2007 cropping season, showed sowing date having significant effect on sesame plant height only at 8 weeks after emergence of the period of investigation.

Table 6: Effect of Sowing Date on the Leaf Area of Sesame at 4, 6, 8, 10 after emergences (WAE) Bauchi during 2006 rainy season

Weeks after emergence (WAE).



Treatments	4	6	8	10
Sowing Date (SD)				
30th June		39.45	49.22a	31.05a
15th July	25.75	43.23a	24.38a	14.70b
30th July		23.311	22.64b	14.01b
LS		NS	**	**
SE ±		6.47		*

Statistically sowing date within the period of the study (2005) had significant effect on sesame leaf area (cm^2) at 6, 8 and 10 weeks after emergence.

Table 7: Effects of Sowing Date on the Leaf Area of sesame at 4, 6, 8 and 10 (WAE) at Bauchi during 2006 rainy season.

Treatments	Weeks after emergence (WAE).			
	4	6	8	10
Sowing Date (SD)				
30th June		47.16a	3.04a	23.63a
15th July	44.30b	36.76a	17.77ab	7.42b
30th July		26.29b	13.00b	14.11b
LS		**	**	**

The effect of sowing date on sesame leaf area (cm^2) as observed and analyzed during 2006 study period indicated sowing date had high significant effect on sesame leaf area all through the period of the study.

Table 8: Effect of Sowing Date on the Leaf Area of Sesame at 4, 6, 8 and 10 weeks after emergence (WAE) at Bauchi during 2007 rainy season.

Treatments	Weeks after emergence (WAE).			
	4	6	8	10
Sowing Date (SD)				
30th June		11.79	18.56	24.07a
15th July	15.40	17.38	11.91b	9.72b
30th July		13.93	12.15	8.32b
LS		NS	NS	*
SE ±		2.85	1.80	**

The effect of sowing date on sesame leaf area (cm^2) in 2007 cropping season was only statistically significant at 8 and 10 weeks after emergence period of the study.

Table 9: Effect of Sowing Date on the Number of Capsules per plant of sesame at 8 and 10 weeks after emergence (WAE) in Bauchi during 2006 rainy season

Effect of Sowing Dates on some Growth and Yield Parameters of Bennisseed (*Sesamum indicum*) as Produced in Bauchi, Bauchi State, Nigeria

Treatments	Weeks after germination (WAE).	
	8	10
Sowing Date (SD)		
30th June	24.11a	49.44b
15th July	19.33ab	61.77a
30th July	17.77b	43.00b
LS	*	**

Sowing date had high significant effect on sesame number of capsule per plant all through the period of the study.

Table 10: Effect Sowing Date on the Number of Capsules per plant of sesame at 8 and 10 weeks after emergence (WAE) at Bauchi during 2006 rainy season

Treatments	Weeks after germination (WAE).	
	8	10
Sowing Date (SD)		
30th June	37.00ab	90.66a
15th July	19.33b	86.66a
30th July	46.66a	44.67b
LS	*	**

Sowing date had high significant effect on sesame number of capsule per plant all through the period of the study (2006)

Table 11: Effect of Sowing Date on Number of Capsules per plant of sesame at 8 and 10 weeks after emergence (WAE) at Bauchi during 2007 rainy season

Treatment	Weeks after germination (WAE).	
	8	10
Sowing Date (SD)		
30th June	5.66b	13.11ab
15th July	4.00b	9.44b
30th July	18.44a	22.11a
LS	**	*

Sowing date had high significant effect on sesame number of capsule per plant during 2007 cropping season.

Table 12: Effects of Sowing Date on 1000 Seed Weight (g) of sesame as produced in Bauchi during 2005, 2006, 2007 rainy seasons.

Treatments	Years		
	2005	2006	2007
Sowing Date (SD)			



30th June		1.63	1.91	1.05b
15th July	1.96	2.02	1.68a	
30th July		1.80	2.03	1.69a
LS		NS	NS	**
SE ±		0.11	0.03	0.002

The effect of sowing dates was found to be significant in affecting in 1000 seed weight in the 2007 season only.

**Effect of Sowing Dates on some Growth and Yield Parameters of Bennisseed
(*Sesamum indicum*) as Produced in Bauchi, Bauchi State, Nigeria**

Table 13: Effects of Sowing Date on sesame seed yield (Kg/ha) in Bauchi during 2006, 2006, 2007 rainy seasons.

Treatments	Years		
	2005	2006	2007
Sowing Date (SD)			
30th June	1580.74	559.01a	176.19
15th July	3041.97	458.96ab	191.72
30th July	1061.73	257.97b	196.04
LS	NS	*	NS
SE ±	814.5	78.59	35.20

DISCUSSIONS

Results obtained from the effect of sowing dates on percentage seed germination in year 2006, 2006 and 2007 study period showed non significant effect all through the period of the investigations. The results obtained might be linked with the quality of seed used, its purity along with good and well spread rainfall received during sowing period of the research, optimum temperature and photoperiod experienced within the period of the study, all of these factors might have encouraged vigorous and high percent seed germination.

Sowing date was observed to have had significant effect on sesame plant height at 8 and 10 weeks after emergence in 2005 season, while in 2006 it was significant at 4, 6 and 10 weeks after emergence with crops sown on 15th of July and 30th of July producing similarly taller plants than sesame sown on 30th of June, while at 6 weeks after emergence (WAE), sesame sown on 15th of July produced significantly taller plants with a mean value of (85.26cm) than those sown on 30th of June and 30th of July, with mean plant heights of 67.14, 61.47cm respectively. At this stage it also produced plant that was shorter in height. On the other hand sowing sesame on 30th of June and 15th of July at 10 weeks after emergence in 2006 season significantly produced plant populations that were taller with heights of, 123.50, 127.71 cm respectively, compared to those sown on 30th of July (96.60cm). The result obtained above could still be linked to the purity of seeds used, as subjected to different sowing dates which was consistent in most its morphological characteristics all through the period of the study. Coupled with other factors such as ; safety of the seeds when sown at even depth (5cm), well prepared soil with good soil moisture level, possibly giving room to high percent(%) seed germination. Other factors could be good crop establishment, prompt weeding and thinning to optimum plant density as early as at two weeks after emergence. As earlier on reported by Olowe, (2004) that growth habit in sesame is generally is indeterminate, and his further observation and report in (2007) which indicated that variation in sowing date had significant effect on performance of Yandev'55 an improved high yielding variety in Nigeria as sown in south west Nigeria by mid and late July and August as early and late season crops of which crops sown in early and mid July elongated faster, than one sown in August

Sowing date at 6, 8 and 10 WAE in year 2005 season had significant effect on sesame leaf area (cm²), with crops sown on 30th June and 15th of July significantly producing higher leaf area (cm²) than crops sown on 30th of July which was observed producing significantly lower leaf area (cm²). The above result might be linked to the fact that early sown crops 30th June and 15th July might have enjoyed more favourable weather conditions such as high temperature due to free incoming solar radiation as a result of lee cloud cover in the study area a characteristics of tropical climate at its early stage of rainfall. Along with these could be good aeration around the young developing roots, good soil nutrient present at early rainfall periods, available soil moisture, which had earlier on contributed to good seed emergence, good crop establishment hence good leaf area development. While the late sown crop, 30th of July might have suffered some set back due to heavy rains experienced within this period of the study in the research area, which might have led to



reduction in the rate of air circulation in the root zone of the crop. Heavy down pour within short duration of fall could also have led to the possible leaching of the available N hence poor nutrient status subsequently leading to possibly poor photosynthesis thereby manifesting in plants with smaller leaf area development compared to the leaf area (cm^2) of early sown crops within the cropping season.

Sowing date also had significant effect on number of capsules per plant at both 8 and 10 WAE in the 2006 cropping season. At 8 WAE crops sown on 30th of July significantly produced crops giving higher number of capsules per plant (46.66) than crops sown on 30th of June and 15th July, with 37.00 and 19.33 numbers of capsules per plant respectively. At 10 WAE crops sown on 30th June (early sown) produced significantly higher number of capsules per plant (90.56) than number of capsules observed from crops sown on 15th July and 30th July, mid and late sown sesame produce significantly lower number (86.66 and 44.67) respectively. Part of the likely reasons for this results obtained within the period of the investigation might be the timely thinning of the seedlings at 2 WAE leading probably to an optimum crop density, thereby reducing inter and intra specific competition for water, light and space among crop plants. This finding seem to be in agreement with an earlier report by Robbelen (1989), that plant population has direct influence on the number of capsules per plant of which high plant population or close spacing in row tends to reduce both number of capsules and number of seeds per plant, he also opined that number of capsules per plant is directly related to the number of fertilized flowers, and that prevailing climatic conditions could affect the percentage of fertilized flowers.

Sowing date had significant effect on 10000 seed weight(g) only during the 2007 season, with crops sown on 15th July and 30th July producing crops with significantly similar 1000 seed weight (1.68 & 1.69 g), which was significantly higher than the 1000 seed weight (1.05g) of crops sown on 30th June. Sowing date did not have significant effect on 1000 seed weight (g) on crops produced during the 2005 and 2006 seasons. The findings could be related to possible adaptability of the varieties under investigation to environmental factors such as proper cultivation of the soil before sowing seeds, seed sowing depth (5cm) which was lightly covered with fine sand on a moist soil aiding in high percent seed emergence, good seedling establishment which was properly thinned at 2WAE creating room for fair access to water, nutrient, sunlight, hence good vegetative growth and better reproductive development. As earlier on observed and reported by Adelrahman *et al.*, 2007, that sowing date had significant effect on 1000 seed weight on crops sown in early July which produced plant with heaviest 1000 seed weight than other sowing dates observed

The effect of sowing date on seed yield within the period of three years investigation was observed to be significant only in 2006 season, of which crops sown on 30th June and 15th of July produced significantly similar higher seed yield (559.01 and 458.96 kg/ha), than seed yield obtained from crops sown on 30th of July (257.97) which was significantly lower within the period of the investigation. Possible contributory factors to significant effect on seed yield obtained could be; number of branches per plant, number of capsules per plant which both have direct link to number of seeds in a capsule and its final seed yield. Olowe, (2007) also opined that adequate moisture in the soil enhanced enlargement of sesame seeds and subsequently increased sesame grain yield. The results obtained also agreed with previous results reported by Olowe and Busari (2003) in which seed yield obtained from early and mid sown sesame, variety E-8 (early July, mid August) were higher than those planted later. (late August). Khaskeli, (2009) also reported significant effect of different sowing dates on yield and yield related characters of two sesame varieties S-17 and Pr-19 with sesame sown on 1st May giving highest yield of 1137.59kg/ha than crops sown on 15th May, 1st June and 15th June.

It is therefore recommended that sesame producers in the study area despite dwindling rainfall establishment should endeavour to sow their sesame as soon as the rains establishes. Care must be taken to sow only when soil moisture content is high enough to encourage good and quick seed germination, subsequently good seedling establishment and good seed yield

**Effect of Sowing Dates on some Growth and Yield Parameters of Bennisseed
(*Sesamum indicum*) as Produced in Bauchi, Bauchi State, Nigeria**

REFERENCES

- Abdel Rahaman, A. Saif Eldin M.E. Faisal G.A.(2007) Effect of Sowing date on the Performance of Sesame (*Sesamum indicum* L.) genotypes under irrigation conditions in northern Sudan. African Crop Science Conference Proceedings Vol 8: 1943-1946
- CHEMONICS INTERNATIONAL INC (2002) Overview of the Nigerian Sesame Industry. The United States Agency for International Development (USAID) Nigeria Raise IQC Contract NoPCE-100-99-00003-00.Task Order No.812.pp16-18
- Khaskeli, I.A.(2009) Effect of different Sowing Dates on the Growth and Yield of Different Varieties of Sesame (*Sesamum indicum* L.)Abstract <http://agris.fao.org/aos/records/PK2011000062>
- Naturaland e-V. (2002) Organic Farming in the Tropics and Subtropics, Exemplary Description of 20 crops sesame.Pp1-41.
- Olowe, V.I.O. and Busari I D (2003) Growth and grain Yield of Two sesame (*Sesamum indicum* L.) Varieties as affected by Row Spacing in Southern Guinea savannah of Nigeria *Samaru Journal of Agricultural Research* 19:91-100.
- Olowe, V.I.O (2004) Production Potential for Sesame in the Forest Savannah Transition Zone of South West Nigeria .*MUARRIK BULLETING* 7:20-29. Printed in Uganda.
- Olowe, V.I.O.(2007)Optimum Date for Sesame (*Sesamum indicum* L.) In The Transition Zone of South West Nigeria. *Agricultura Tropica et Subtropica* Vlo. 40(4)2007 166
- Protabase Record (2011) Prota 14: Vegetable oils Record Display.mhtml:file:/\| bola2| Record.mhu. 1-12
- Robbelen, G. Downey, R.K. Ashri,A.(1989) Oil Crops of the world. Macgrow publishing company NewYork pp376-379
- Salako, E.A. and Falusi O.A (2004) Plant Genetic Resources NewsletterAssemblage of sesame germplasm for coser http://www.ipgri.cgiar.org/pgrnews/ette/article.asp?id_article==23&id_Issue=127 Pp 1 of 3



Reawakening the Agricultural Sector through Government Expenditure for Sustainable Growth in Nigeria (2000-2020)

Jimmy, Vincent Gambo and Mr Goluwa, Shadrack Ezekiel

Department of Economics

Plateau State University Boko.

Email: vincentgambo@gmail.com

ABSTRACT

The paper attempts to expound on Reawakening the Agricultural Sector through Government Expenditure for Sustainable Growth in Nigeria (2000-2020). The differenced Ordinary Least Square (OLS) method was used after it was discovered that there was no cointegration in the model. The findings of the study reveal that Government Expenditure on Agriculture and Agricultural Output impacts positively on sustainable economic growth significantly. This means that Government Expenditure on Agriculture and Agricultural Output have helped the economy to achieve significant growth from 2000 to 2020. Therefore the study concluded that growth has been achieved due to the contributions of Government Expenditure on Agriculture and Agricultural Output in the Nigerian economy. The study recommended that Government should increase its level of expenditure to the agricultural sector, thereby providing more funding in the sector to raise its productivity and increase its contribution to economic growth in Nigeria.

Key words: Agricultural Sector, Sustainable growth.

INTRODUCTION

Agriculture composed of crop production, livestock, forestry and fishing. The agricultural sector has the potential to be the industrial and economic springboard from which a country's development can take off. It is well established that economies defined themselves by the process and extent to which they have succeeded in improving the productive capacity of agricultural sector. In the Nigerian context, the most wide spread and effective far-reaching improvement in agricultural production has been to expand the area of land planted. For this reason, Nigerian agricultural/rural institution are in dilemma with little prospect of growing at sustaining level. Nigeria is generously endowed with abundant natural resources. With its reserves of human and natural resources, Nigeria has the potential to build a prosperous economy and provide for the basic needs of the population. This enormous resource base if well managed could support a vibrant agricultural sector capable of ensuring the supply of raw materials for the industrial sector as well as providing gainful employment for the teeming population (Ukeje 2002). Agriculture involves the cultivation of land, raising and rearing of animals for the purpose of production of food for man feed, and raw materials for industries (Ebomche, 2010). Despite its contributions to the economy over the years, the federal government allocated a small fraction of the total budget to the sector. Most allocation ended up in the recurrent expenditure living a fraction of capital expenditure.

Public spending (e.g. Budget) is one of the most direct effective instruments used by governments to promote agricultural growth and poverty reduction. (Ukeje 2002). Public spending at the federal level and sub-national level follows a basic structure-recurrent spending and capital spending. This spending structure is characterized by different expenditure categories depending on the ministry, department or agency. The nature of support given to agriculture by various governments in the

country varied over the years. Before independence, the assistance to the sector was generally aimed at developing the export crops required by the overseas industries. After independence when the national development plans were prepared, agricultural support took a much formal form, and thus presented a more serious impression of what government intended doing for the sector. However what most of the efforts later turned out to be as can be inferred from the allocations made in the various national development plans and annual budgets, leave much to be desired. When compared to other sectors like mining, manufacturing, education, and health, agriculture virtually received the least annual allocations that are often inadequate to put the sector on sustainable grounds. This accounts to a large extent for the poor performance of many institutional reforms and strengthening which were over the years undertaken in the sector (Nwajiuba, 2012).

Furthermore, government over the years has embarked on various policies and programmes aimed at strengthening the sector in order to continue performing its roles, as well as measures for combating poverty. Notable among these policies are the Operation Feed the Nation (OFN), programme was launched with objectives of increasing food production, attaining self-sufficiency in food supply and encouraging all sections of the Nigerian population to grow food, encouraging balanced nutrition and by extension of a healthy nation, Green Revolution Programme (GR) was established in 1980 by the civilian regime aimed at wiping away hunger through credit supply to farmers, encourage and intensify cooperative education, mobilizing the local people to actively participate in agriculture, application of research on food and fiber to enhance abundance in staple food production, processing and distribution in Nigeria. Land Use Decree which was promulgated in 1978 in order to first effect structural change in the system of land tenure; secondly, to achieve fast economic and social transformation; thirdly, to negate economic inequality caused by the appropriation of rising land values by land speculators and land holders; and lastly to make land available easily and cheaply, to both the government and private individual developers. The focus of the Decree was to reform the land tenure system, which was believed to constitute a formidable obstacle to the development of agriculture in Nigeria. Rural Banking Programme, (RBP) also established in 1977 to 1991. Banks were encouraged not to only establish rural branches but also to extend at least 50 per cent of the deposit mobilized from the rural areas as loans and advances to rural dwellers. Defaulting banks were to be penalized. National FADAMA Development Programme aimed at increasing income of beneficiaries by at least 20%. The programme was designed in 1993 to promote simple and low cost improved irrigation technology under World Bank financing. Family Economic Advancement Programme (FEAP), 1997 to 2001. This was established to serve the credit needs of the family in their daily economic activities through input supplies, loan in form of cash, and capacity building. National Poverty Eradication Programme (NAPEP), 1999 to date. Like FEAP, NAPEP was established by the federal government. The mode of operation is tailored towards directed (subsidized) credit to farmers.

Average total annual expenditure on agriculture, has been increasing over the years. The President Mohammadu Buhari led government Economic Recovery and Growth Plan (ERGP) preached inclusive growth through diversification of production, achieving maximum welfare for the citizens by ensuring food and energy security. The government had plan to use agriculture as a lever to achieve food



security, create jobs, and save foreign exchange for import. To achieve this, the federal government increased budgetary allocation to the sector by three digits trillions for the first time in 2017, (Aderemi 2020). In that year President Buhari's government allocated ₦136.6 billion to the sector. In 2018 and 2019, the figures increase to ₦203bn and ₦137.9 billion respectively (CBN 2020). Despite these huge sums of money allocated to the sector over the years, the state of agriculture in Nigeria still remains poor and largely underdeveloped. The poor state of the sector has been blamed on oil glut and its consequences on several occasions, as this pattern was not an outcome of increased productivity in the non-agricultural sectors as expected of the industrialization process; rather it was the result of low productivity due to negligence of the agriculture sector (Anzaku, 2014). Also, a large degree of change in agricultural output is accounted for by change in budgetary allocation to agricultural sector. Thus, budgetary allocation to agriculture has a large impact on agricultural output.

STATEMENT OF THE PROBLEM

Prior to the discovery of oil in the late 1950s and early 1960s, agriculture was the dominant sector of Nigeria's economy. It consisted over 65 per cent of the country's Gross Domestic Product (GDP) and provided the bulk of the foreign exchange earnings through the export of cash crops. But with the emergence of oil as a major source of government revenue and exchange earning, the sector was neglected and hence led to its decline in output (Iwagemi 1994). Having realized the declining of agriculture output, government over the years has put in place certain policy measures and programmes with a view to increasing the output. However a peep into the Federal Government capital expenditure on agriculture; as a ratio of the total Federal Government capital expenditure shows a gloomy future for sector development in the country. As from 1977 to 2002, the federal government capital expenditure on agriculture were low except in the following years; 1980, 1984, 1987, 1988, 1993, 1994, 19 and 2002, (Statistical bulletin 2004), because those were the years that coincides with different government agricultural development policies and programmes such as the Green Revolution in 1980, Food for all Programme in 1987, the Better Life for Rural Women Programme also in 1987, the Family Support Programme in 1993 and the Economic Empowerment Development Strategy. Overtime, this expenditure has been on agriculture without expressly translating to a corresponding agricultural output. Therefore the interest of this research work is to investigate reawakening the Agricultural sector through Government Expenditure for sustainable growth in Nigeria from 2000 - 2020.

THE LITERATURE

Ogieva & Osaji (2018) defined agriculture as the art and science of cultivating the soil, producing livestock, preparing livestock feeds, processing crops and livestock. It is a deliberate attempt by a man to cultivate crops, rear animals, caring for them for the benefit he will get from doing so. Moreover, it embraces various preparations and processes of plant and animal products as well as the disposal of these products through marketing. Thus, agricultural production in Nigeria is dominated by small-scale farms characterized by small, uneconomic and often fragmented holdings, the use of simple

implements (Hoes and Cutlasses) and unimproved planting and storage materials. The results have been a viscous web of low productivity, low income and low capital investment.

According to Anna, Karolina, Jarostaw, & Jerzy (2017). Agriculture is a way of life that involves production of animals, fishes, crops, forest resources for the consumption of man and supplying the agro-allied product required by our sectors. It is seen as the inherited and dominant occupation employing about 70% of Nigerians. Though, subsistence agriculture is practiced in this part of the world, it will not be an overstatement to say that it is the life-wire of the economies of developing countries. Conceptually, agriculture is the production of food, feed, fiber and other goods by the systematic growing and harvesting of plants and rearing of animals. It is the science of making use of the land to raise plants and animals. It is the simplification of nature's food webs and the rechanneling of energy for human planting and animal consumption (Akinbogo 2008). Until the exploitation of oil reserves began in the 1980s, Nigeria's economy was largely dependent on agriculture.

Government expenditure is referred to as the outflow of resources from government to other sectors of the economy (Nurudeen and Usman 2010). Government spending or public spending is sub-divided into current and capital expenditure. Capital expenditure has been defined as payment for non-financial assets used in production while current expenditures are payments for non-repayable transactions within a year, (CBN, 2003).

THEORETICAL LITERATURE

The Keynesian theory is adopted as the framework of this study. Keynes regards public expenditures as an exogenous factor which can be utilized as a policy instruments to enhance output. According to the Keynesian school of thought, increase in government spending leads to a multiple increase in total output of an economy (Shingan, 2010). This according to Keynes is the multiplier effect of government expenditure.

$$Y = C + I + G (X-M) \text{-----} 2.1$$

Where; Y = Output, C = Consumption, I = Investment, G = Government Expenditure, X-M = Net Export (export minus Import). The change in output will be equal to the multiplier times the change in government expenditure.

$$\Delta Y = k (\Delta G) \text{-----} 2.2$$

1-b

Where = $k = \frac{1}{1-b}$

1-b

$$\Delta Y = k \Delta G$$

Therefore, change in output all over change in government expenditure is equal to the multiplier.

$$\frac{\Delta Y}{\Delta G} = k \text{-----} 2.3$$

ΔG



Hence, expansionary fiscal policy can be used to influence macroeconomic performance and hence increase output growth. This theory suggests that government spending can contribute positively to sectorial growth (like the agricultural sector) in an economy.

Ewubare and Egitope (2016) examined the effects of government spending on the agricultural sector in Nigeria. The ordinary least square of multiple regressions, the Johansson co-integration techniques, and the error correction model were used for the analysis. The results showed that the coefficient of determination is 0.9468 and the coefficient of the Error Correction Model (ECM) appeared with negative sign and statistically significant. The lag two and three forms of the explanatory variable, government expenditure on agriculture (GEA) were positive and statistically significant. Based on the above findings, the study recommends for an increase funding of the agricultural sector in Nigeria.

FAO (2008) reported that in terms of capital allocation to agriculture in Nigeria, it was an average of 4.74 percent from 1970-1980. But, from 1980-2000, it rose to 7.00 percent and 10 percent from 2001-2011, though revealing an increase, but still falls short of Food and Agricultural Organization (FAO) recommendation that 25 percent of government capital budget be assigned to the agricultural development capital budget.

Francis (2013) examined the impact of Federal Government's expenditure on agricultural sector. He used a Simple regression with the view of analyzing the data which indicated the impact of agricultural expenditure on its output from 1991 to 2010. The R² was 1% indicating a weak relationship between the variables as a result of inadequate funding. He recommended that government should reinforce its budgetary allocations to the agricultural sector, ensure proper release of funds, monitor agricultural inputs distribution to farmers and create commodity markets.

The study carried out by Akintunde, Adesope and Okoruwa (2013) on the effectiveness of government annual budgetary allocation to agriculture and the role of monetary policy instruments in the growth of agricultural GDP in Nigeria using the OLS technique shows that Agricultural Credit Guarantee Scheme Fund, previous year GDP and Consumer Price Index contributed positively to the growth of agricultural GDP, other variables of interest like the interest rate, exchange rate, and government expenditure on agriculture contributed negatively to agricultural GDP growth. The study therefore recommended that government should increase her spending to agricultural sector, monitor the fund allocated, and provide the necessary infrastructural facilities like good road network, electricity health and water for the rural populace. Analyzing the relationship between Nigeria government expenditure on the agricultural sector and its contribution to economic growth, Okezie, Nwosu and Njoku (2013) employed the Engle-Granger two step modelling (EGM) procedure to co-integration based on unrestricted Error Correction Model and Pair wise Granger Causality tests. They found that agricultural contribution to GDP (Gross Domestic Product) and total government expenditure on agriculture are co-integrated. The speed of adjustment to equilibrium was 88% within a year when the variables wander away from their equilibrium values. Based on the result of granger causality, the paper concludes that a very weak causality exists between the two variables used in this study and that any reduction in government expenditure on agriculture would have a negative repercussion on

economic growth in Nigeria. Using time series data, Lawal (2011) attempted to verify the amount of federal government expenditure on Agriculture in the thirty-year period 1979 – 2007. Significant statistical evidence obtained from the analysis showed that government spending does not follow a regular pattern and that the contribution of the agricultural sector to the GDP is in direct relationship with government funding to the sector. Oboh (2008) used error correction model to investigate Farmers' allocative behavior in credit utilization in Benue State. The study reveals that the usefulness of any agricultural credit programme does not only depend on its availability, accessibility and affordability, but also on its proper and efficient allocation and utilization for intended uses by beneficiaries. Iganiga and Unemhilin. (2011) examined the impact of federal government agricultural expenditure on agricultural output in Nigeria. The study covers the period 1970 to 2008 employing the ECM technique. Their findings show that the federal government capital expenditure was positively related to agricultural output.

However, with one year lag period, it showed that the impact of government expenditure on agriculture is not instantaneous. Though the study observed that the investment in agricultural sector is imperative and that it should be complemented with monitored credit facilities, and food importation should be banned to encourage local producers. Adekanye (2005) used panel data threshold to examine the role of banks on the growth of Nigerian economy. The study observed that in making credit available, banks are rendering a great social service, because through their actions, production is increased, capital investment are expanded and a higher standard of living is realized. Ghosh (2007) made use of the heterogeneous panel data to study the impact of government expenditure on economic growth. Their results suggest that countries with large government expenditure tend to experience higher economic growth. This study is unique from other study in the area of the choice of explanatory variables. Udoh (2011) examined the relationship between public expenditure, private investment and agricultural output growth in Nigeria over the period 1970-2008. The bounds test and Auto regressive distributed lag (ARDL) modeling approach was used to analyze both short-run and long-run impacts of public expenditure, private investment (both domestic investment and foreign direct investment) on agricultural output growth in Nigeria. Results of the error correction model showed that public expenditure has a positive influence on the growth of agricultural output. However, foreign investment as insignificant impact in the short run. Hence, it is recommended that policymakers should combine both private and public investment in a complementary manner to ensure that both short-run and long-run productivity of the agricultural sector is not undermined. FAO (2008) reported that in terms of capital allocation to agriculture in Nigeria, it was an average of 4.74 percent from 1970-1980. But, from 1980-2000, it rose to 7.00 percent and 10 per cent from 2001-2007, though revealing an increase, but still falls short of Food and Agricultural organization (FAO) recommendation that 25 percent of government capital budget be assigned to the agricultural development capital budget. Okene (2001) in his work on the impact of government budgetary expenditure on agricultural output in Nigeria adopted a single equation regression model to verify the relationship between agricultural output and policy instrument in Nigeria and he concluded that government expenditure on agricultural output is statistically significant. Thought funds allocated to the agricultural sector in the budget do not commensurate



with the trend of expenditure in the economy. Oboh and Ekpebu (2010) used ordinary least square to examine the determinants of formal agricultural credit allocation to the farm sector in Nigeria. The study found out that there is the need to critically assess factors affecting the rate of credit allocation by beneficiaries of NACRDB. Akintola (2004) used autocorrelation to carry out a study on the role of banking industry in financing agriculture. He identified banks' traditional roles to include financing of agriculture sectors of the economy. Credit of banks to the Nigerian economy has been increasing over the years. Unlike other study, this study intends to employ a combination of explanatory variables to check the impact of both core and checked variables on the dependent variable.

METHODOLOGY

In this research work, the technique used in this analysis is the differenced Ordinary Least Square (OLS) method after it was discovered that there was no cointegration in the model. It is commonly used in estimating linear relationships in econometric methods because of its Best Linear Unbiased Estimator (BLUE) properties. In specifying the model for this study, the estimation equation includes GDP as dependent variable with EXPA, TAR and PAO as independent variables.

The mathematical form of the model is stated below :

$$GDP = f(EXPA, TAR, AO) \text{ (1)}$$

The Econometrical form of the model is stated below :

$$GDP = b_0 + b_1 EXPA + b_2 TAR + b_3 AO + u_t \text{ (2)}$$

From the equations above,

GDP- Gross domestic product is expressed as the dependant variable while the independent variables are

EXPA- Government Expenditure to Agriculture

TAR- Total Amount of Rainfall

AO- Agricultural Output.

u_t is the stochastic disturbance term. It captures the other variables not specified in the model.

RESULTS AND DISCUSSIONS

The Augmented-Dickey Fuller (ADF) unit root test was applied. This is to authenticate the level of stationarity of the data. The results are presented in table 2.

Table 1: Augmented Dickey-Fuller(ADF) Unit Root Test results

Variable	ADF Value	5%critical value	Stationarity level
LOGGDP	-2.71	-1.96	I(1)
LOGTAR	-3.97	-3.02	I(0)
LOGEXPA	-6.40	-3.02	I(1)
LOGAO	-4.96	-3.67	I(0)

Source: Eviews 10 Output

The table above shows the results of the unit root test for the variables used in the study. The results from the stationarity test show that while the log of Gross Domestic Products and log of Government

Expenditure on Agriculture were stationary at first difference, log of Total amount of rainfall and log of Agricultural Output where stationary at levels.

Co-integration Test

ARDL boundstesting approach is a co-integration test method developed by Pesaran, Shin and Smith (2001) to test for the presence of the long run relationship between the variables. The test was conducted and the results are presented in table 2.

The decision rule states that:

1. If the calculated F statistic is greater than the critical value for the upper bound I(1), then there is cointegration.
2. If the calculated F statistic falls below the critical value for the lower bound I(0), then there is no cointegration.
3. If the calculated F statistic falls between the critical values for the lower and upper bounds, then the test is inconclusive.

The result has revealed that there was no cointegration in the model. This is because the obtained F statistics value 2.24 was less than the critical value of the upper bound at 5% level of significance (4.30).

Table 2: Co-integration Test results

Test Statistic	Value	k
F-Statistic	2.24	3
Critical value Bounds.		
Significance Level	I(0)Bound	I(1)Bound
10%	2.67	3.68
5%	3.27	4.30
1%	4.61	6.96

Source: Authors computation using Eviews 10

Table 3: Differenced OLS Results

Variable	Coefficient	Std. Error	t-Statistic	Prob.
LOGEXPA	1.17	0.64	2.17	0.04
LOGTAR	0.06	0.03	1.96	0.03
LOGAO	0.20	0.01	1.19	0.02
C	18.061623	0.32		

$0.762=0.61$

Source: Authors computation using Eviews 10

From table 3 above, it can be seen that the intercept or constant term was obtained to be 18.06. This implies that the log of Real Gross Domestic Products will have this value even if the independent variables (log of Government Expenditure on Agriculture, log of Total amount of rainfall and log of Agricultural Output) assume the values of zero. The coefficient of the log of Government Expenditure on Agriculture (1.17) was positive and statistically significant at 5% to economic growth in Nigeria. This means that Government Expenditure on Agriculture contributes positively to Gross Domestic Products and that 1 percent increase in Trade Openness will lead to a 117 percentage increase in Gross Domestic Products.



The coefficient of the log of Total amount of rainfall (0.06) was positive and statistically significant at 5% to economic growth in Nigeria. This means that Total amount of rainfall contributes positively to Gross Domestic Products and that 1 percent increase in Total amount of rainfall will lead to a 6 percentage increase in Gross Domestic Products. The coefficient of the log of Agricultural Output (0.20) was positive and statistically significant at 5% to economic growth in Nigeria. This means that Agricultural Output contributes positively to Gross Domestic Products and that 1 percent increase in Agricultural output will lead to a 20 percentage increase in Gross Domestic Products. The R^2 obtained was 0.64 which shows the model has a good fit. It also implies that 64% of the variations in the dependent variable (GDP, Gross Domestic Products) are explained by the independent variables (Government Expenditure on Agriculture, Total amount of rainfall and Agricultural Output). While 36% of the variations in the model are explained by other variables that contribute to economic growth but were not captured in this model.

POST ESTIMATION DIAGNOSTIC TEST RESULTS

Autocorrelation Test

From table 4 below, it can be seen that the P-value of the Breusch-Godfrey serial correlation LM test is 0.13 which is greater than the level of significance of 0.05. This implies that there is no autocorrelation in the model

Table 4: Autocorrelation Test results

Breusch-Godfrey Test:	Serial Correlation	LM
2.343144 Prob. F(2,14)	0.1326	
6.016761 Prob. Chi-Square(2)	0.0814	

Source: Authors computation using Eviews 10

Test for Heteroscedasticity

From table 10 below, it can be seen that the P-value of the Breusch-Pagan-Godfrey test 0.84 is greater than 0.05. This implies that there is no Heteroskedasticity in the model.

Table 5: Heteroscedasticity Test Results

Heteroskedasticity Test: Breusch-Pagan Godfrey			
F-statistic	0.278179	Prob. F(3,16)	0.8403
Obs*R-squared	0.991469	Prob. Chi-Square(3)	0.8033
Scaled explained SS	0.676736	Prob. Chi-Square(3)	0.8787

Source: Authors computation using Eviews 10

MULTICOLLINEARITY TEST

Decision rule: When the uncentered VIF is greater than the ones beside it, then there is the presence of multicollinearity.

Table 6: Multicollinearity Test results

Variable	Coefficient Variance	Uncentered VIF		Centered VIF
D(TAR)		0.001182	1.321338	1.313409
D(AO)		0.000330	3.175413	1.319337
D(EXPA)		0.293563	1.046621	1.015766
C		203.0038	2.738176	NA

The table above shows that there is the presence of some level of Multicollinearity because the uncentered Variance Inflation Factors (VIF) is averagely greater than the ones beside it.

DISCUSSION OF FINDINGS

From the results, it was discovered that the coefficients for log of Government Expenditure was positive and statistically significant this leads to the conclusion that Government Expenditure on Agriculture has a significant impact on economic growth in Nigeria. The result is consistent with the work of Ewubare and Egitope (2015) who examined the effects of government spending on the agricultural sector in Nigeria. The lag two and three forms of the explanatory variable, government expenditure on agriculture (GEA) were also positive and statistically significant.

The result is consistent with the work of Lawal (2011) who used time series data and attempted to verify the impact of federal government expenditure on Agriculture in the thirty-year period 1979 – 2007. Significant statistical evidence obtained from the analysis showed that government spending does not follow a regular pattern and that the contribution of the agricultural sector to the GDP is in direct relationship with government funding to the sector. The results are consistent with Okene (2001), Oboh and Ekpebu (2010) and Iganiga and Unemhilin. (2011) who all examined the impact of federal government agricultural expenditure and agricultural output in Nigeria on Economic growth and found a positive relationship.

CONCLUSION AND RECOMMENDATIONS

This study's findings reveal that Government Expenditure on Agriculture and Agricultural Output impacts positively on economic growth significantly. This means that Government Expenditure on Agriculture and Agricultural Output have helped the economy to achieve significant growth from 2000 to 2020. Therefore the study concludes that growth has been achieved due to the contributions of Government Expenditure on Agriculture and Agricultural Output. The following recommendations are made based on the findings of the study.



1. Government should increase its level of expenditure to the agricultural sector, thereby providing more funding in the sector to raise its productivity and increase its contribution to economic growth in Nigeria.
2. The Central Bank of Nigeria should come out with stable policy guidelines to enable the commercial banks disburse loans to farmers at a very lower interest rate, in order to help them expand their production capacity
3. Government should ensure that it provides the facilities needed for dry season farming because the rainfall does not contribute significantly to Economic growth in Nigeria.
4. Government should come up with stringent policies to diversify the export base of the country. Because the over reliance on the crude oil sub sector is no longer yielding the desired results as a result of the volatility of crude oil prices in the international and the fact that the sector uses capital intensive processes which do not significantly support employment generation directly.

REFERENCE

- Adekange, J. B. (2006). *Reforming the character of civil-military relations for democratic governance in Nigeria after 1999 (No. 8)*. The Faculty of Social Sciences, University of Lagos.
- Aderemi, B. E. (2020). *Resuscitating agricultural production (cocoa, cotton, groundnuts, palm oil, rubber, etc) for exports*. In 10th Annual Conference of Zonal Research Unit of The Central Bank of Nigeria, held in Owerri.
- Akinboyo, O. L. (2008). Five decades of agricultural policies: What role has statistics played? *CBN Bullion*, 32(1), 134-166.
- Akintola, O. (2004). *A gendered analysis of the burden of care on family and volunteer caregivers in Uganda and South Africa*.
- Akintunde, Y. W., Adesope, A. A. A., & Okorwa, V. O. (2013). An analysis of federal government expenditure and monetary policy on agricultural output in Nigeria. *International Journal of Economics, Finance and Management Sciences*, 1(6), 310-317.
- Anzaku, E. (2014). The dutch disease and the non-oil sector: Is there still hope for Nigerias development. *Journal of Economics and allied fields*. 5(1)CBN (2003). *Central Bank of Nigeria Annual Report and Statement of Accounts for the Year ended 31st December 2003*
- Central Bank of Nigeria, (2020). *Annual Report and Statement of Accounts for the Year Ended 31st December 2020*.
- Christiaensen, L., & Demery, L. (2007). *Down to earth: agriculture and poverty reduction in Africa*. The World Bank
- DFID (U.K. Department for International Development). 2006. "Growth and Poverty Reduction: The Role of Agriculture." DFID Policy Paper. London: DFID. <http://www.dfid.gov.uk/pubs/files/growth-poverty-agriculture.pdf>. Accessed 12 August 2021.
- Ebouche, O. M. (2010). Improving the agricultural sector toward economic development and poverty reduction in Nigeria. *CBN Bullion*, 4, 23-56.
- Ewubare, D. B., & Egitope, J. A. (2015). The effects of public expenditure on agricultural production output in Nigeria. *Journal of Research in Humanities and Social Science*, 3(11), 07-23.

- Fao, F. A. O. S. T. A. T. (2008). *Food and agriculture organisation of the United Nations*. Retrieved on, 16.
- Fic, K., Lota, G., Meller, M., & Frackowiak, E. (2012). Novel insight into neutral medium as electrolyte for high-voltage supercapacitors. *Energy & Environmental Science*, 5(2), 5842-5850.
- Francis, R. (2013). *Report of the Mid Staffordshire NHS Foundation Trust public inquiry: executive summary (Vol. 947)*. The Stationery Office.
- Ghosh, S. (2007). The composition of government spending and growth: is current or capital spending better?. *Oxford Economic Papers*, 60(3), 484-516.
- Ihugba, O. A., Chinedu, N., & Njoku, A. C. (2013). An assessment of Nigeria expenditure on the agricultural sector: Its relationship with agricultural output (1980-2011). *Journal of economics and international finance*, 5(6), 177-186.
- Iwayemi, A., & Jerome, A. (1996). *Full employment strategy in Nigeria: A macroeconomic policy framework*. Towards Full Employment Strategy in Nigeria, 44.
- Shingan, M.L.(2010). *The Economics of Development and Planning*, New Delhi. Vrinda Publications(P) LTD.
- Lawal, W. A. (2011). An analysis of government spending on agricultural sector and its contribution to GDP in Nigeria. *International Journal of Business and Social Science*, 2(20).
- Momoh(2016). *Impact of Agricultural Services and Training Centres(ASTC) project on Tomato farmers Livelihood in Plateau State, Nigeria*. Unpublished PHD research thesis, Ahmadu Bello University (ABU) Zaria, Agricultural Extension and Rural Sociology.
- Nwajiuba, C. (2012). Nigeria's agriculture and food security challenges. Available on www.boell.org/downloads/4_Green_Deal_Nigeria_AGRICULTURE.pdf.
- Nurudeen, A. & Usman, A.(2010). Government Expenditure and Economic Growth in Nigeria, 1970-2008: A Disaggregated Analysis. *Business and Economics Journal*, Vol. 4, pp. 1 – 11.
- Oboh, G. (2008). Antioxidant properties of polar and non-polar extracts of some tropical green leafy vegetables. *Journal of the Science of Food and Agriculture*, 88(14), 2486-2492.
- Okene, O. V. C. (2001). Legislative Control of Freedom of Contract in Nigeria. *Modern Practice Journal of Finance and Investment Law*, 3(3).
- Pesaran, M. H., Shin, Y., & Smith, R.J. (2001). Bounds testing approaches to the analysis of level relationships. *Journal of Applied Economics* 16(3), 289-326
- Udoh, E. J. (2011). Estimation of loan default among beneficiaries of a state government owned agricultural loan scheme, Nigeria. *Journal of Central European Agriculture*, 9(2), 343-352.
- Ukeje, B. O. (2002). Financing education in Nigeria. *The Nigerian Social Scientist*, 5(1), 31-39.
- Okpong G.E. (1993). "Some Strategies for the Development of Nigeria's Agricultural Sector in 1990s", *CBN Economic and Financial Review*, vol 31 No2



APPENDIX

AO STATIONARY AT LEVEL

Null Hypothesis: AO has a unit root

Exogenous: Constant, Linear Trend

Lag Length: 1 (Automatic - based on SIC, maxlag=4)

		t-Statistic	Prob.*
Augmented Dickey-Fuller test statistic	-4.966868		0.0166
Test critical values:	1% level	-4.532698	
	5% level	-3.673616	
	10% level	-3.277364	

*MacKinnon (1996) one-sided p-values.

Augmented Dickey-Fuller Test Equation

Dependent Variable: D(AO)

Method: Least Squares

Date: 11/01/21 Time: 12:14

Sample (adjusted): 2002 2020

Included observations: 19 after adjustments

Variable	Coefficient	Std. Error	t-Statistic	Prob.
AO(-1)	-0.691477	0.162057	-4.266868	0.0007
D(AO(-1))	-0.148088	0.158562	-0.933942	0.3651
C	5213.086	846.6953	6.156979	0.0000
@TREND("2000")	393.4608	108.9976	3.609726	0.0026
R-squared	0.751638	Mean dependent var		669.8305
Adjusted R-squared	0.701966	S.D. dependent var		562.6946
S.E. of regression	307.1893	Akaike info criterion		14.47747
Sum squared resid	1415479.	Schwarz criterion		14.67630
Log likelihood	-133.5360	Hannan-Quinn criter.		14.51112
F-statistic	15.13188	Durbin-Watson stat		0.771774
Prob(F-statistic)	0.000083			

GDP STATIONARY AT FIRST DIFFERENCE

Null Hypothesis: $D(GDP)$ has a unit root

Exogenous: None

Lag Length: 0 (Automatic - based on SIC, maxlag=4)

	t-Statistic	Prob.*
Augmented Dickey-Fuller test statistic	-2.716897	0.0094
Test critical values:		
1% level	-2.692368	
5% level	-1.960171	
10% level	-1.607061	

*MacKinnon (1996) one-sided p-values.

Warning: Probabilities and critical values calculated for 20 observations and may not be accurate for a sample size of 19

Augmented Dickey-Fuller Test Equation

Dependent Variable: $D(GDP,2)$

Method: Least Squares

Date: 11/01/21 Time: 12:17

Sample (adjusted): 2002 2020

Included observations: 19 after adjustments

Variable	Coefficient	Std. Error	t-Statistic	Prob.
$D(GDP(-1))$	-0.689037	0.216806	-2.716897	0.0141
R-squared	0.290149	Mean dependent var		-1.581679
Adjusted R-squared	0.290149	S.D. dependent var		62.69436
S.E. of regression	44.39641	Akaike info criterion		10.47639
Sum squared resid	36478.76	Schwarz criterion		10.62610
Log likelihood	-98.51621	Hannan-Quinn criter.		10.48380
Durbin-Watson stat	1.947101			

TAR STATIONARY AT LEVELS

Null Hypothesis: TAR has a unit root

Exogenous: Constant

Lag Length: 0 (Automatic - based on SIC, maxlag=4)

	t-Statistic	Prob.*
Augmented Dickey-Fuller test statistic	-3.977611	0.0070
Test critical values:		
1% level	-3.808546	
5% level	-3.020686	
10% level	-2.650413	

*MacKinnon (1996) one-sided p-values.



Augmented Dickey-Fuller Test Equation

Dependent Variable: D(TAR)

Method: Least Squares

Date: 11/01/21 Time: 12:18

Sample (adjusted): 2001 2020

Included observations: 20 after adjustments

Variable	Coefficient	Std. Error	t-Statistic	Prob.
TAR(-1)	-0.916046	0.230300	-3.977611	0.0009
C	1350.206	337.4734	4.000925	0.0008
R-squared	0.467792	Mean dependent var		22.30500
Adjusted R-squared	0.438225	S.D. dependent var		294.5289
S.E. of regression	220.7542	Akaike info criterion		13.72662
Sum squared resid	877183.4	Schwarz criterion		13.82619
Log likelihood	-135.2662	Hannan-Quinn criter.		13.74605
F-statistic	15.82139	Durbin-Watson stat		2.011123
Prob(F-statistic)	0.000883			

EXPA STATIONARY AT FIRST DIFFERENCE

Null Hypothesis: D(EXPA) has a unit root

Exogenous: Constant

Lag Length: 0 (Automatic - based on SIC, maxlag=4)

	t-Statistic	Prob.*
Augmented Dickey-Fuller test statistic	-6.406148	0.0000
Test critical values:		
1% level	-3.831511	
5% level	-3.029970	
10% level	-2.655194	

*MacKinnon (1996) one-sided p-values.

Warning: Probabilities and critical values calculated for 20 observations and may not be accurate for a sample size of 19

Augmented Dickey-Fuller Test Equation

Dependent Variable: D(EXPA,2)

Method: Least Squares

Date: 11/01/21 Time: 12:19

Sample (adjusted): 2002 2020

Included observations: 19 after adjustments

Variable	Coefficient	Std. Error	t-Statistic	Prob.
D(EXPA(-1))	-1.426215	0.222632	-6.406148	0.0000
C	4.333419	3.690221	1.174298	0.2566
R-squared	0.707092	Mean dependent var		-0.468421

Adjusted R-squared	0.689862	S.D. dependent var	28.28151
S.E. of regression	15.74998	Akaike info criterion	8.450856
Sum squared resid	4217.050	Schwarz criterion	8.550270
Log likelihood	-78.28313	Hannan-Quinn criter.	8.467680
F-statistic	41.03874	Durbin-Watson stat	2.000289
Prob(F-statistic)	0.000007		

LONGRUN FORM AND BOUNDS TEST

ARDL Long Run Form and Bounds Test
 Dependent Variable: D(GDP)
 Selected Model: ARDL(1, 0, 0, 1)
 Case 2: Restricted Constant and No Trend
 Date: 11/01/21 Time: 12:20
 Sample: 2000 2020
 Included observations: 20

Conditional Error Correction Regression

Variable	Coefficient	Std. Error	t-Statistic	Prob.
C	139.8212	63.38924	2.205756	0.0446
GDP(-1)*	-0.338912	0.159408	-2.126074	0.0518
TAR**	-0.112856	0.047348	-2.383534	0.0319
AD**	0.013274	0.007885	1.683439	0.1144
EXPA(-1)	-0.837651	0.823408	-1.017297	0.3263
D(EXPA)	0.648564	0.670594	0.967135	0.3499

* p-value incompatible with t-Bounds distribution.
 ** Variable interpreted as $Z = Z(-1) + D(Z)$.

Levels Equation

Case 2: Restricted Constant and No Trend

Variable	Coefficient	Std. Error	t-Statistic	Prob.
TAR	-0.332995	0.136562	-2.438425	0.0287
AD	0.039167	0.011696	3.348816	0.0048
EXPA	-2.471686	2.439312	-1.013230	0.3281
C	412.5686	253.3949	1.628125	0.1258

$$EC = GDP - (-0.3330 \cdot TAR + 0.0392 \cdot AD - 2.4716 \cdot EXPA + 412.5686)$$

F-Bounds Test Null Hypothesis: No levelsrelationship



Test Statistic	Value	Signif.	I(0)	I(1)
Asymptotic: n=1000				
F-statistic	2.428006	10%	2.37	3.2
k	3	5%	2.79	3.67
		2.5%	3.16	4.08
		1%	3.66	4.66
Finite Sample: n=30				
Actual Sample Size	20			
		10%	2.676	3.586
		5%	3.272	4.306
		1%	4.614	5.966

DIFFERENCED OLS RESULTS

Dependent Variable: D(GDP)
 Method: Least Squares
 Date: 11/01/21 Time: 12:26
 Sample (adjusted): 2001 2020
 Included observations: 20 after adjustments

Variable	Coefficient	Std. Error	t-Statistic	Prob.
D(TAR)	0.067472	0.034374	1.962883	0.0373
D(RO)	0.201703	0.018172	1.194271	0.0298
D(EXPA)	1.179668	0.541816	2.177262	0.0448
C	18.062439	14.24794	0.130716	0.8976
R-squared	0.847236	Mean dependent var		17.66000
Adjusted R-squared	0.724842	S.D. dependent var		43.73624
S.E. of regression	38.50671	Akaike info criterion		10.31640
Sum squared resid	23724.27	Schwarz criterion		10.61666
Log likelihood	-99.16399	Hannan-Quinn criter.		10.35527
F-statistic	2.837048	Durbin-Watson stat		1.103624
Prob(F-statistic)	0.071106			

AUTOCORRELATION

Breusch-Godfrey Serial Correlation LM Test:

F-statistic	2.343144	Prob. F(2,14)	0.1326
Obs*R-squared	5.016761	Prob. Chi-Square(2)	0.0814

Test Equation:

Dependent Variable: RESID

Method: Least Squares

Date: 11/01/21 Time: 12:38

Sample: 2001 2020

Included observations: 20

Presample missing value lagged residuals set to zero.

Variable	Coefficient	Std. Error	t-Statistic	Prob.
D(TAR)	0.011454	0.032418	0.363319	0.7291
D(RO)	-0.002261	0.017076	-0.132391	0.8966
D(EXPA)	0.032654	0.501687	0.064902	0.9492
C	0.508774	13.31684	0.038208	0.9701
RESID(-1)	0.579067	0.267658	2.163459	0.0483
RESID(-2)	-0.252047	0.270336	-0.932349	0.3670
R-squared	0.250788	Mean dependent var		4.09E-16
Adjusted R-squared	-0.016788	S.D. dependent var		36.33618
S.E. of regression	36.63157	Akaike info criterion		10.22767
Sum squared resid	17774.52	Schwarz criterion		10.52639
Log likelihood	-96.27666	Hannan-Quinn criter.		10.28598
F-statistic	0.937258	Durbin-Watson stat		1.887640
Prob(F-statistic)	0.486788			

Heteroskedasticity Test: Breusch-Pagan-Godfrey

F-statistic	0.278179	Prob. F(3,16)	0.8403
Obs*R-squared	0.991459	Prob. Chi-Square(3)	0.8033
Scaled explained SS	0.676736	Prob. Chi-Square(3)	0.8787

Test Equation:

Dependent Variable: RESID^2

Method: Least Squares

Date: 11/01/21 Time: 12:38

Sample: 2001 2020

Included observations: 20

Variable	Coefficient	Std. Error	t-Statistic	Prob.
C	1483.238	698.6986	2.122859	0.0497
D(TAR)	1.511339	1.685658	0.896587	0.3832
D(RO)	-0.498716	0.891146	-0.559633	0.5835
D(EXPA)	-3.154379	26.56982	-0.118720	0.9070
R-squared	0.049573	Mean dependent var		1186.214



Adjusted R-squared	-0.128632	S.D. dependent var	1777.462
S.E. of regression	1888.314	Akaike info criterion	18.10161
Sumsquared resid	57051668	Schwarz criterion	18.30076
Log likelihood	-177.0161	Hannan-Quinn criter.	18.14049
F-statistic	0.278179	Durbin-Watson stat	1.288314
Prob(F-statistic)	0.840316		

MULTICOLLINEARITY

Variance Inflation Factors

Date: 11/01/21 Time: 12:39

Sample: 2000 2020

Included observations: 20

Variable	Coefficient Variance	Uncentered VIF	Centered VIF
D(TAR)	0.001182	1.321338	1.313409
D(AO)	0.000330	3.176413	1.319337
D(EXPA)	0.293663	1.046621	1.016766
C	203.0038	2.738176	NA



An Impact Assessment of E-Commerce in Textile Garment and Embroidery: A Case of Samarul HaginDogo, Zaria Nigeria

Abdullahi I. Musa&Habib Mustapha
Department of Fine and Applied Arts
Federal College of Education, Yola
Email: habibm@fceyola.edu.ng

ABSTRACT

The impact of E-commerce on garment making and embroidery designs cannot be over emphasized. Some decades ago, garment makers and embroiderers suffered in trying to create and produce appropriate designs to the need of the society. Also, it was discovered that, no flexibility in their method of production and decoration of garments, because of cumbersome nature of production and decoration. The E-commerce comes with full impact on garment making and embroidery. The result of the findings indicates that, (i) benefits of E-commerce to garment makers and embroiderers include: easy sample sharing, improvement of creativity, easy transporting of finished products and it brought online shopping. (ii) the respond of the customers to the new trend was positive (iii) different challenges were faced by garment makers and embroiderers. These include: poor power supply, buying/subscription of data, need of expensive smart phones, lack of experience to utilize the smart phone and lack of capital to buy the smart phone.

Keyword: E-commerce, garment makers, embroiderers, impact assessment.

INTRODUCTION

E-commerce has the potential to make vast amount of information available to individuals located in every part of the world. Such vast amount of information helps to facilitate rapid communication among the people. Therefore, one application of these technologies is the development of e-commerce to support electronic trading. E-commerce is any form of economic activity conducted over computer mediated networks. Its potentials attract public attention as a result of ventures, such as, the electronic bookshops and library, e-stores and number of internet based retailers. Textile garment was in existence since time immemorial, when the early man used animal skin for clothing. As time went on, traditional and manual looms were created in order to produce fabrics for peoples' consumption. The garment and textile industries in Kenya, dates from the colonial period as early as 1954. The industry had a total of seventy four (74) enterprises, employing 2477 workers (Kingangui, 2002). Since the population was increasing, the need to produce more fabrics brought about industrial revolution. The traditional and manual production of garments was gradually replaced with mechanized method which was faster and easier. Mbahi (1997) reports that, the development and distribution of crafts industries in Nigeria appeared to be dictated more by the availability and location of the people. As a result of that, the study cited example with the Quartey and Abor (2011) who said, the garment industry had about 138 medium and large-scale garment manufacturing companies in Ghana.

Nowadays, small-scale garment industries are widely spread within the country which includes appliqué designer, boutique store, clothing rental, bridal store, carpet and rugs making, garment making, crochet knitting, lace making, embroidery unit, fabric store and so on. Therefore, textile garment is a key manufacturing export for many developing countries. That means garment industry

plays a major role in the development and industrialization process of countries and their integration into the world economy. Gereffi (2002) opined that, Industrial upgrading in the garment industry is primarily associated with a shift from assembly to full package production, which changes the relationship between buyer and supplier in a direction that gives far more autonomy and learning potential for industrial upgrading to the producers.

The e-commerce has played important role in the development and modernization of small-scale garment making and embroidery. Most of the garment making shops combines garment sewing and embroidery together in one shop in Nigeria. Therefore, the new trend that is developing rapidly forces garment makers and embroiderers use e-commerce. For example, the device e-commerce applications are being implemented in the textile and apparel supply chain. Abdullahi et-al (2012) observed that, "industrialization is a stimulant to rise of other sectors of economy such as banks, insurance market and financial houses. Many embroiderers benefit from e-commerce through acquiring different patterns which are exclusively tied to art of beauty. These patterns are intricately created to adorn the garments in order to add marketability values through the use of e-commerce. Though, the major problem confronting the embroiderers and the garment makers is the issue of marketing problem in their business. Few of these people find it difficult to in co-operate any of the e-commerce application in their production and transaction of business. This study, intends to find the impact of e-commerce in textile garment and embroidery making.

Statement of the problem

Some decades ago, garment makers and embroiderers started to accept the use of e-commerce to improve their trades for development purpose. Many people claimed that industries in developing countries increase and improve their performance in international trades through the use of e-commerce devices. It is expected that, e-commerce will increase the availability of relevant information which will contribute to industrial and national development. Grace (2001) explained, development as the process whereby community undergoes social and economic transformation geared towards an improvement in quality of its citizen.

Nowadays, different applications such as Facebook, WhatsApp Instagram and so on are commonly used among the artists and artisans. Therefore, the problem of this study is to assess the impact made by e-commerce on garment making and embroidery designs.

Research question

The following research questions were used for this study;

- i. How do the garment makers and embroiderers benefit from the e-commerce
- ii. To which extent are the responses of customers to this new trend?
- iii. What are the challenges in using e-commerce in garments making and embroidery designs?

METHODOLOGY

The study adopted a survey research design that uses hybrid approach which requires both qualitative and quantitative data through observation. Verbal interview was conducted to both garment makers



and embroiderers who are operating in Samaru and Hagin- Dogo, Zaria. The population of this study included all garment makers and embroiderers. Therefore, there are one hundred and fifty (150) shops in both areas. Averagely, each shop has three garment makers and embroiderers, making a total of four hundred and fifty (450). Out of this population, 10 percent% was taken to serve as sample for the study, because Nwana (1981) in Abdullahi(2011) said, 10 percent % is adequate for a survey research.Thus, 45 respondents were chosen randomly from the total population of garment makers and embroiderers to serve as the sampled population. Mbahi (2001) says, "Sampling is a group of items taken from the population for examination.Moreso, it is the limited number of items taken from population which is representation of that population. The data was analyzed using ordinal scale. According to Emaikwa(2011) "ordinal scale tells us that the highest score occupies the first position, and next highest score occupies second position. For example, when data was obtained, the researcher needs to arrange them according to their ranks. That is, the bigger number first and the smallest number to occupy the last position. Also, there is the need to show the difference between the scores obtained from the field work. Thus,thenumbers should be arranged to show difference like this:

S/N	Data collected	Difference	Position
1.	30	-	1 st
2.	27	3	2 nd
3.	24	3	3 rd
4.	18	6	4 th
5.	10	8	5 th

Data Analysis

The data collected was analyzed using ordinal scale to show the hierarchy among the opinions of garment makers and embroiderers on the impact of e-commerce to garment making and embroidery. Therefore, it will be noted that all the garment makers and embroiderers were male and their average ages ranges between 35-45 years. Also majority of them acquired secondary education, followed by diploma and few acquired degree certificates.

BENEFITS	SCORE	RANK
Samples are shared easily	16	1 st
Its improves creativity	13	2 nd
E-banking is easier	9	3 rd
Finished works are transported easily	4	4 th
It brought online shopping	2	5 th

Table 2: Benefits of e-commerce to Garment Makers and embroiderers

The table above indicates that, majority of the respondents which were 16 in number agreed to benefit from e-commerce through samples sharing using facebook, instagram,whatsapp or twitter. While 13 of the respondents responded that, e-commerce improves their creativity through obtaining new styles from different applications on the internet. So, the third in the ranking were 9 respondents who said, they benefitted through easy transferring of money for business. (e-banking).Another benefit of e-

commerce which was ranked the fourth was the easy transporting of finished products after purchase and this transaction is normally done through telecommunication and transferring money to the owner of the product. In his own part transport the goods to the buyer who sent the money for the goods.

RESPONSE	SCORES	RANK
Positive	39	1 st
Negative	6	2 nd

Table 3: Responds Of the Customers to the New Trend

The table indicates that, majority of the respondents which totaled 39 accepted the new trend, because it brings modernization in garment making and embroidery design pattern and apart from improving income generation this gives individual consumer room for selecting the best style for his own interest. But those who responded negatively were 6 in number, because they stick to tradition, because they may likely not be able to browse from the internet.

CHALLENGES	SCORES	RANK
Poor power supply	14	1 st
Constant buying data	13	2 nd
Need for expensive hand set	10	3 rd
Lack of experience	6	4 th
Lack of capital	2	5 th

Table 4: The Challenges Garment Makers and Embroiderers face.

The table indicates that, poor power supply which was agreed by 14 respondents is the major problem faced by garment makers and embroiderers, because most of their machines use power to utilize them. Also, power is needed to recharge their cell phones. But 13 of the respondents reported that, subscription of data for browsing makes them tiresome and their savings is always tampered. Also, the need for expensive cell phone is another problem which was pointed out by 10 respondents. This is also couple with the fact that not all cell phones users have the experience to use and browse with smart phone as reported by 6 respondents. They have to do weekly contribution for a long time before one affords the money to buy machine.

DISCUSSION AND IMPLICATION OF THE FINDINGS

Research Question 1: how do the garment makers and embroiderers benefit from e-commerce?

The findings indicate that, sample was shared easily among the garment makers and embroiderer was ranked first position, because there was that cordial relationship among the tailors that made them to be posting latest designs to one another. That is why Aminu(2014) made observation that, one of the



goals of vocational and technical education is to increase the employability of school leavers. This really increases participation of individuals to the businesses. Also, the second in the ranking was "it improves creativity that is, people copy different samples posted to them and produce exactly the same samples shown to them. Likewise, e-banking assists greatly in the transaction of business, because money can be transferred instantly and easily for product or work done for the customers. All these developments are achieved in order to participate in the development of our societies. Though in Nigeria, people go to school with the belief that education will enable them participate in the society. But from the look of things, full participation in Nigerian society requires vocational and technical education at all levels of educational system.

The implication of this is that, constant use of applications in designs reduces originality of the design. The designer will not be able to create original design by himself, unless he sees samples.

Research Question 2: What are they respond of the customers to the new trend

Finding indicates that almost all the respondents pointed out that the customers like the new trend. Therefore, different styles are always demanded by the customers, before producing their garments.

The implication is that, our social culture, especially garments generally are changed and the western style greatly influenced and affected our native dresses.

Research Question 3: The challenges Garments makers and Embroiderers Face

The finding indicates that, poor power supply, buying data, expensive handsets, lack of experience and lack of capital are the challenges of using e-commerce in production of design generally. These challenges become a threat to the garment maker and embroiderers.

SUMMARY OF THE FINDING

This study on; An Impact Assessment of E-Commerce in Textile Garment and Embroidery Making in samaruHaginDogu, Nigeria, has been given various responses from the respondents concern. Therefore, the following are the summary of the findings;

- I. The study revealed that, the research question one explains how garments makers and embroiderers benefit from e-commerce through sharing of design samples and gives room for creativity and innovation. Also the result of introducing e-commerce into textile garment and embroidery simplifies business transaction and gave rise to e-banking through buying and selling textile finished products.
- II. On the issue of whether the customers accept the new trend or not, this study reveals that almost all the respondents responded positively. Most people demand design samples from the garment makers and embroiderers when they bring their fabrics for sewing.
- III. The study reveals that, the challenges faced by garment makers and embroiderers includes; poor power supply, lack of money to subscribe for data, the need for expensive smart phones and so on are creating problems to the garments and embroiderer

Different Styles of Garment and Embroidery Designs



Plate 1: Machine Embroidery Design. Husein 2018



Plate 2: Handmade Embroidery Design. Husein 2018

CONCLUSION

Due to globalization e-commerce penetrates through all aspect of our lives. Our traditional system of producing garments and embroideries completely have changed as a result of e-commerce. Garment makers and embroiderers use different applications to get new information in order to improve their productions. The effective utilization of e-commerce brought about modernization into our society, nowadays. Despite the challenges faced by the garment makers and embroiderers in the areas of possessing relevant cell phones, poor power supply, experience to use and browse with the handsets or computer and so on, yet the impact of e-commerce can be seen in our garments and embroideries.

RECOMMENDATION



The following recommendations are hereby forwarded in order to improve the production of garments and embroidery designs;

- i. Research effort should be made towards finding out the advantages and disadvantages of using e-commerce in garment and embroidery designs.
- ii. Since the garment makers are used to or conversant with different applications to create designs. Therefore, they should promote their product through E-catalogues.
- iii. Garment makers in particular should reduce the production of dresses that pronounce the contour of human body in the name of modernization. This will always be an abuse to other people's culture and religion.

REFERENCES

- Abdullahi, I.M., Mustapha, H.D. (2012) .The role of large scale textile industry in Improving National development, African Journal of Educational Research And Administration, Nsukka; Devon Science Publication.
- Abdullahi I.M. (2011) an investigation into the problems of large-scale textile Industries in Kano State. M.A. thesis, Department of Industrial Design; Zaria; Ahmadu Bello University.
- Adamu, B and Omar, B.A. (2007) Integration of Information and Communication Technology. International Journal of Research in Education. Vol.3, No.6. pp58. Accra-Ghana; Pan-African Book Company.
- Aminu, A.A. (2014) Entrepreneurship, Theory and Practice: First Edition, Kaduna; Pylamark Service Limited.
- Dadzie, P.S. (2006) Electronic Resources: Access and Usage at Ashesi University College Campus-Wide Information Systems 22(6) Retrieved from <http://www.emeraldinsight.com>
- Gereffi, G. (2002) Outsourcing and Changes in the apparel Commodity Chain. Paper presented at the conference on responding to globalization, societies, Groups and Individual. Hotel Boulderacho. 2002. <http://www.colorado.edu/IBS/PEC/gadcoms/papers/Gereffi.pdf>.
- Grace, .I.O. (2001) The Education of women in developing Country, Markudi, Osuman and co.
- Mbahi, A.A. (2001) Research Methodology: A Practical Guide to Research in Fine Art, Applied Art and Performing Art. Maiduguri; Research in computer Graphics and print.
- Neil, G.C. (2005) Students reflection on effectiveness of ICT as learning Achievement. Retrieved 8, 2007 from <http://www.aarc.edu.au/05ap/nea05582.pdf>
- Quartey, P. and Abor. J. (2011) Do Ghanaians Prefers Imported Textile to Locally Manufactured ones? Modern Economy 2, 54-61. <http://dx.org/10.4236/me.2011.21009>.



DESIGN AND IMPLEMENTATION OF AN IoT BASED MONITORING AND PROTECTION SYSTEM FOR DISTRIBUTION TRANSFORMERS

¹Ogbekhiulu A., J. & ²Agbontaen F. O

¹Department of Electrical and Electronic Engineering,
College of Engineering and Technology, Federal University of Petroleum Resources, Effurun.

²Department of Electrical / Electronic Engineering,
Faculty of Engineering, University of Benin, Benin City, Edo State.
Email: ogbekhiulu.joseph@fupre.edu.ng

ABSTRACT

Transformers are the main components in a power system. Any fault in the transformer adversely affects the balance of a power system. The faults are mainly occurring due to overloading and inefficient cooling system in the transformer. This paper present a real time monitoring system of the health condition of distribution transformer using IOT (Internet of Things) Technology. Parameters such as temperature, oil level, humidity, voltage, current and location of a transformer are monitored, processed and recorded in servers. The system also have an anti-theft security (alarm) system as well as surveillance camera and backup security lighting unit for late hours for the protection of the substation against vandals and unauthorized personnel having access to it. The database used in this paper is the firebase database and it can be accessed from anywhere around the world using IoT technology through HTTP protocol. Messages are sent to pre-stored mobile numbers when any abnormalities in the parameters being monitored is observed using existing network. This helps in identifying and solving a problem before a failure could occur in the system without human dependency. The transformer parameters are monitored on a mobile application with the access being controlled remotely via the mobile application designed for the system. The transformer automatically isolated the load/consumer loads from the power supply when load current, oil temperature increases beyond the preset values. An alarm gets activated and the ESP32 camera captures the intruder when unauthorized personnel try to access the power substation. The system was then implemented and tested. The results obtained indicates that the parameters of the transformer and the substation can be conveniently monitored using IoT technology.

Keywords: IoT, Distribution Transformers, Mobile Application, Firebase Database, ESP 32

INTRODUCTION

In power system, a transformer is an electrical equipment which supplies power from the generating station to consumers directly. Distribution transformer has a long service life if they are operated under rated conditions. Their service life is significantly reduced if they are subjected to overloading and under voltage conditions for a long time, also low oil level and high winding temperature leads to insulation failure resulting in breakdown. Overloading and ineffective cooling of transformers is the major cause of failure in distribution transformer. Distribution transformers are currently monitored manually which cannot provide information about occasional overloads and overheating conditions of transformer oil and windings. Most power companies use Supervisory Control and Data Acquisition (SCADA) system for online monitoring of power transformer; extending the SCADA System for online monitoring of distribution transformer at the remote area is an expensive proposition due to long distance. In most rural and urban areas, these transformers are being exposed to the access of unauthorized persons causing inherent parts of the transformer such as transformer cables and oil to be stolen by thieves and vandals.

For these reasons, there is the need for a distribution transformer real-time monitoring system to detect all operating parameters such as oil and winding temperature, oil humidity, oil level, load



current, and voltage output continuously and sent to the monitoring center in time. In order to eradicate retrogressive theft actions completely, there is need for a system to detect human presence, state the location of the particular transformers in question among others and surveillance camera for observing the substation vicinity. A backup power system to supply camera and other protective device for surveillance in case of power outage is necessary.

A sensor or a network of sensors is required to sense the physical parameters of their respective environment. These processed sensor outputs are then sent to the main server or cloud with the help of various network devices. The data can be accessed over internet from anywhere around the world. Monitoring and controlling form the basic objective of IoT technology. Hence, IoT based monitoring is preferred to manual or SCADA monitoring. This will help to identify the faults before a serious failure occurs and isolate the consumer load from the transformer automatically.

REVIEW OF RELATED WORKS

A lot of work have been done by various researchers on the monitoring and protection of distribution transformers; various researches have been done in this direction and the very relevant ones are discussed below:

Arun et al, (2020) proposed a system that prevents Faults in single phase distribution transformers. Temperature sensor, ultrasonic sensor, voltage sensor, current sensor was used in his work, to measure the readings.

Biju et al, (2019) designed a system that does the real time monitoring of the health conditions of the distribution transformer using IoT technology to monitor parameters such as temperature, voltage and current of a transformer and, processed and recorded in servers.

Maithili et al, (2019) proposed a system that monitor and control distribution transformers efficiently which consists of a wireless controlling system to open or close the transformer circuit/switches.

Mali et al, (2019) proposed a system that provides effective monitoring and protection of distribution transformer by measuring its oil level, oil colour quality and temperature. Jenifer et al, (2018) designed a monitoring and protection system for distribution transformer with the help of GSM and GPS technology. A system which continuously monitors the transformer parameters such as load current, voltage, oil level and ambient temperature with the help of sensors.

The system was designed taking into consideration the limitation and lapses of various works and documentations done by various authors as it encompasses all of the parameters (current, voltage, oil level, oil temperature and humidity measurement. Theft Protection, automatic isolation, SMS alert, surveillance camera, Firebase Database for data access over the internet from anywhere around the world, remote

operation and access of transformer unit using a designed mobile application) gives this work an edge over the others done from previous years till date.

METHODOLOGY

The main goal of the system is to reduce drastically the sudden breakdown of any distribution transformer and to identify and track the transformer fault in any location using the GPS module and communicating the problems to the Engineer or Technician using the GSM module and IoT technology (Firebase database) when an abnormality occurs. Transformer sudden break-down occur due to unnoticed sudden change in transformer parameters. The scope employed in the design and implementation of this work took into consideration the hardware design (designing, testing and modeling) and software design. The main components used for designing the system are sensors, ESP32 microcontroller, GSM, GPS, ESP32 Camera module and Firebase database, and transformer security mobile application.

Battery Charge Controller was used to provide over charge protection, over discharge protection, short circuit protection, and soft start protection to limit inrush current, trickle charge (battery reconditioning) for the lithium-ion battery backup power source. An AC-DC converter module was included to convert the 230VAC input voltage from mains power supply to 5VDC output, which is fed to the battery charge controller. A boost converter (also known as a step-up converter) is a DC-to-DC power converter that increases voltage while decreasing current from its input supply; a high efficiency switching regulator (XL6009 IC) produced a fixed output voltage of 5V, and 12V. The microcontroller used in this paper is ESP32 microcontroller. This microcontroller is a series of low-cost, low-power system on a chip microcontrollers with integrated Wi-Fi and dual-mode Bluetooth.

For the purpose of this work, six (6) 3.7V, 2000mAh Li-ion batteries were used on both the domestic and industrial transformer section in the construction of the charging units making it a total of twelve (12) Li-ion batteries used. Li-ion batteries provide a variety of advantages over other high-quality rechargeable battery technologies (nickel-cadmium or nickel-metal-hydride). They can supply a lot of current for high-power applications. Li-ion batteries also have low-maintenance, as they don't need to be cycled on a regular basis to keep their life. Li-ion batteries have no memory effect, which is a harmful phenomenon in which a battery might remember a decreased capacity after repeated partial discharge/charge cycles. They are rechargeable, although most lithium batteries are not. Li-ion batteries are more stable and can be recharged hundreds of times. Compared to other rechargeable batteries, they feature a better energy density, voltage capacity, and lower self-discharge rate hence the choice for this work.

A few functions of the sensors and components to be used are stated below; DHT22 temperature and humidity sensor- to measure the temperature and humidity of windings and oil, ACS 712 current sensor- to measure the output current from the transformer, ZMPT101B Voltage sensor module - used to measure voltage of the transformer, HC-SR04 Ultrasonic sensor - used to measure the oil level, for IR proximity pair to detect the theft of transformer, ESP32 Surveillance camera module for image capturing in the case of theft and rechargeable lithium ion battery units for backup power supply.



These units work in harmony to help monitor and protect the distribution transformer. The ultimate goal is that the ideas and planning demonstrated through this model system can then be easily upgraded and implemented on a larger scale for distribution transformer.

Since, this design is a prototype and as such, the scope is limited to certain number of parameters to be monitored as reactance, inductance, power losses, frequency, power factor hysteresis losses are unaccounted for. However, the design can be upgraded to a large scale to accommodate for other parameters to be monitored.

DESIGN ANALYSIS

In this system, power supply from battery is used to provide the required voltage and current to the whole sensors. EPSS2, GSM, GPS are the main component used for designing the system. EPSS2 is automatically interfaced and the output is displayed on the TFT LCD. Messages are sent through GSM to user to understand measured parameter and location of transformer by GPS. In Software Implementation, the main part is programming of EPSS2 and interfacing of each device like sensors and relays. Once the power is supplied, the given hardware circuit gets initialized. The EPSS2 interfacing with TFT LCD displays measured parameter like voltage, current, oil temperature, oil level, and humidity and transformer access status before and after any problem occurs in the transformer. After data is displayed on the LCD, it is sent to the user through the GSM module so the user can identify which of the transformer problem has occurred.

These measured parameters are uploaded to a firebase database to provide real time information. Captured images are stored in a created google drive account for analysis. Also, a mobile application is designed to grant access to authorized personnel and monitor transformer parameters. The surveillance system include camera for capturing images, Light Dependent Resistor (LDR) for automatic lighting in a dark environment and an alarm system for notification when intruder or unauthorized personnel enters the transformer house.

Software Design Analysis: The transformer security mobile application was designed on MIT APP Inventor, a designed online platform. Individuals create applications by dragging and dropping components into a design view and using a visual blocks language to program application behavior. It provides a web-based —What you see is what you get (WYSIWYG) editor for building mobile phone applications targeting the Android and iOS operating systems. App Inventor also supports the use of cloud data via an experimental Firebase, Firebase Real-time Database component. The Firebase Real-time Database is a cloud-hosted database. Data is stored as JSON and synchronized in real-time to every connected client. When one builds cross-platform apps with iOS, Android, and JavaScript SDKs, all clients share one real-time Database instance and automatically receive updates with the newest data.

Design and Implementation of an IoT Based Monitoring and Protection System for Distribution Transformers

The captured images are stored on google drive created using google app script. Figure 1. Shows the block diagram of the system.

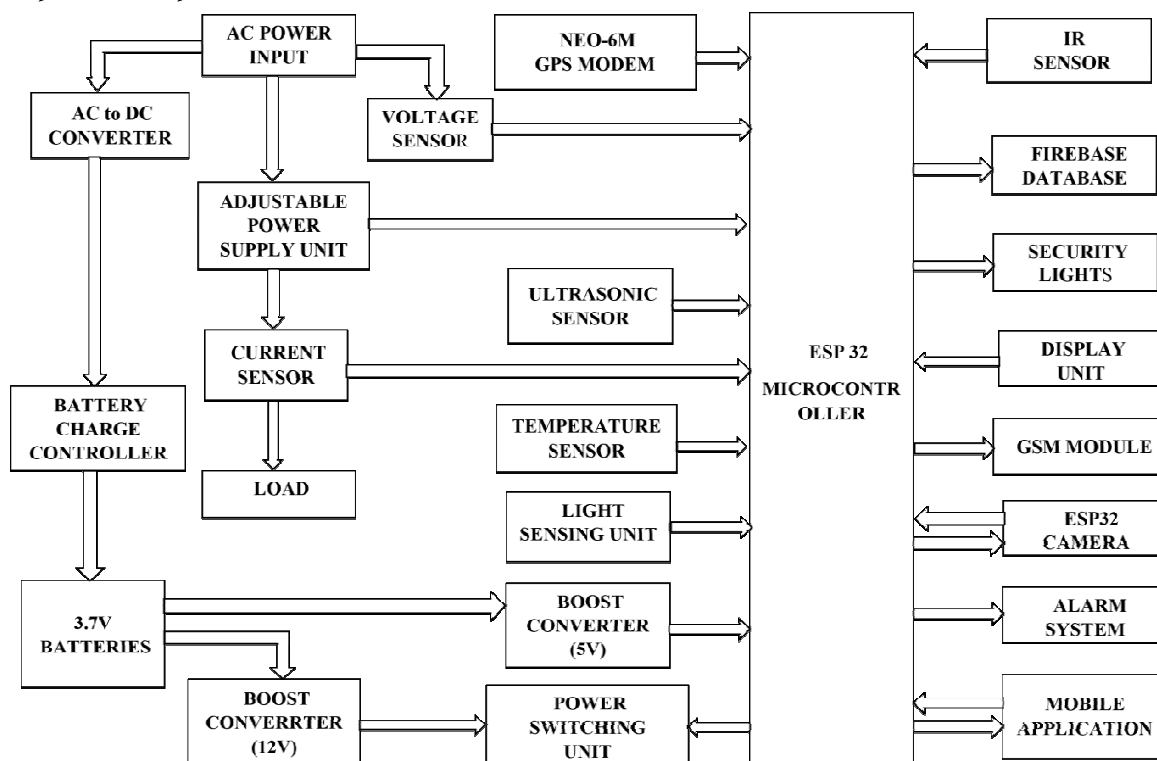

Fig.1: System Block Diagram

The system was designed from the known parameters given below:

Boost Converter

Input Voltage = 3.7V (from battery unit)

Output voltage $V_{out}=?$

Recall; $V_{out} = 1.25 \left(1 + \frac{R_2}{R_1} \right)$

Specified resistor values from the manufacturer:

$R_1 = 15K\Omega$, where $R_2 = 3 \times R_1 = 45K\Omega$.

$V_{out} = 1.25 \left(1 + \frac{4500}{1500} \right)$

$V_{out} = 1.25 (1 + 3)$



$$V_{out} = 1.25 \text{ (4)}$$

$$V_{out} = 5V$$

TP4056 circuit;

Resistor – R_{prog} .

$V_{PROG} = 1V$ (a constant reference voltage)

$$I_{prog} = \frac{V_{PROG}}{R_{PROG}} \dots\dots\dots (1)$$

$$I_{charge} = I_{prog} \times 1200 \dots\dots\dots (2)$$

Also;

Given battery charge current $I_{charge} = 1A$

Substituting equation (1) into (2)

$$I_{charge} = \left(\frac{V_{PROG}}{R_{PROG}} \right) \times 1200$$

$$R_{PROG} = \left(\frac{V_{PROG}}{I_{PROG}} \right) \times 1200$$

$$R_{PROG} = \left(\frac{1}{1} \right) \times 1200$$

$$R_{PROG} = 1200\Omega = 1.2K\Omega$$

Voltage Conversion:

We need to convert the output voltage range (5v to 15v) from the LM317 voltage to voltages between the range of 180–250v. For this reason, some equations/formulas were derived below:

Let: Y represents any voltage between 5–15V

X represent any voltage between 180–250V



$$\frac{X-180}{250-180} = \frac{Y-5}{15-5}$$

$$\frac{10}{70} (x - 180) = y - 5$$

$$x = [7(y-5)] + 180 \dots\dots\dots \text{Required Formula}$$

Some Results obtained after applying the required formula above for different values of y ;

Table 1: Voltage Conversion Result

S/N	y (V)	x (V)	Approximate Value (V)
1.	10	216	
2.	12	229	230
3.	8	201	200

Therefore,

$$5V - 8V \sim 180V - 200V$$

$$8V - 12V \sim 200V - 230V$$

$$12V - 15V \sim 230V - 250V$$

RESISTOR R_v , (multi-turn variable resistor):

Values of Multi-Turn Variable Resistor: How we chose the range of the multi-turn variable resistor (R_v) as used in the power supply circuit was derived below:

$$\frac{V_{out}}{1.25V} = 1 + \frac{RV1}{R1}$$

$$\left(\frac{V_{out}}{1.25V} - 1\right) = \frac{RV1}{R1}$$

$$\left(\frac{V_{out}}{1.25V} - 1\right) R1 = RV1$$

$R1 = 180V$ and given $V_{out} = 5V$ and $15V$ for the lower and upper voltages respectively, the obtained values for $RV1$ is derived as follows:

$$\text{When } V_{out} = 5V: \left(\frac{5v}{1.25V} - 1\right) = \frac{RV1}{180}$$

$$RV1 = 640\Omega$$

$$\text{When } V_{out} = 15V: \left(\frac{15v}{1.25V} - 1\right) = \frac{RV1}{180}$$

$$RV1 = 1980\Omega$$

The complete circuit diagram of the design is shown in Fig 2.

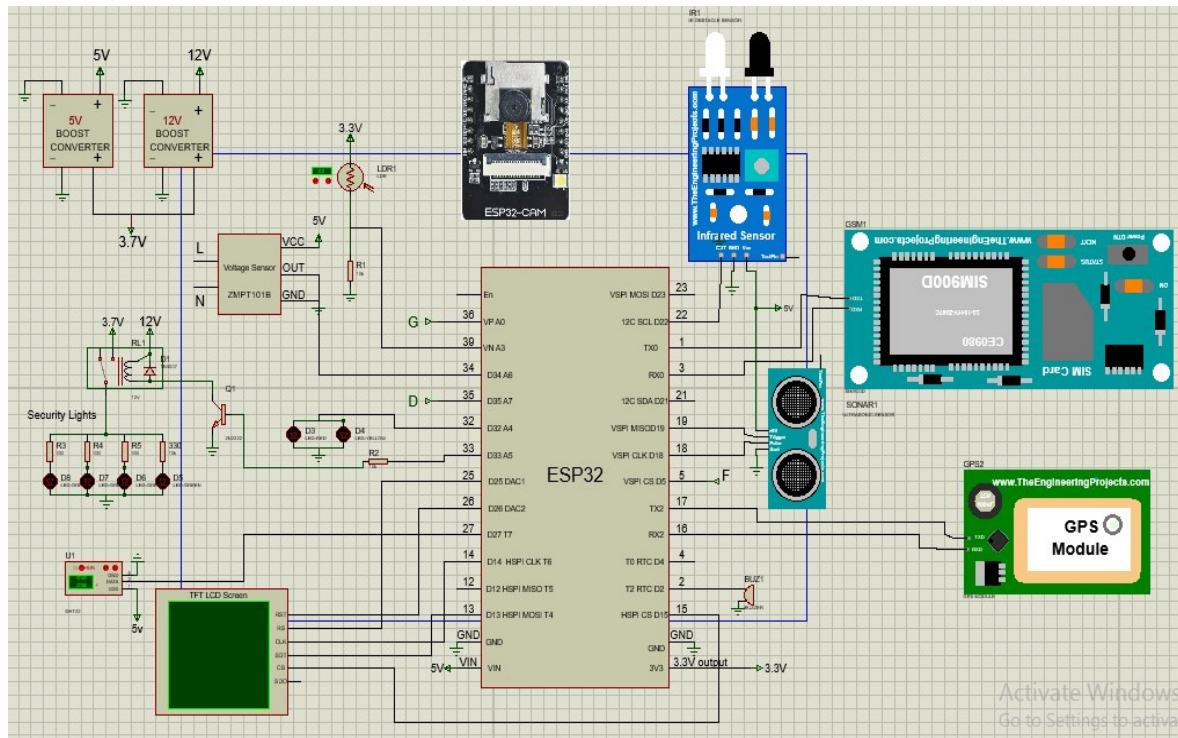

Figure 2. : System Circuit Diagram

DESIGN IMPLEMENTATION

The project was implemented in stages so as to simplify the construction process. Each unit in the hardware design stage were implemented and tested separately before assembling them together. The entire system was constructed on a Vero board because of its availability and cheap cost and then re-tested, and altered where necessary until it works as desired as shown in fig.3. The software user interface (mobile application) required for the project was designed on MIT app inventor; a free online platform. The software code necessary for the functionality of the ESP 32 microcontroller was written in C programming language and compiled on Arduino IDE software. All errors discovered during hardware design stages on Proteus software were corrected until the code worked perfectly as expected on the virtual circuit.

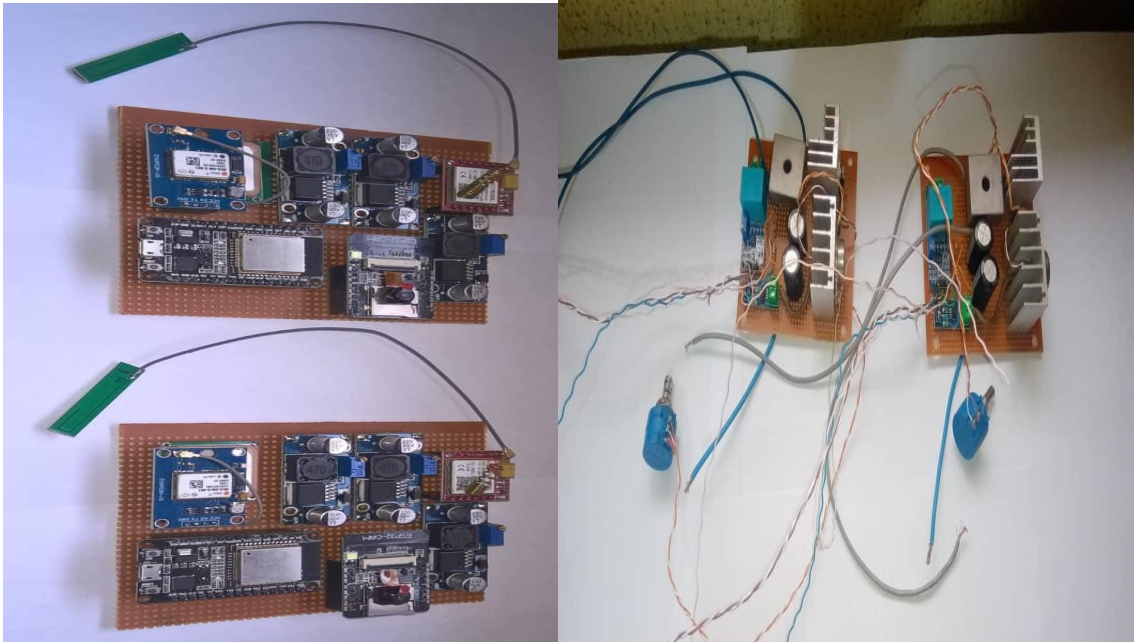

Fig. 3: Vero Board Implementation of Control, Camera and Output Unit

Fig. 4: Power Supply Unit

TESTING

Each section of the project was tested separately before it was integrated into whole system. Various tests were carried out on the system before and after coupling it; to ensure maximum operating efficiency and to prevent damage of components.

Voltage / Power Supply Test:The power supply test was carried out to ensure that the required voltage is being supplied to each unit that needed voltage to function at different point in the circuit network. The voltage level of the backup battery was measured before and after the battery is fully charged. The six batteries are connected in parallel with ratings – 3.7V, 2000mAh. A multimeter was used to test the output voltage of the battery and the result was:

Fully Charged Condition = 4.2V

Battery in Use = 19.8V

Battery completely discharged = 2.12V

Continuity Test: This test was carried out during the construction and installation of each unit that is connected to the power supply. The test was done by placing the negative probe and positive probe of the multimeter on the desired points. This test is done to check the validity of an electrical path; this test was carried out during the assembling of the project components, particularly on the soldering done on the Vero board.



Short-Circuit Test: Short-Circuit test was conducted on the power supply unit and control unit using a multi-meter. It was conducted to prevent bridging of components.

Open-Circuit Test: This test was carried out in order to know the connection lines on the power switching circuit that were not properly soldered. The result was that all the connection line was properly soldered because no broken line was found.

Operational/Performance Test: Performance test was conducted to determine the system response to input signals from sensors such as DHT 22, IR sensors, current sensor, ultrasonic sensor as shown in fig.4. and it was tested okay. This is done to ensure that the values displaying on the TFT LCD Screen correspond to the measured valued with multimeter.

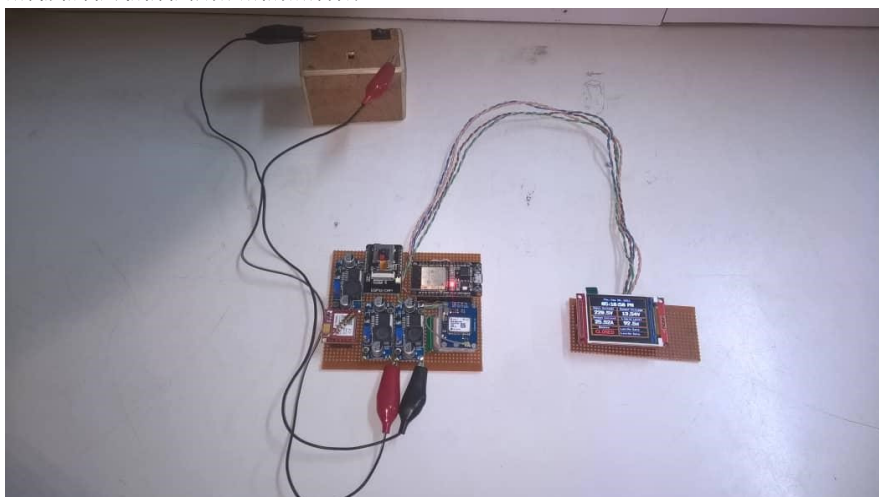

Fig. 5: Operational Test

RESULT AND OBSERVATIONS

The results obtained during performance/operational test are shown in figures 6, 7, 8, 9,10 and 11.



Fig. 6: TFT LCD Screen Result Showing Transformer Parameter

Figure 6 shows the test result of the transformer parameter obtained when the system was put on. The domestic side indicates that the input voltage was 10.22 V while the output voltage was 214.77V, output current 0.26A and the liquid level was 71% with a humidity level of 86.60% and the gate of the substation was closed. Figure 7 shows the result obtained during certain conditions of the transformer in the substation. A Google message via sms was sent to the personnel indicating that there was an under-voltage of 152.00V to the transformer located at Soande House, Boluwufe Estate while at another time, there was an over-voltage condition of 239.00V at the same substation. The result also show an alert sent to the supply authority personnel that there was an unauthorized entry to the transformer substation at the same location. These results were sent with a Google map location. When the transformer at Brussel location was overheating due to overload condition, a sms through Google was sent to the personnel showing that the overload current was 3.90A in the transformer as shown in figure 8. The results also gave direction to the personnel to locate the transformer and the substation in town. Figure 9 shows real time information of transformer parameters on firebase such as assess to the transformer in the substation open, input voltage 8.53V, liquid level 41%, output current 0.21A, output voltage 230.24V, power "ON", transformer temperature and humidity 29.50°C & 79.60 and an input voltage of 15.12V. Figure 10 shows the photographs of the captured images of the substation at night and uploaded to Google drive folder of the service personnel of the supply authority. With the lights on at the substation gives security to the transformer against unauthorized persons entry into the substation. Figure 11 shows the transformer parameters displayed on mobile application of the service personnel of the power supply authority.

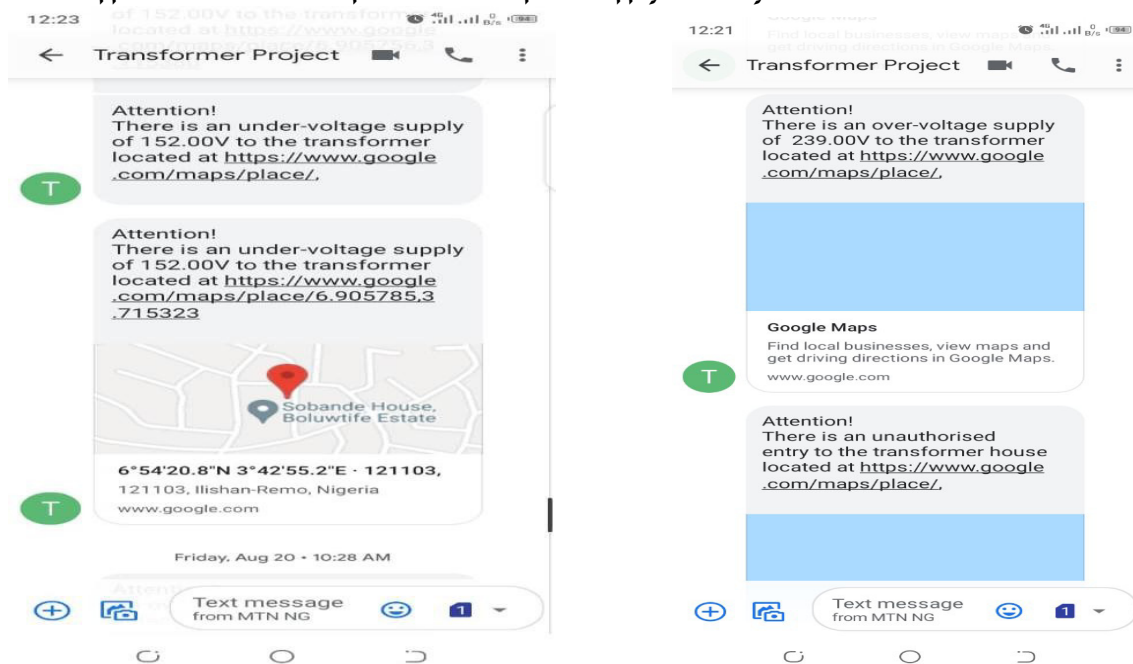

Figure 7: SMS Alert Notification for Under Voltage, Over Voltage, Unauthorized Personnel with Transformer Location.

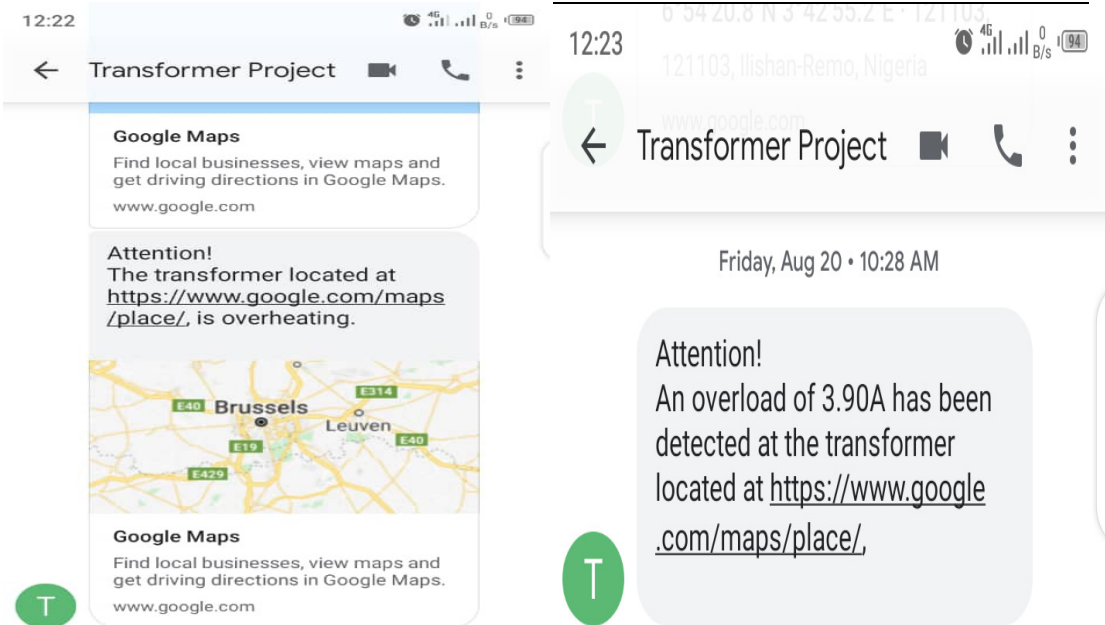

Figure 8: SMS Alert Notification for Transfer Overheating and Over Load Condition.

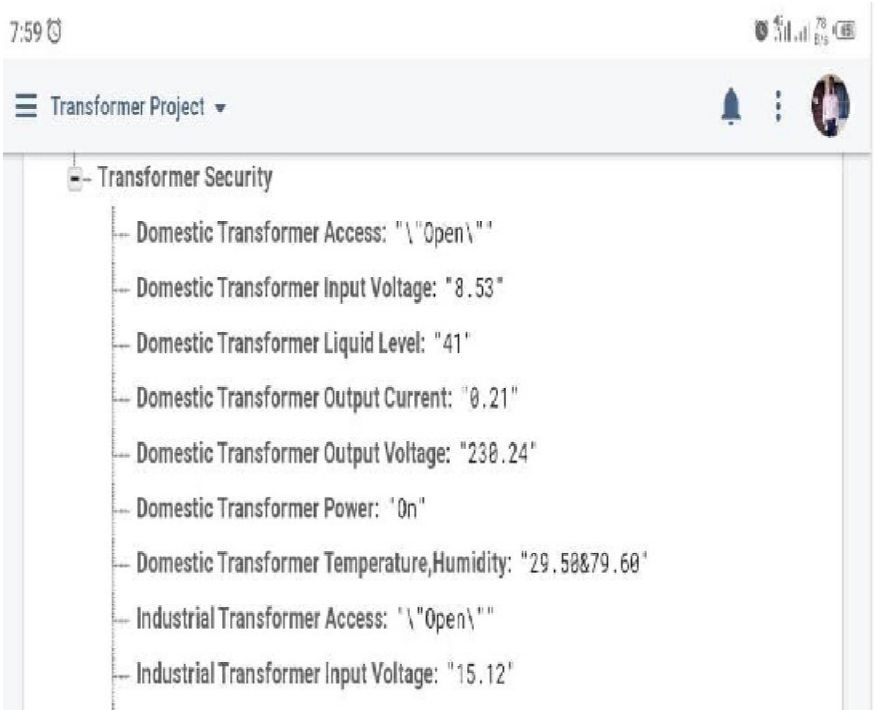

Figure 9: Real Time Information of Transformer Parameters on Firebase

Design and Implementation of an IoT Based Monitoring and Protection System for Distribution Transformers

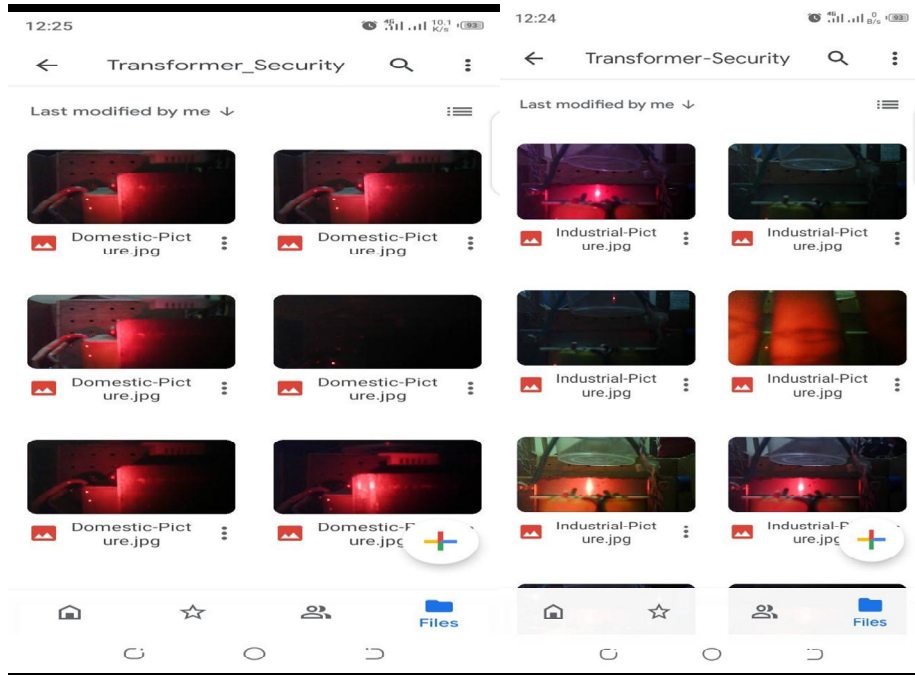

Figure 10: Captured Images Uploaded to Google Drive Folder

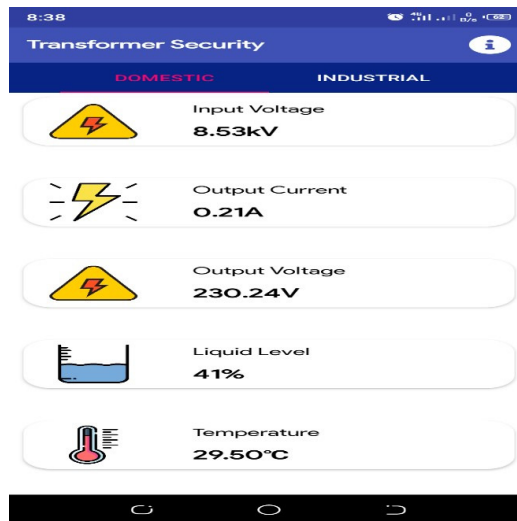

Figure 11: Transformer Parameters displayed on Mobile Application

Table 2: Temperature Analysis

S/N	CURRENT LEVEL	LOAD (ON/OFF) CONDITION
1	LESS THAN 1.34 AMPS	OFF CONDITION
2	MORE THAN 1.34 AMPS	ON CONDITION



Table 3: Current Analysis

S/N	TEMPERATURE LEVEL	LOAD (ON/OFF) CONDITION
1	$-10^{\circ}\text{C} \leq t \leq 40^{\circ}\text{C}$	ON CONDITION
2	$t > 40^{\circ}\text{C}$	OFF CONDITION

Table 4: Voltage Analysis

S/N	VOLTAGE LEVEL	LOAD (ON/OFF) CONDITION
1	180V – 200V (Under Voltage)	OFF CONDITION
2	200V – 230V (Normal Voltage)	ON CONDITION
3	230V – 260V (Over Voltage)	OFF CONDITION

The results obtained also shows that when the temperature of the transformer is between -40°C and 40°C , the load is in the “ON” condition but it goes “OFF” when it rises above 40°C as shown in table 2. Table 3 shows the current analysis of the transformer condition when it is less than 1.34Amps, the load goes “OFF” while it is “ON” when it rises above 1.34Amps. When the voltage of the transformer is between 180V and 200V, it indicate an under voltage condition and the load is “OFF” while between 200V to 230V, is the nominal voltage level and the load is “ON” . However, when the voltage rises from 230V to 260V, it indicates an over voltage condition and the load goes “OFF” as shown in table 4.

CONCLUSION

This paper introduces a new and improved method of transformer health parameter monitoring using IoT. Thus, the real time data collection, storage and monitoring of the transformer health parameters are possible with this system. Regular monitoring of the health condition of transformer is not only economical, but also adds to increased reliability. For long distance data transmission, GSM technology is a reliable and robust one. Any kind of fault occurring in the distribution system results in the GSM modules sending instant messages automatically to the base station (authorized personnel). This paper provides remedies from the fault occurring in transformers and it overcomes the drawbacks of previous working methods.

The mobile application and firebase database will be a helpful tool for transformers parameters data to help the utility in observing the operational condition of their transformers before any catastrophic failure could occur and this is cost effective and improves power system reliability and optimization.

REFERENCES

- Arun, G., Arunkumar, R., Krishna, K., Muthupattan, .P, & Kannayeram, G. (2020). GSM Based Single Phase Distribution Transformer Monitoring and Control. *Journal of Critical Reviews*, Vol. 7, No. 12, pp. 637-640.

- Aravind, P. (2017). Transformer Theft Protection and Supervising Using Advanced GSM Technology. *International Journal of Advanced Research in Electrical, Electronics and Instrumentation Engineering*, Vol. 6, No. 11, pp. 8664-8669.
<https://doi.org/10.15662/IJAREEIE.2017.06>.
- Asaduzzaman, N., Mehdi, H. S., Muhit M. S., & Khaled, H. (2014). Fault Analysis and Electrical Protection of Distribution Transformers. *Global Journal of Researches in Engineering: F Electrical and Electronics Engineering*, Vol. 14, No. 3, pp. 60-66.
- Biju, R. B., Amanraj, S., Akhil, S., & Nayana, S. (2018). IoT based Distribution Transformer Health Monitoring System using Arduino, Nodemcu and Thingspeak. *International Journal of Engineering & Technology (IJERT)*, Vol. 8, No. 4, pp. 673-676.
- Dharanya, S., Priyanka, M., Rubini, R., & Umamakeswari, A. (2013). Real Time Monitoring and Controlling of Transformers. *Journal of Artificial Intelligence*, Vol. 6, No. 1, pp. 33-42.
<https://doi.org/10.3923/jai.2013.33.42>.
- Gopiya, N. S., Subramanya, Y. A., & Raghu, M. (2020). IoT based Monitoring and Control of Faults in Power Distribution Transformers. *International Journal of Electrical and Electronics Engineering*, Vol. 7, No. 12, pp. 37-41.
<https://doi.org/10.14446/23488379/IJEEV7112P107>.
- Jenifer, A., Bharati, B.R., & Shanthi, M.B. (2018). Monitoring and Protection of Distribution Transformer Using GSM Module. *Internal Journal of Engineering and Techniques*, Vol. 4, No. 1, pp. 565-569.
- Maithili, P., Mathankumar, A., Dinesh, L., & Vijayakumar (2019). Monitoring and Control of Distribution Transformer. *International Journal of Engineering and Advanced Technology (IJEAT)*, Vol. 8, No. 6, pp. 112-114.
- Mali, P. V., Bhosale, S., Rulhe, V. K., & Giri, A. M. (2019). Real Time fault Alert System for Distribution Transformer Using IoT. *International Journal of Scientific Development and Research (IJSDB)*, Vol. 4, No. 4, pp. 143-147.
- Pathak, A. K., Kolhe, A. N., Gagare J. T., & Khemnar S. M. (2016). GSM Based Distribution Transformer Monitoring and Controlling System. *International Journal of Advance Research and Innovative Ideas in Education (IARIIE)*, Vol. 2, No. 2, pp. 349-351.
- Patil, V.A., Namrata S.K., & Shital, S. P. (2017). Transformer Monitoring and Controlling with GSM Based System. *International Research Journal of Engineering and Technology (IRJET)*, Vol. 04, No. 03, pp. 119-123.
- Rashmi, A. P., & Prajakta V. (2017). Transformer Parameter Monitoring Using GSM Module. *International Research Journal of Engineering and Technology (IRJET)*, Vol. 04, No. 03, pp. 2103-2107
- Saravana, M. K., Prasanna, K. R., & Sundarsingh, D. J. (2014). Monitoring and Protection of Remote Area Transformers Using GSM Technology. *International Journal of Engineering Research & Technology (IJERT)*, Vol. 3, No. 2, pp. 1392-1397.
- Sumit, K., & Chatpalliwar, A. S. (2015). Protection of Distribution Transformer Using Auto Protected System. *International Journal of Mechanical and Production Engineering*, Vol. 3, No. 3, pp. 13-16.



USE OF QUARRY DUST TO REPLACE SAND IN SANDCRETE BLOCKS

Auwalu Saidu¹, Ahmad Sani² and Aaron Samuel Kafinta³

Department of Civil Engineering Technology

Federal Polytechnic Bauchi

E-mail: auwalusaidu9@gmail.com¹, asani.cet@fptb.edu.ng² and skaaron@fptb.edu.ng³

ABSTRACT

The research was based on an investigation of the optimum quantity of quarry dust required to replace sand content in sandcrete blocks, which would yield best quality products. The cement was combined with fine aggregates in ratio of 1:3. The percentage replacements of sand by quarry dust were: 0%, 5%, 15%, 25%, 35% and 45% by volume of fine aggregate. Sieve analysis was carried out to classify the sand and quarry dust. Forty-five sandcrete blocks of 150mm × 225mm × 450mm were produced and tested. Compressive strength test and hygric property (porosity and sorptivity) analysis were conducted. From the results, an increase in compressive strength with the increase in quarry dust was observed. The compressive strength reached its optimum values at 15% replacement, and the values are: 2.18, 2.28, and 2.55N/mm² at the age of 7, 14, and 28 respectively. Beyond 15% replacement, increase in quarry dust decreases the compressive strength of the sandcrete blocks. Also, it was observed that, increase in quarry dust decreases porosity and sorptivity.

INTRODUCTION

Sandcrete blocks are masonry units manufactured from a mixture of cement sand and water. They are largely used as walling materials in construction of buildings and other infrastructures. Sandcrete blocks have been in use throughout West Africa for over five decades as a popular building material for load and non-load bearing walls and foundations (Abdullahi, 2006). Anthony et al. (2016) asserted that, blocks are moulded into various sizes and forms in Nigeria. The sizes are: 225mm × 225mm × 450mm, 150mm × 225mm × 450mm and 100mm × 225mm × 450mm; which may be either solid or hollow. Anosike and Oyeade (2012) opine that Block construction industry is a very important sector of the Nigerian economy. It plays critical role in a nation's economy such as Nigeria because of the transient trend in the national growth. Over 90% of physical infrastructures in Nigeria are being constructed using sandcrete blocks (Baiden and Tuuli, 2004). Oyeekan and Kamigo (2008) opine that sandcrete blocks are manufactured in many parts of Nigeria for a long time without any reference to suit local building requirements or good quality work. They further reported that, Standard Organization of Nigeria (SON) developed a reference document in the year 2000, in an attempt to enhance the best materials and manufacturing practice, which prescribed the minimum requirements and uses of different kinds of sandcrete blocks (NIS, 2000). Among the objectives of this NIS document are to ensure that all block manufacturers meet a minimum specified standard, as well as to control the quality of blocks produced by these manufacturers. Compressive strength of blocks is a measure of the blocks resistance to axial load application (Osuji and Egbon, 2016). The recommended strength by BS 2028 is: Mean strength, 3.45N/mm²; Lowest individual strength, 2.59N/mm². From specification, it implies that the least compressive strength of individual block must be at least 75% of the mean value. The Federal Ministry of Works and Housing (1979), in Nigeria, recommends a compressive mean strength of 2.1N/mm² and lowest individual strength of 1.7N/mm². The range of minimum strength of sandcrete specified in the Nigeria Industrial Standard is between 2.5N/mm² to 3.45N/mm² (NIS, 2000). However, the strength of sandcrete blocks is inconsistent due to the different production methods employed, duration of curing, sizes

of blocks and the properties of constituent materials (Abdullahi, 2005). Ettu et al. (2013) argue that increasing number of Nigerians in urban and sub-urban districts of the country cannot afford to pay for good accommodation. Academic research in recent years focuses on partial replacement of Portland cement or fine aggregate content by some suitable agricultural waste products, such as rice husk ash (RHA) and other materials like quarry dust, in the production of sandcrete blocks. These materials are cheaper to obtain, and could generally reduce the production cost of sandcrete blocks. This research therefore is aimed at investigating the strength and hygric properties of sandcrete block produced by partially replacing sand with quarry dust.

REVIEW LITERATURE

Osuji and Egbon (2016) evaluated the compressive strength of sandcrete hollow building blocks, with the sand fraction partially replaced with quarry dust. They used a range of 0%, 10%, 15%, 20% and 25% sand replacement with quarry dust in the cement: sand mix ratios of 1:6 and 1:3 for moulding blocks of size 225mm x 225mm x 450mm. These blocks were produced by machine compaction under a pressure of 3N/mm². Results indicated that for mix ratio of 1:6 at 28 days when 10% quarry dust partial replacement was applied, the compressive strength of the blocks was about 7% greater than that of blocks without partial replacement. Also, for the mix ratio of 1:3 at 28 days and 10% partial replacement with quarry dust, the compressive strength of the blocks was about 46% higher than that without partial replacement of the sand fraction. They also observed that strength of the blocks increases with increase in quarry dust partial replacement of sand. However, for the mix ratios employed, they noted that 15% partial replacement of sand with quarry dust gave an optimum compressive strength of 3.8N/mm² and 4N/mm² for the two mix ratios respectively. Therefore, they suggested that, the optimum replacement of sand with granite quarry dust as fine aggregates should be 15% of the sand fraction in hollow building blocks of the size and mix ratio adopted herein.

Olanigan et al. (2012) assessed the suitability of granite fines as partial replacement for sand in sandcrete block production. They used mix proportion (1:6) for batching in volume and cured by wetting the blocks daily. They carried out compressive strength test on the sandcrete block for each percentage of replacement on 7, 14, 21 and 28 days. The percentage of granite fines replacement used in the research were 0%, 5%, 10%, 15%, 20%, 25% and 100%. Result of their experiment showed that the inclusion of granite fines in the sand cement enhanced the compressive strength of sandcrete block. Sandcrete blocks made with 1:6 mix proportion using 15% granite fines replacement gave optimum compressive strength of 4.11 N/mm².

Oyekan and Kamiyo (2008) investigated the performance of hollow sandcrete blocks containing cement, sharp sand and granite fines in varying proportions to determine their structural and hygrothermal properties. They varied the percentage of granite fines by volume of the total fine aggregate in steps of 5% to a maximum of 30%. Results of the tests showed that the inclusion of granite fines in the sand-cement matrix has a very significant effect on the compressive strength of sandcrete blocks. It was also observed that, for both mix proportions, 15% granite fines content was the optimum for improved structural performance. The hygrothermal properties of the block with 15% granite fines content indicated it as the most compact.



MATERIALS AND METHODS

Materials

The following materials were used in producing the sandcrete blocks used in this research work:

Sand

Clean sharp sand, free from waste stone and impurities were used in the production of the sandcrete blocks used in this research work.

Cement

Dangote brand of Ordinary Portland cement (OPC) of grade 42.5N/mm² was used.

Water

Portable water which is free from suspended particles, salts and oil contamination was used throughout this study.

Quarry dust: The quarry dust was obtained from the Triacta's quarry site in Bauchi.

Mixing

In this study, the manual method of mixing was used. The cement and sand were mixed in a dry form and water was added in spray form in moderate proportions to allow the cement to hydrate and excess of water was avoided that would have caused shrinkage and distortion of block on drying. Water/cement ratio of 0.5 and mix ratio of 1:8 (one part of cement to eight part of sand) were adopted for this research work.

Compaction Methods

The blocks were compacted manually with the aid of a wooden rod. The blocks were of sizes 150 mm x 225 mm x 450mm

Curing

Curing was employed to maintain satisfactory moisture content and allow proper hydration and hardening of the sandcrete blocks. The blocks were cured by water spraying for the period of the 7, 14 and 28 days after which they were tested for compressive strength.

Determination of the Compressive Strength of Block Samples

The Compressive strength tests were carried out at the end of 7, 14, and 28 days of curing the sandcrete blocks using compressive testing machine. The test was carried out at the Concrete Laboratory of Federal Polytechnic, Bauchi, Bauchi State Nigeria. A total of Forty-five numbers of blocks were subjected to compressive strength test and the strength was computed using equation (1)

$$f_c = \frac{P}{A} \quad \dots \quad (1)$$

Where:

f_c = Compressive Strength (N/mm²),

P = crushing load (kN), and

A = cross sectional area (mm²).

Sorptivity and Porosity test

Sorptivity is the material property which characterizes the tendency of a porous material to absorb and transmit water by capillarity. The cumulative water absorption (per unit area of the inflow surface) increase as the square root of the elapsed time (t). The sorptivity is calculated using equation (2)

$$S = l/t^{1/2} \quad \dots (2)$$

Where:

S = sorptivity (mm)

T = elapsed time (mins)

$l = \Delta w / Ad$

Δw = change in weight = $W_2 - W_1$

W_1 = Oven dry weight of the sample

W_2 = weight of sample after 30 mins capillary suction of water in grams

A = surface area of sample through which water penetrated

d = density of water

RESULTS AND DISCUSSION

Physical Properties of the Materials Used

The physical properties of both aggregate (sand and quarry dust) were determined in accordance with BS 1377-9 (1990). These include: specific gravity, bulk density, water absorption and sieve analysis (Grain size distribution as shown in FIG. 1 and FIG. 2). Table 1 displays the physical properties of sand and quarry dust. It was observed that, sand grains have higher specific gravity in contrast. Quarry dust has higher bulk density, because it contains little proportion of gravel. Quarry dust absorbs and holds more water due to presence of large proportion of fine sand. Particle size analysis reveals that quarry dust is well graded sand and the river sand is poorly graded.

Table 1: Physical properties of materials used

Properties	Specific gravity	Bulk density(kg/m ³)	Water absorption	Particle size distribution
Sand	2.61	1460	0.19	$C_u=4.5, C_z=0.47$
Quarry dust	2.55	1796.30	0.24	$C_u=10, C_z=1.11$

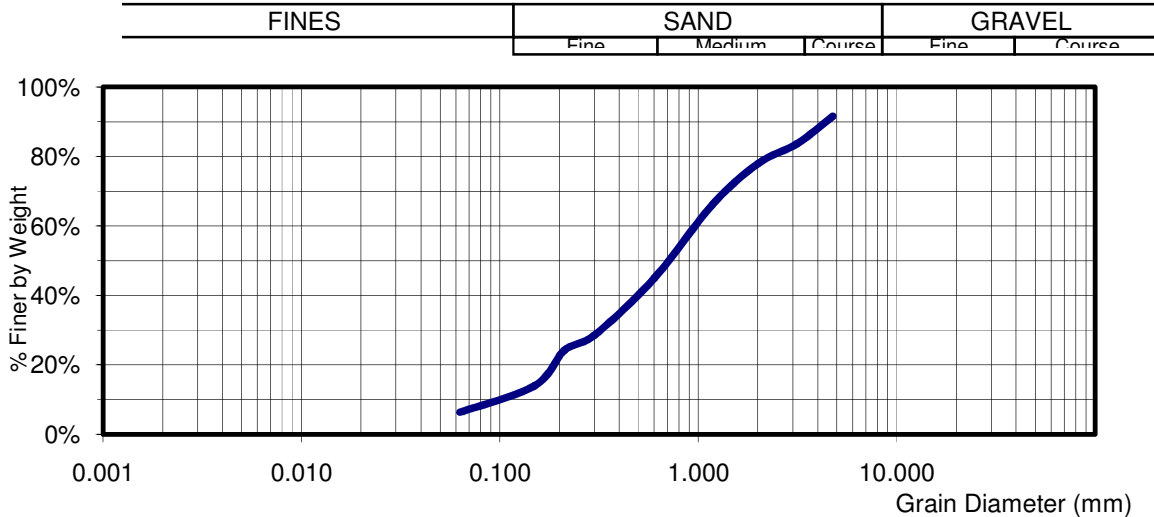
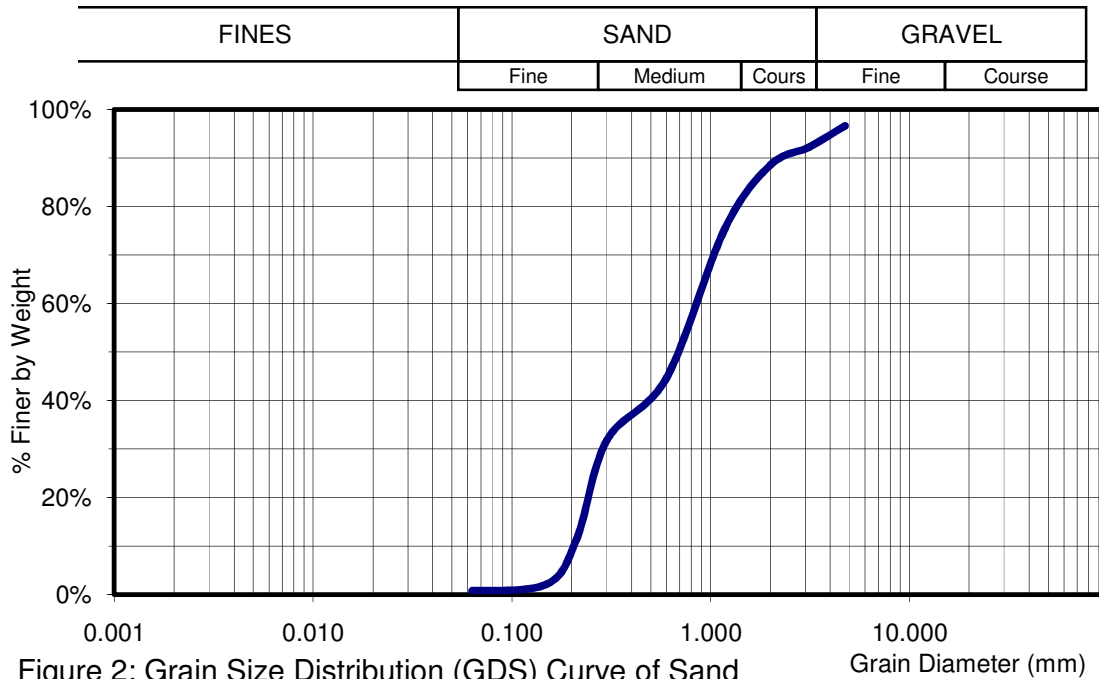

Compressive Strength

Results of compressive strength test are as presented in Figures 1 shows plots of average compressive strength against quarry dust percentage replacement for 7,14, and 28 days curing period. The result shows that addition of quarry dust to replace sand in sandcrete blocks improves the compressive strength. In addition, 15% partial replacement of sand by quarry dust yields optimum strength of 2.55N/mm² at 28 days,

Use of Quarry Dust to Replace Sand in Sandcrete Blocks

which is 37% increase in comparison to 0% replacement and meet the Nigerian Industrial Standard specification (NIS, 2000). Beyond 15% increase in quarry dust content reduces the strength of the sandcrete blocks. The maximum compressive strength at the age of 7 and 14 days are 2.18 and 2.28 N/mm² respectively.

The enhanced strength obtained is perhaps due to better particle packing and the consequent reduction in the volume of the voids. Furthermore, the addition of granite fines improved the grading of the fine aggregate content thereby improving the workability of the mix and enhancing the compressive strength. This agrees with findings of Osuji and Egbon (2015), Olanigan et al. (2012) and Oyekan and Kamiyo (2008).

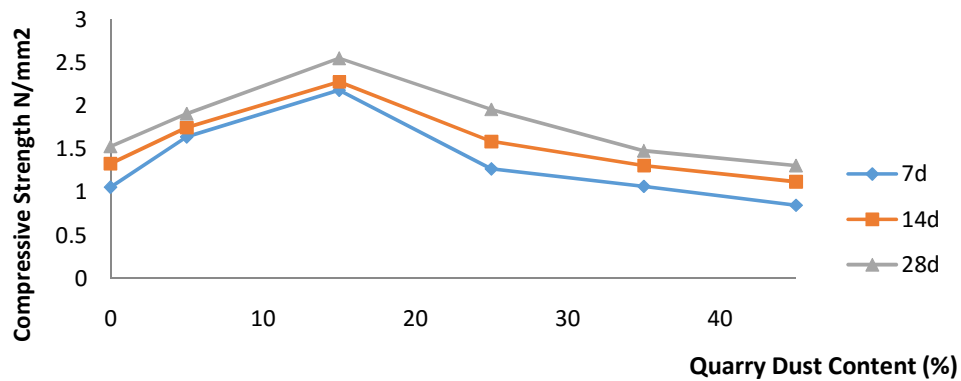

Fig.3: Variation of Compressive Strength and Quarry Dust content

Hygric Properties

For the hygric properties of the sandcrete blocks with fine aggregates partially replaced by quarry dust; the results of porosity and sorptivity are presented in Figure 4 and Figure 5. It was observed that, increase in quarry dust results in decrease in porosity in sandcrete blocks. This is due to enhancement in the gradation of the particle. Also, increase in curing age results in decrease in porosity of the sandcrete blocks, which is due to proper cementation of the particles. Also, from Figure 5, it was observed that, increase in quarry dust decreases sorptivity effects, which is due to reduction in void spaces. It was also observed that, increase in curing age decreases sorptivity effects, which is due to binding effects of the cement.

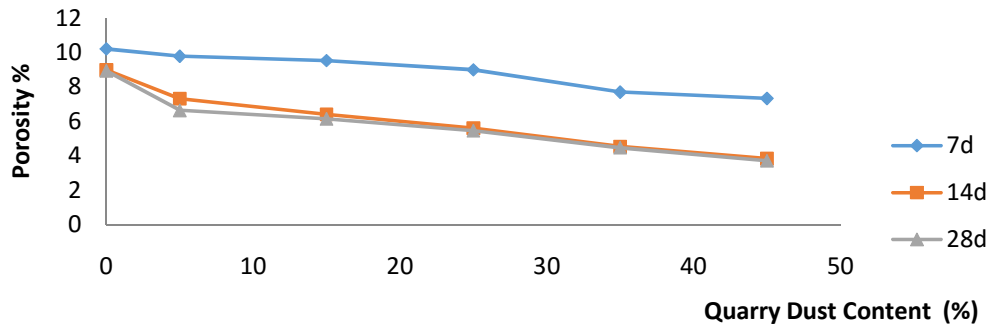

Fig.1.3 Graph of Porosity Vs Quarry Dust content

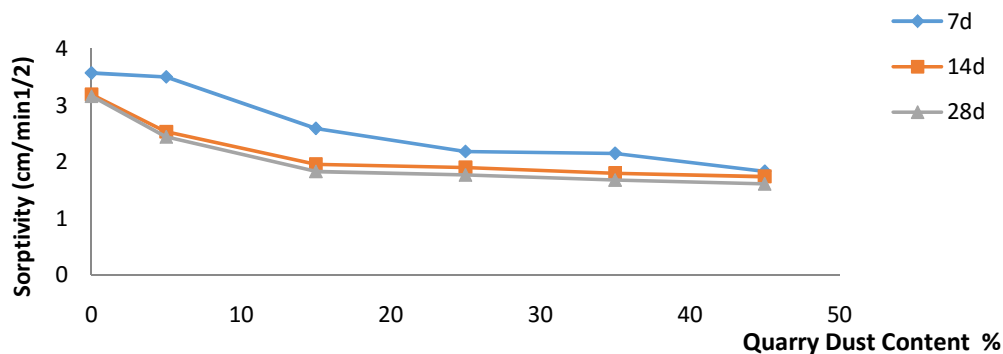

Fig.5: Variation of Sorptivity with Quarry Dust content

CONCLUSION

Based on the results obtained, the following conclusions were made:

- (i) Quarry dust improves the compressive strength of the sandcrete blocks with an optimum strength at 15% quarry dust
- (ii) Increase in quarry dust results in decrease in porosity and sorptivity effects. At 15% granite fines content shows the most effective replacement for the structural performance.

REFERENCES

- Abdullahi, M. (2006). "Properties of Some Fine Aggregates in Minna, Nigeria and Environs," Leonardo Journal of sciences, 8, 1-6
- Anthony B.S., Olabosipo I. F. and Adewuyi P. A. (2015). "Sandcrete block and Brick Production in Nigeria - Prospects and Challenges," IJAR International Journal of Environmental Research Vol. 1 No.4
- Baiden, B. K. and Tuuli, M. (2004). "Impact of quality control practices in sandcrete blocks production," Journal of Architectural Engineering, 10(2), 55-60.

- L. O. Ektu, F. C. Njoku, C. T. G. Awodiji, A. P. C. Amanze and M. C. Arimanwa (2013). "Variation of OPC-Rice Husk Ash-Saw Dust Ash Composites Strength with Mix Proportion," *International Journal of Engineering Sciences & Research Technology*, 2(8), ISSN: 2277-9666.
- Federal Ministry of Works Part 2 (1979). "Sandcrete Block Specifications"
- G. L. Oyekan and O. M. Kamiyo (2011). "A study on the engineering properties of sandcrete blocks produced with rice husk ash blended cement," *Journal of Engineering and Technology Research* Vol. 3(3), pp. 88-98.
- M. Abdullahi (2006). "Compressive strength of sandcrete blocks in Bosso and Shiroro Areas of Minna, Nigeria." *AUJ.T.9* (2), pp. 126-132.
- Nigerian Industrial Standard, NIS 87, (2004) "Standard for Sandcrete Blocks in Nigeria," Timmy Press, Federal Ministry of Industries Lagos (draft).
- Nigerian Industrial Standard, NIS 87, (2000). "Standard for Sandcrete Blocks," Standards Organization of Nigeria, Lagos, Nigeria.
- Osuji S. O. and Egbon B.N. (2015), "Optimizing Compressive Strength of Hollow Blocks from Granite Quarry Dust and Sand," *Nigerian Journal of Technology*, 34(3) Pp 478-483.
- O. S. Olaniran, O.M. Afolabi and O.M. Okeyinka (2012). "Granite Fines as a Partial Replacement for Sand in Sandcrete Block Production," *International Journal of Engineering and Technology* Volume 2 No. 8.



DESIGN AND IMPLEMENTATION OF A SMART PARKING LOT

J. A. Ogbekhiulu¹ and A. M. Epemu²

¹Department of Electrical and Electronic Engineering,
College of Engineering and Technology,
Federal University of Petroleum Resources, Effurun
Email: ogbekhiulu.joseph@fupre.edu.ng

ABSTRACT

This paper present the design and implementation of a smart parking lot. The design involves three parking lots and a prototype parking environment constructed with wood. The design was achieved by programming a PIC 16F84a using C program that receives its input from different infrared ray sensor located at the different entrance of the parking lots, then processes the input and sends the output to a seven segment display LCD. The design is a prototype that is intended to solve the issues of proper parking in urban areas, business centers, and University environment. It reduce the stress caused by indiscriminate parking of cars and any form of danger or insecurity to cars and owners. The prototype design was simulated in Proteus environment and then implemented. The results obtained indicates that parking of cars in urban areas, business center and University environment could be controlled and indiscriminate parking and theft of cars could be eliminated.

Key words: Prototype, simulated, parking, programing, environment

INTRODUCTION

The population of the world is continuously on the increase and towns and cities have grown up around their public transport system. The increasing population and expanding urban centres have been accomplished by increasing car ownership and increasing demand for movement for various purposes. Regardless of income or social status, the condition under which people travel have become more and more difficult and for some, absolutely intolerable. Demand for transport and travel intensity tends to increase sharply with the growing size of a city and town especially when the city centre or major centres of activity continues to grow in terms of both size and employment. Parking in public areas can be very tasking with little or no form of security because it is fraught with all sorts of hazards created by either humans or lack of parking structures. In order to reduce the stress of parking and any form of danger or insecurity to cars and owners, adequate parking facilities must be provided to meet up for the demand of parking. (Anthony, 2016) Parking is going through a disruptive shift as technology enables new ways of maximizing utilization of parking spaces, and drivers become more demanding of using apps and other services to find available spaces. Technological advancements have led to the advancement and prevalence of Wireless Sensor Networks (WSN) in many of man's activities. The WSN consists of numerous sensor nodes that are organized to establish a network via a wireless communication module that is equipped on the nodes. The sensor nodes are equipped with different sensors, computation units, and storage parts to collect cooperatively, process and provide sensory data for localization and surveillance. WSN technology has been applied in both civil and military applications such as intelligent buildings, smart homes among others. This paper presents the design and implementation of a smart car parking lot (Alhamsi, 2016). The smart car parking lot is an IOT (Internet of Things) application, the IOT has the potential to transform the entire parking lot by solving real problems people face each day as regards parking of cars. With the proper connections and data, the internet of things can solve traffic congestion issues and reduce noise, crime and pollution. A parking lot or car lot is a cleared area that is



more or less level and is intended for parking vehicles. The term usually refers to a dedicated area that has been provided with a durable or a semi-durable surface. Parking lots are usually paved with asphalt. Some are paved with concrete while some others are paved with interlocking tiles. There are even lots that are paved with gravel. Parking lots can be small with parking spaces for a few vehicles or very large with spaces for thousands of vehicles, or any size in between. Small parking lots are usually built near buildings for small businesses or a few apartments. Larger parking lots can be built for larger businesses or those with many customers, institutions such as schools, churches, offices, hospitals, museums or other tourist centres, rest areas, strip malls, or larger apartment buildings. Some businesses centres, institutions, or other buildings may have several parking lots if a single large lot cannot accommodate their parking needs. Large and very large parking fields can be built for stadiums, airports, Malls or shopping centres with multiple businesses, large schools or Universities, convention centres or fair grounds, theatres, or workplaces with many employees such as factories, plants or large institutions. Often several businesses, office/apartment buildings, or institutions may use one or more parking lots in common for their convenience. Parking lots have their own special type of engineering designs. (Enokela, 2013).

REVIEW OF EXISTING LITERATURES

Kurogo, (1996) presents the implementation of Parking Guidance and Information System (PGIS) which encompasses two major categories. The PGIS can either include the entire city area or function only within the car park facility. Setting aside the differences; both the PGIS offer similar advantages. Both provides information which aids the decision-making process of the drivers in reaching their destination and aids them in locating a vacant parking space within the car park facility. The city wide PGIS is indeed helpful in assisting drivers to car park with vacant parking spaces via the information occupancy status for various car parks around the city as well as other relevant information. On the other hand, guidance in locating the vacant parking space within the car park is ultimately provided by PGIS implemented within the car park.

Vehicle detection sensors are commonly installed at entrances, exits and/or individual parking space to detect vehicle. Indicator lights integrated with sensors are also sometimes installed at every individual parking space within the parking facility. The occupancy status detected by the sensors can either be occupancy of each individual parking space or in terms of vehicles counts in the car park depending on the installation of the sensors. The control centre gathers and processes the traffic and occupancy information as well as controls the display of information for drivers whereas the telecommunication network facilitates the transfer of information among the other three modules. (Mouskos, 2007)

With the advent of advanced technologies, the implementation of devices such as microcontroller and Field Programmable Gate Array (FPGA) are incorporated for faster information processing. Not only that, the telecommunication network no longer dependent on conventional electrical wiring but wireless technologies are able to be utilized. Researchers such as Wang and Chen (2007), Bi *et al* (2006), Liu *et al* (2006), Tang *et al* (2006), Lee *et al* (2008) and Seong-Eun *et al* (2008) have all used wireless network for data transfer in the implementation of their proposed parking guidance system.

Shaheen, (2006) present the functionality of transit-based information system which is implemented in countries such as France, Germany, Ireland, Japan, Switzerland, the United Kingdom and the United States is actually similar to PGIS. The difference exists in the fact the Transit Based Information System concentrates

on guiding user to park-and-ride facilities. It provides real-time information on the status of each car park and public transportation such as the schedules and traffic condition to the public. The additional information provided enables the patrons to plan for transit in advance without getting into any inconvenience (Chinrungrueng, 2007). Among its benefits includes increase in the utilization of public transportation as the primary means of transportation as they can leave their vehicle in the car park and switch to public transportation with ease. This will indirectly lead to an increase in the transit revenue (Shaheen, 2006), (Chinrungrueng, 2007). Horner and Groves (2007) in their network flow-based technique introduced improves on the conventional spatial model used in determining the park-and-ride facility location by taking into consideration the traffic flow and works in reducing the vehicle miles travelled by maximizing the interception of vehicle during the beginning stage of the journey. Shaheen, 2006 proposed an E-parking system which provides an alternative for persons to enquire the availability and/or reserve a parking space at their desired parking facility to ensure the availability of vacant car park space when they arrive at the parking facility. The system can be accessed via numerous methods such as SMS or through the internet. Some of the additional benefits of using the E-parking system aside from those collectively gained by smart parking system is that it can be extended easily to incorporate the payment mechanism of smart payment system whereby payments by the persons are made hassle free using the technologies discussed previously. Customized information can also be provided to the persons either before or during their trip to the car park. In a study by Inaba *et al* (2001), reservations can be made through the utilization of mobile phones or any reservation centres convenient to the patrons. On the other hand, the study by Hodel and Cong (2004) revealed options of using the internet via Wireless Application Protocol (WAP) enabled mobile phones, Personal Digital Assistants (PDAs) and even conventional computer in addition to SMS service for the drivers in accessing the information as well as making reservations. Teodorovic *et al* (2006) takes the implementation a step further by incorporating fuzzy logic in decision making whereby the parking reservation request can either accepted or rejected. It also facilitates the enforcement of tariff classes to enable the car park operators to maximize revenue. More sophisticated designs proposed which requires the use of smart cards or magnetic cards (Inaba, 2001) and Bluetooth (Hodel, 2004) are also implemented in granting access to the patrons. It can also be implemented together with Smart Payment System payment schemes such as cards (Inaba *et al*, (2001); Hodel and Cong (2004)), pre and post-paid methods as well as m-payment (Hodel and Cong (2004)) are utilized. Mathijssen and Pretorius (2007) in their work introduced a three-level software design which includes: Logical Layer (LL), Safety Layer (SL) and Hardware Abstraction Layer (HAL) to enforce correct and efficient storage of vehicles in a safe manner. As the car park facility is designed with conveyer belts, rotatable lifts and shuttles, it has to be coordinated to ensure successful and safe placement and retrieval of the vehicle.

METHODOLOGY

The methodology employed in this paper uses an Arduino Mega as the microcontroller unit to which the servo motors, LCD, object counter using IC 555 and seven segment display, and IR sensors SR211C are interfaced. The LCD displays the availability of the space, the seven segment display keeps the check of the number of cars entering and exiting the parking space, the servo motor helps as gate for the entry and exit of the cars. The IR sensors detect the availability of the parking space. The block diagram of the car parking lot prototype system is shown in figure 1.

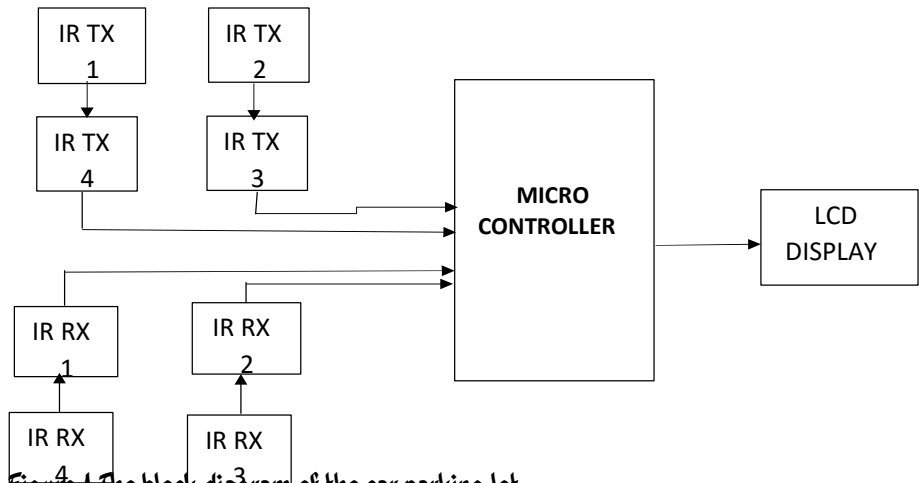

Figure 1 The block diagram of the car parking lot
 The working of the system is divided into four sections;

SENSING UNIT IR TRANSMITTER & RECIEVER

The Car Parking monitoring system module was implemented using 4 transmitters and 4 receivers. Infra-Red transmitters will be used because infrared beams are not visible to human eyes. Transmitters used are IR LEDs. IR LED (Transmitter): Light Emitting Diode which is commonly known as LED is used as IR transmitter. TTL 38 can be used as an IR transmitter. Infrared receiver will also be used which is an active low device i.e. it gives low output when it receives the Infrared rays. These are the basic components for the automatic A.C. supply switching. Here we have used 38 kHz infrared IR receiver for detecting if a car has entered or left the slot in which we intend to switch the supply. These detector modules need to have infrared rays of 38 kHz which we have given through the IR LEDs via a 555 timer. Two sensors will be used for the car counter. Each will consist of two transmitters and one receiver. Transmitter will be placed at one side of the door while receiver will be at the other side. The other alternative for infrared trans-receiver is optical sensor i.e. IR but the disadvantage is that it can be affected easily by the sun light or other lights. So, there is possibility of false triggering. Also, the disadvantage of using special color sensors like LASER beam is that it is visible to normal human eyes. To overcome all these challenges, infra-red sensor will be used for the purpose of car counter module. IR Receiver: We have used TSOP 1738 as an IR Receiver. This receiver requires a square wave of frequency 38KHz at the input. It is an active low device, that is, it gives low output when it receives IR rays at the input. This will be incorporated in the design.

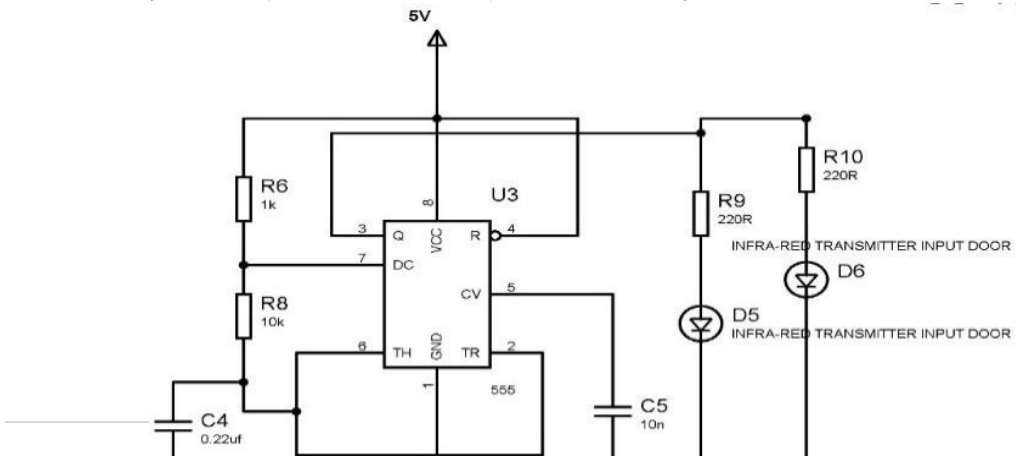

Figure 2 Circuit diagram of the sensor unit

MICROCONTROLLER

UPA (UnParking Allowed): - Whenever parking is possible, this LCD displays. It means that any vehicle can be parked if no new vehicle is parked or entering into the parking area. If vehicle is entering into the Parking area, then the signal is sent by IR Sensor to the AVR Controller. AVR Controller sends information to the IR Sensors located at the parking slots so that no vehicle can be parked during the parking of other vehicle and hence collision is avoided between two vehicles. **PNA (Parking Not Allowed):** - Whenever all the parking slots are full with the vehicles then this LCD displays a message which indicates that Parking is not allowed. **FPS1 (Free Parking Slot 1):** - If Parking lot No. 1 is free, then this LCD displays to show that Parking lot No. 1 is free and Parking can be possible at lot No. 1.

FPS2 (Free Parking Slot 2): - If Parking lot No. 2 is free, then this LCD displays to show that Parking lot No. 2 is free and Parking can be possible at lot No. 2.

FPS3 (Free Parking Slot 3): - If Parking lot No. 3 is free, then this LCD displays to show that Parking lot No. 3 is free and Parking can be possible at lot No. 3.

Whenever any vehicle arrives at the entrance of the Parking lot central processor receives the signal from the IR Sensor nodes and shows the status of Parking at the entrance. It also communicates with the IR Sensors located at the Parking lots so that no vehicle can be unparked during the arrival of the new vehicle at the Parking area and collision of two vehicles can be avoided. The Microcontroller selected is PIC18F2620. It has 8-bit CPU, memory, timers, counters, interrupt controller and serial I/O are highly integrated on single chip. It is a 28-pin IC. It has 4-byte input-output port, EEPROM of 4KB and RAM of 128 bytes.

DISPLAY SECTION

The LCD is used for the display purpose. It is a 16char×4-line LCD. It has a viewing Area of 66 x 16mm, character size of 2.96 x 5.56mm, character pitch of 3.55 x 5.94mm, character font of 5x7 dots and dot size of 0.56 x 0.66mm. It has 96 inbuilt ASCII characters, 92 special characters and 8 custom characters. 16char × 4-line LCD can also be used but since our requirement is of 2 lines only hence, we have used this LCD. Here an array of resistor is used with 8 resistors of 4.7K each used as pull up resistors. These are standard values of the pull-up resistor. A pot of 4.7K is also used for contrast adjustment. We can also use any other value pot. Display of parameters is an important part of system as it enables us monitor real time parameters. This happens by sending data by AT89S51 (port1) to LCD (pin 7-14). The data to be read or to be written is decided by control lines (pin 4, 5, 6) of LCD which gets its signal from software instructions of AT89S51. This interface diagram shown in figure 3.3 shows us the connection of an LCD to microcontroller. LCD



consists of 8 data lines which can be either a command or a data. An entire port is used for sending data to the LCD by microcontroller. Three other pins are also used for handshaking purposes.

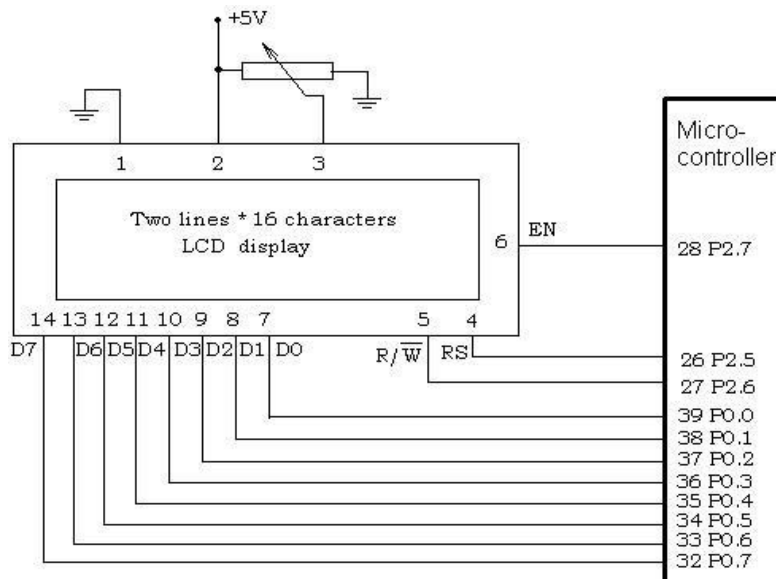

Figure 3. Circuit connection of LCD to microcontroller

IC555 CONFIGURATION

In this paper IC555 is connected as an Astable Multivibrator. The threshold input is connected to trigger input. Two external resistances R_a , R_b and capacitor C is used in the circuit. The circuit has no stable state. The circuit changes its state alternately. Hence the operation is called free running non sinusoidal oscillator. When the flip flop is set, Q is high which drives the transistor Q_d into saturation and the capacitor gets discharged. Now the capacitor voltage is nothing but the trigger voltage. So, while discharging, when it becomes less than $1/3 V_{CC}$, comparator 2 output goes high. This resets the flip flop hence Q goes low Q goes high. The low Q makes the transistor off. Thus, capacitor starts charging through the resistances R_a , R_b and V_{CC} . As total resistance in the charging path is $= (R_a + R_b)$. The charging time constant is $(R_a + R_b) * C$. Now the capacitor voltage is also a threshold voltage. While charging threshold voltage increases. When it increases $2/3 V_{CC}$, then the comparator 1 output goes high which sets the flip-flop. The flip flop output Q becomes high and output at pin 3 i.e. Q bar becomes low. High Q drives transistor Q_d into saturation and capacitor starts discharging through resistance R_b and transistor Q_d . Thus, the discharging time constant is $R_b C$ when capacitor voltage becomes less than $1/3 V_{CC}$, comparator 2 output goes high resetting the flip flop. This cycle repeats. Thus, while capacitor is charging output is high while when it is discharging output is low. Here we are designing for 200KHz frequency. The flowchart of the system is shown in figure 4 while figure 5 shows the complete circuit diagram of the car parking lot system.

Design and Implementation of a Smart Parking Lot

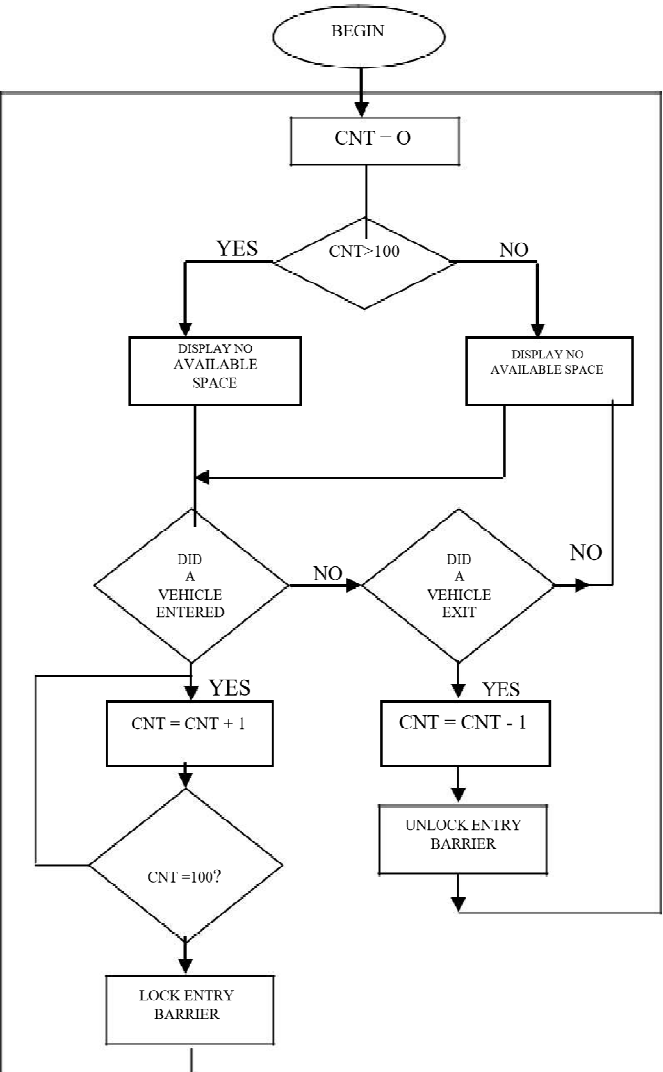

Figure 4. The flow chart of the prototype parking lot

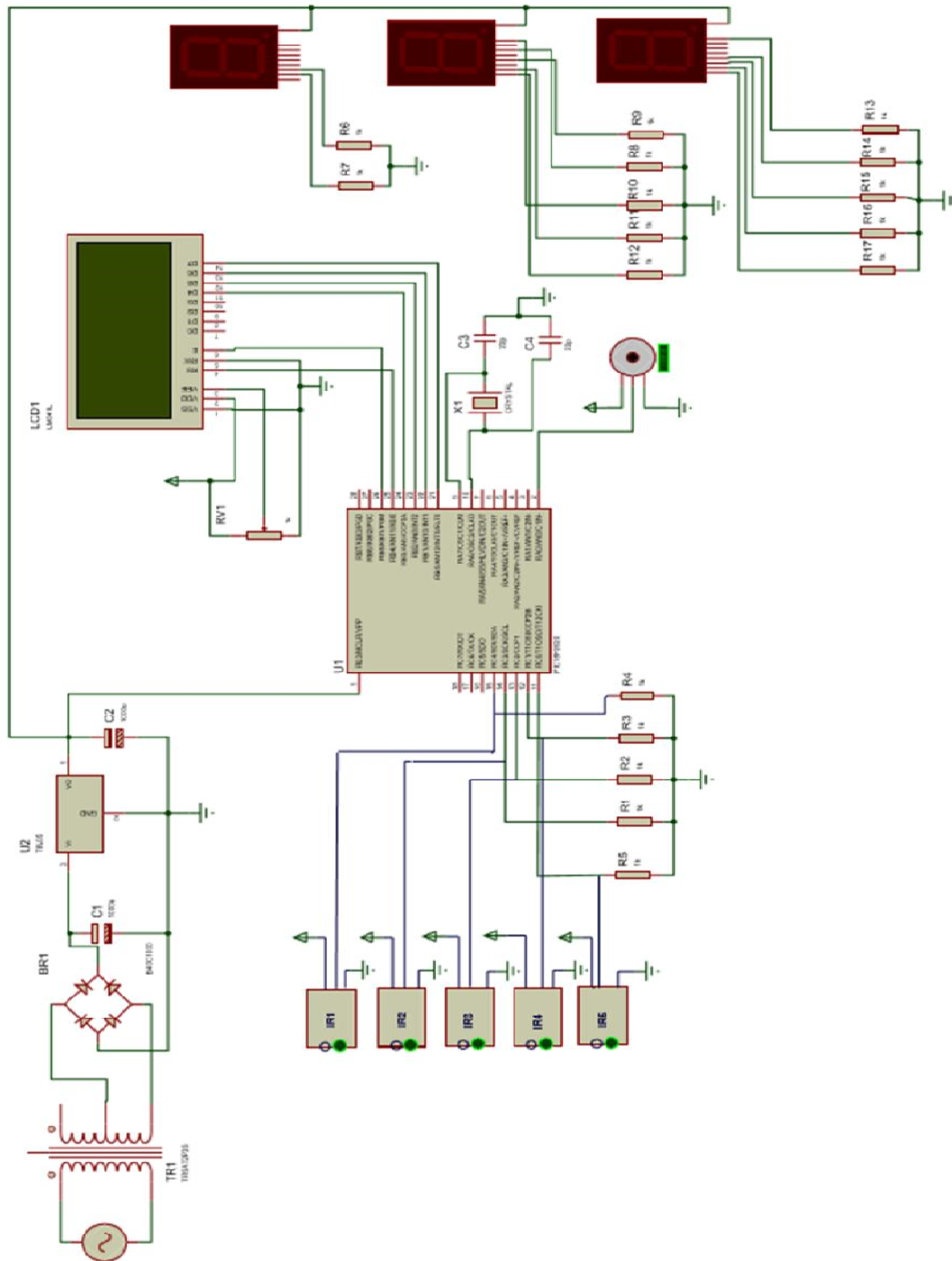

Figure 5 System Circuit Diagram

MODE OF OPERATION

Figure 5 is the complete circuit diagram of the automated car parking lot system. The system have different IR sensor installed to monitor the presence of car at the gate and at the parking space, and open the gate

automatically via a servo motor when it detects the presence of a car in a close range within the sensor environment. The system is connected to AC mains which has a voltage of 220VAC, which was then stepped down by a step-down transformer, fed to a rectifier circuit to produce a DC voltage and then passed through the filtering circuit to remove ripples, and finally to a voltage regulator to produce a constant DC voltage of 5 volts. This 5V DC is then supplied to power up the LCD, IR obstacle sensors, and servo motor and to the microcontroller, while 5VDC is directly fed to the seven segment circuit. LCD is connected to RB0 – RB5, servo motor is connected to RA0, and IR obstacle sensors is connected to RC0 – RC4. The system is designed in such a way that when power is supplied to the unit, the IR sensors connected to RC0, RC1, RC2, RC3 and RC4 sends an infrared wave around the system. When the IR sensor mounted at the gate for motion sensing senses the presence of a car close to the gate, it sends a command to the control unit, which triggers the IR sensor connected to RC0, RC1 and RC2 to check if there's any car at the parking lot. If the car lot is not filled the control system processes this signal and triggers the servo motor (M1) to rotate in a clockwise direction at an angle of 0 – 180 degrees by sending a logic 5V to the servo motor circuit through RA0 to conduct and after about 5secs the microcontroller sends 0V logic to the service motor circuit by making RA0 to conduct indicating a polarity reversal to rotate the motor in an anticlockwise direction and the gate closes. If the park is filled up and a user tries to access the parking lot, a visual warning will display on the liquid crystal display (LCD) informing the user that the park is not accessible and the gate will remain lock.

CIRCUIT IMPLEMENTATION

The electronic circuit was implemented on a printed circuit. All components on the hardware were connected as shown in the circuit diagram of figure 5 and permanently soldered to the board. The first stage involved the soldering of the circuit and the next involved making the munt of the whole system. First the layout was modelled using AutoCAD. The actual work was done using wood. The wood was cut in different sections and the pieces were then put together using glue and nail where appropriate as shown in figure 6. Next the circuit board was mounted on the wooden frame, the circuit was fastened to the board using some nails. All the connections were made by extending the wires and then placing the components in their right position as shown in figure 7.

After testing and troubleshooting of the system, the designed system was constructed on a Vero board and then re-tested, and altered where necessary until it worked as desired. The program for the PIC16f84a was written in C language and compiled with the MikroC Pro compiler software, after which it was simulated on Proteus electronic workbench being programmed into the microcontroller. Proteus is a virtual system modelling and circuit simulation application and the simulations gave an idea of how the code would function in the hardware but the final inference could only come from testing the code on the hardware it was programmed for. However, all errors discovered on Proteus were corrected until the code worked perfectly as expected on the virtual circuit. When placed in the hardware, several anomalies were observed in the performance of the system, and the program was refined until its interaction with the rest of the hardware was stabilized. Figure 8 shows the car parking lot with only one car parked while the other lots are vacant for any incoming car to the parking lot. Once the park is filled up as shown in figure 9 and a user tries to access the parking lot, a visual warning will display on the liquid crystal display (LCD) informing the user that the park is not accessible and the gate will remain lock as shown in figure 10.



International Journal of Engineering and Emerging Scientific Discovery
ISSN: 2636-7260 (Print); 2636-7269 (Online)
Volume 7, Number 1, March 2022
<http://www.casimediapublishing.com>

FLOOR DIMENSIONS

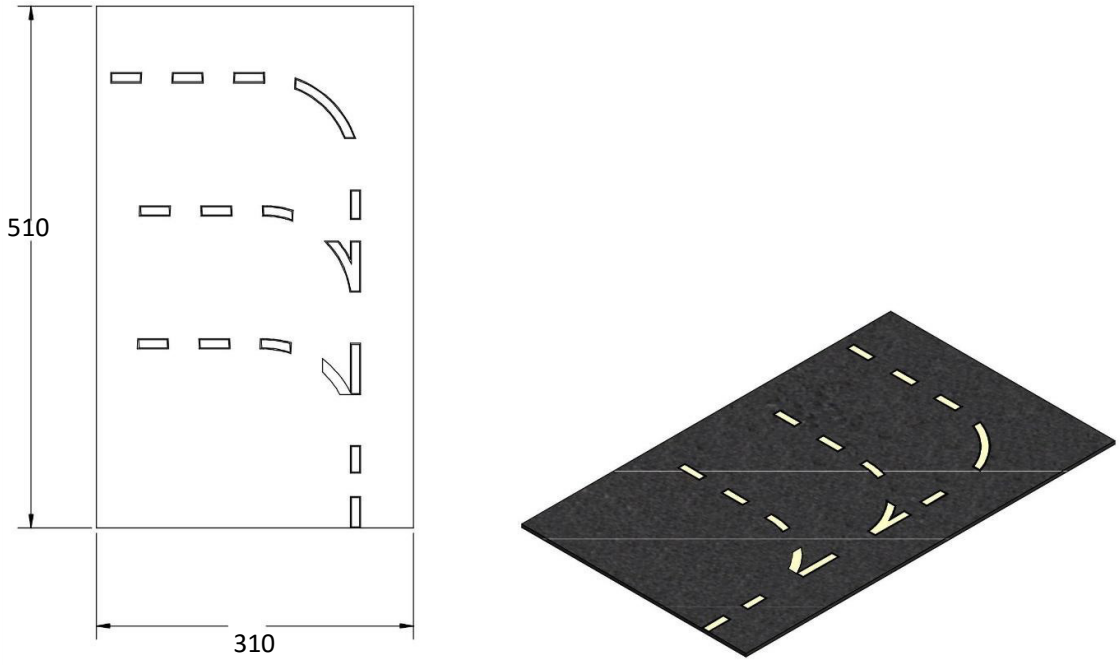

FENCE DETAILS

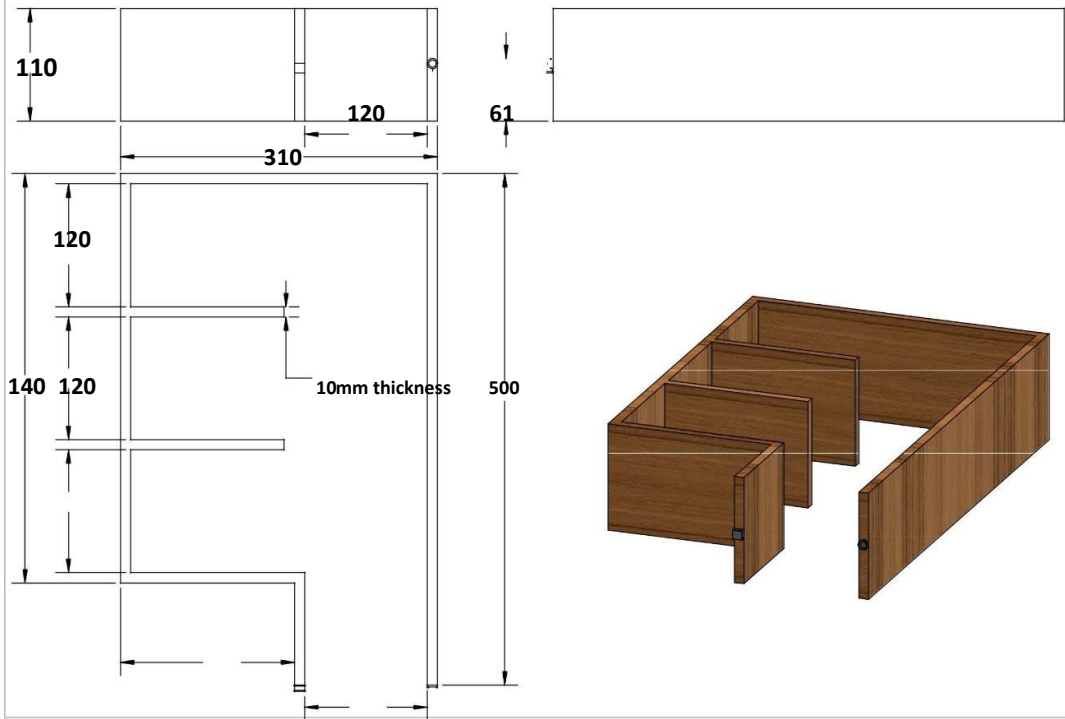

Figure 6 Floor and fence dimension of the wood work

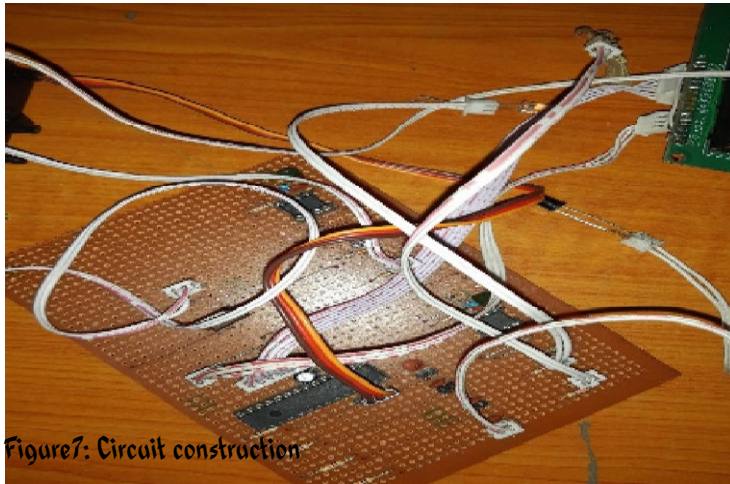

Figure 7: Circuit construction

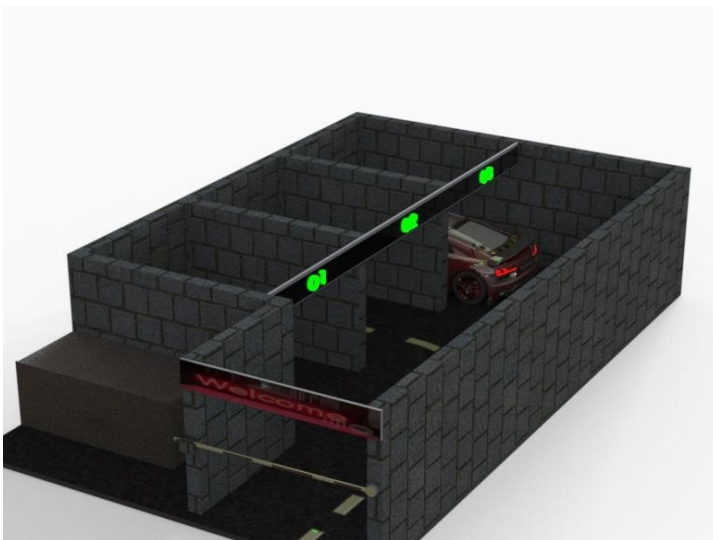

Figure 8: Diagram showing the parking lot with only one parking space occupied



Figure 9: Car parking lot fully occupied



Figure 10: LCD display showing that the parking lot is fully occupied

CONCLUSION

In this paper, the various types of smart parking system have been presented and discussed. From the various smart parking system presented, it was observed that the automatic car parking lot is more efficient in alleviating the traffic problem that arises especially in the city area where traffic congestion and the insufficient parking spaces are undeniable. It does so by directing patrons and optimizing the use of parking spaces.

REFERENCES

- Alhamsi H., S., (2016). "Smart Car Parking System", *International Journal of Science and Technology*, vol. 6, issue no. 7, pp161-166.
- Anthony N., E., Peace F., A., Paul O., A., (2015). "Challenges of Car Parking Design in Nigeria", *International Journal of Innovative Technology and Exploring Engineering*, ISSN: 2278-3075 Volume 4, Issue 10 PP
- Bi Y., L., (2006). "A parking management system based on wireless sensor network", *Acta Automatica Sin.*, vol. 7, issue 3, pp877-968.
- Chinrungrueng J., U., (2007). "Smart parking: An application of optical wireless sensor network", *Proceedings of the International Symposium on Applications and the Internet Workshops*, vol. 3, issue 7, pp66-69.
- Enokela J., A., (2013). "An automated parking lot administrator", Benue state: Electrical Department, University of Agriculture Markurdi.
- Hodel T., A., (2004). "PSOS, parking space optimization service", *Proceedings of the 4th Swiss Transport Research Conference*, vol. 7, issue 3, pp1-22.
- Horner M., A., (2007). "Network flow-based strategies for identifying rail park-and-ride facility locations", *Soc. Econ. Plann. Sci.*, pp255-268.
- Inaba K., M., (2001). "Intelligent Parking Reservation Service on the Internet", *Proceedings of the SAINT-W, Symposium on Applications and the Internet-Workshops*, vol. 8, issue 8, pp159-164. San Diego, CA, USA.



- Kurogo H., K., (1995). "Concept of a Parking Guidance System and its Effects in the Shinjuku Area- Configuration, Performance and Future Improvement of System", *Proceedings of the Vehicle Navigation and Information Systems Conference, 1995. In conjunction with the Pacific Rim TransTech Conference, 6th International VNI, A Ride into the Future*, vol. 4, issue 4, pp67-74.
- Lee S., D., (2008). "Intelligent Parking Lot Application Using Wireless Sensor Networks", *Proceedings of the International Symposium on Collaborative Technologies and Systems*, vol. 5, issue 3, pp48-57.
- Liu Q., H., (2006). "Design and Development of Parking Guidance Information System Based on Web and GIS Technology", *Proceedings of the 6th International Conference on ITS Telecommunications*, vol. 4, issue 4, pp1263-1266).
- MathijssenHad A., A., (2007). "Verified Design of an Automated Parking Garage", *Lecture Notes Computer Science*, pp165-180.
- Mouskos K., M., (2007). "Technical Solutions to Overcrowded Park and Ride Facilities". New York: University Transportation Research Center-Region 2, vol. 6, issue 1, pp263-269.
- Seong-Eun Y., C., (2008). "PGS: Parking Guidance System Based on Wireless Sensor Network", *Proceedings of the 3rd International Symposium on Wireless Pervasive Computing*, vol. 3, issue 5, pp218-222.
- Shaheen S., C., (2005). "Smart Parking Management Field Test: A Bay Area Rapid Transit (BART) district parking demonstration", retrieved from http://pubs.its.ucdavis.edu/download_pdf.php?id=44.
- Tang V., Y., (2006). "An intelligent Car Park Management System Based on Wireless Sensor Networks", *Proceedings of the 1st International Symposium on Pervasive Computing and Applications*, vol. 1, issue 05, pp65-70.
- Teodorovic D., A., (2006). "Intelligent Parking Systems", *Eur. J. Operat. Res.*, vol. 03, issue 5, pp1666-1682.